



Haier

Haier

MRV 50/60Hz R410a

2016 General Catalogue

Haier Commercial Air Conditioning

2016 General Catalogue

MRV 50/60Hz R410a

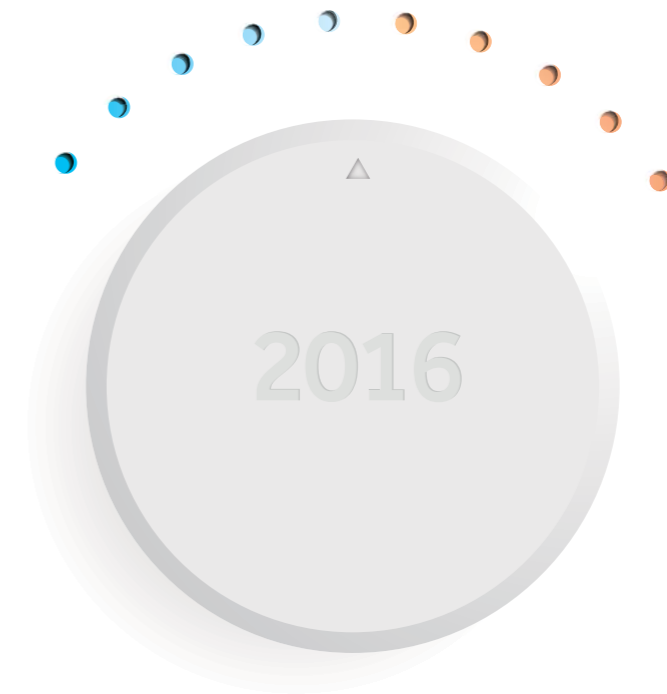

Haier Commercial Air Conditioning



ADDRESS

No.1 Haier Road, Hi-tech Zone, Qingdao 266101 P.R.China

CONTACTS

Tel: +86-532-8893-6938

B2B Website: www.haierac.com

B2C Website: www.haier.com

The specifications, designs and information in this brochure are subject to the actual products.
Haier reserves the right to make change without any notice.



Version 1.0



Haier B2B Platform

The Haier Air-conditioning dealer portal (www.haierac.com) is a platform to help Haier distributors, installer and professional personnels better understand and make business with Haier globally.



The portal becomes the official new product release channel, offering the latest materials of Haier A/C products with high resolution pictures, project reference to help our business partners understand how our solutions help the end users globally.

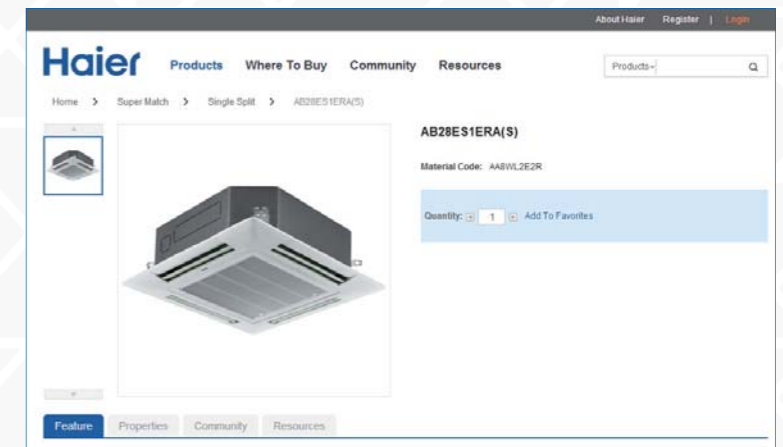

This platform offers an opportunity for our business partners to share projects, applications and other exciting stories with Haier.

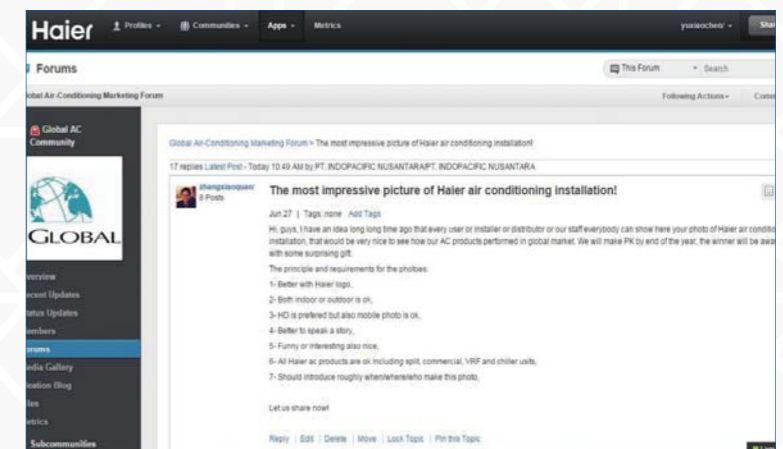

This platform offers a community environment for our business partner to attain valuable resources, including catalogue, brochures, leaflet and other marketing documents. Moreover, the platform is a convenient place where all business partners can communicate with Haier directly.



<http://www.haierac.com>



Haier Global Network

Haier has built up its infrastructures globally to meet the customers' quick evolving demands, including R&D centers, production facilities, trading companies and sales networks etc. Haier's five R&D centers around the world have forged strategic partnerships with first-class suppliers, research institutions, and prestigious universities to create an innovative ecosystem composed of internal and external scientists and engineers connected by virtual and physical networks.



Worldwide Network	Overseas	Global
Trading Company	24	66
R&D Center	4	5
Factory	24	24
Industry Park	7	21
Sales Network	37.683	143.330

Haier Global Revenue

Haier is the #1 brand of Major Appliance in the world, with its global revenue reaching 32.3 billion USD in 2014.

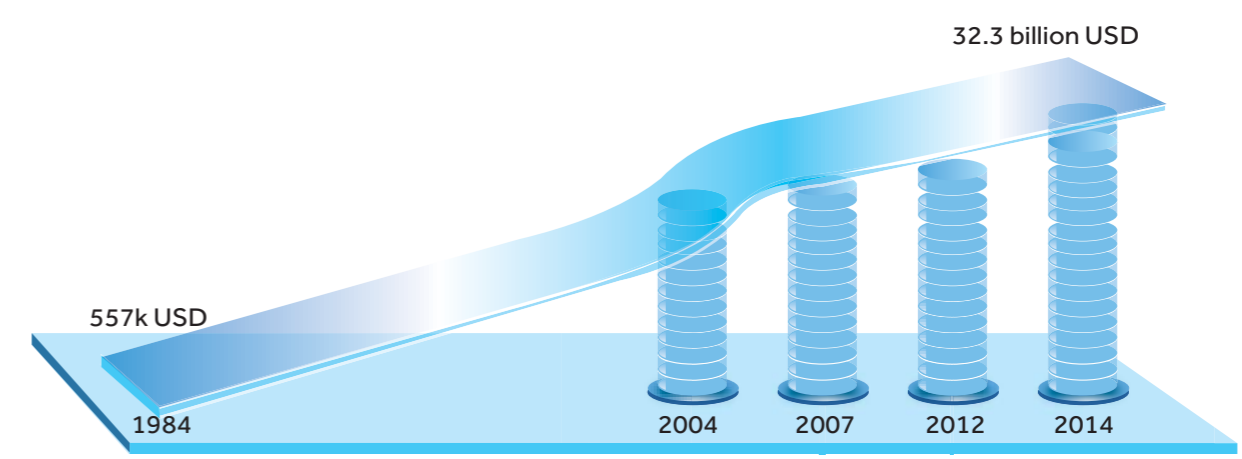

Haier Brand Story

The Internet era is a diverse and unconventional time, where "one size fits all" products and solutions simply aren't enough. Customers want to be treated as individuals and respected for who they are. Everyone wants their unique lifestyle acknowledged. That is why Haier listens closely to you in order to gain a genuine understanding of what is going on in your life and what is on your mind. So each of you can get the smart home experience you deserve: be it simple, sophisticated, organized or enjoyable. As a worldwide industry leader, Haier innovates beyond products and solutions and turns the organization into a wholly connected platform. In doing so, internal and external resources are connected quickly and easily. We believe only by doing so, we can best meet our consumers' expectations in this rapidly evolving world. Be part of the Haier Network. Create new possibilities.

Haier AC Milestones

- Haier AC has been holding **No.1** market share in Pakistan for 5 consecutive years from 2009.
- Haier AC was ranked **NO.5** in Italy by market share in volume in 2012 & 2013 by DATABANK.
- Haier B2C website in Italy was awarded "Interactive Key Award 2013".
- Haier AC entered Winter Olympics in **Sochi** Russia in 2013.

1984
Haier group was founded in Qingdao, China.

1985
Developing China's first split air conditioner.

1993
Developing China's first inverter air conditioner.

1995
Starting to export air conditioners to Europe market.

1996
Launching full range light commercial air conditioning solution.

1998
Launching VRF system with the cooperation with Toshiba.

1999
Starting to export air conditioners to USA.

2001
Building up industry park in Pakistan and catching No.1 market share in 2005.

2005
Releasing R410a DC inverter X-multi system.

2006
Achieving IF design award, one of 10 creative products in the world.

2006
Releasing R410a centrifugal chiller with maglev technology and R410a DC inverter VRF system.

2007
Achieving the bid of 20 projects of Beijing Olympic Games.

2009
Achieving red dot design award.

2010
Introducing the more advanced Freon-free DC inverter air conditioner and magnetically levitated VRF system with high energy efficiency.

2011
Launching full range of SUPER MATCH solutions covering on-off and inverter models as well as mono and multi systems.

2012
Establishing Haier Europe HOME SOLUTION platform at Lyon France to accelerate the marketing of RAC/CAC/Heat pump/Solar solution.

2013
Launching Emperor series and Aero series floor standing models which lead the innovation in design and air supply system.

2014
Establishing AC R&D center to enhance the R&D ability with more focus on users' requirement.

2015
Launching MRV IV full DC INV. technology Max. 3 modular up to 72HP.

Brief of R&D Center

Setting New Standards: Haier's new state of the art HVAC R&D Center commences operation in March, 2014



Driving across the world's longest bridge into the beautiful coastal city of Qingdao and taking the off-ramp to the massive Haier Industrial Park, you will find the world's most advanced HVAC R&D center and its adjacent height drop testing facility towering over other buildings in the park. The commencement of the R&D center puts Haier in the leadership position to provide the best HVAC product solutions suitable for different climates and environments around the globe.

Entering the lobby you will be awed by the installation and display of Haier's world leading magnetic bearing oil free centrifugal chiller that cools the building. Also in display are Haier's latest innovation of residential and commercial products and BMS control solutions.

The 6 story building houses 1,000 plus experienced engineers and technicians, and is equipped with 120 test labs. From psychrometric labs that accurately measure product capacity and efficiency to acoustic labs that reduces sound level; from environment simulators to sustainability test labs that ensure product reliability under the harshest ambient conditions, Haier engineers work hand in hand with international team of experts to turn out green and user friendly climate control solutions.

The height drop test tower, standing 106 meters tall, is the tallest test tower of its kind. It allows Haier's latest MRV products to test under all kinds of installation scenarios.

The stage is set, and Haier is ever more ready to provide global customers with world class products. The new R&D Center is the testament of Haier's commitment and vision in being the leading player in the global HVAC industry.

Global Manufacturing Capacity

Domestically, Haier AC is running 9 factories, 1 of which is MHAQ, a JV between Haier and Mitsubishi Heavy. In overseas markets, Haier is running 7 manufacturing plants. With all these factories, Haier AC has a product capacity amounts to 20.1 million sets per year.





MRV IV (T3)

- Single Module: 8/10/12/14HP, 16/18/20HP
- Combination Module: 22-60HP, 3 modules
- Full DC INVERTER technology
- Max.1000m total pipe length, Max.110m height drop
- Compatible with all the MRV indoor units
- High Ambient Temp. Operation up to 52°C

8/10/12/14HP 16/18/20HP

027



MRV W (208~230V/3Ph/50(60)Hz)

- 208~230V/3Ph/50(60)Hz
- Water Source MRV Outdoor Unit, Combine Water System and Refrigerant System in one System
- 3 Basic Single Module:8/10/12HP, Max 3 Modules
- Combination up to 36HP
- Most Compact Size Outdoor Design in the Industry
- Total 300m Long Pipe Length, Easy for Installation
- Double Coil Outdoor Heat Exchanger
- Compatible with all the MRV Indoor Units

097



MRV S II

- New platform, new outlook.
- Full DC inverter technology, high efficiency
- Low sound level, high comfort.
- High convenience.

4/5/6HP

075



MRV III-RC(208~230V/3Ph/60Hz)

- Power Supply: 3/208~230V/60Hz
- DC Inverter Scroll Compressor & BLDC Fan
- 5 Basic Single Modular Units: 8/ 10/ 12/14/16HP
- Max. 3 Modules Combination up to 48HP
- Max Connected Indoor Units up to 64
- Compatible with all the MRV Indoor Units

8/10HP 12/14/16HP

061



Round-way Smart Air Flow Cassette

- Unique Round-way air outlet, no blind spot
- Innovative 4 independent air flow control
- 6 adjustable louver positions, 1296 air flow combinations
- Move Eye intelligent system, intelligence all around(optional)

119

Home

Hotel

Office

Shop

CONTENTS

MRV 50/60Hz R410a

PRODUCT LINE UP

MRV IV-C
MRV III-C
MRV VIII-RC
MRV S

003
013
033
051
067

MRV W

EASY MRV CONNECTION KIT
MRV AHU CONNECTION KIT
MRV INDOOR
CONTROL SYSTEM
REFERENCE PROJECTS

083
103
111
119
143
173

HAIER MRV Milestone

Haier, as China's earliest VRF practitioners, has been always committed to the extreme pursuit to VRF system











PRODUCT LINE-UP (Outdoor Units)



Series	HP	8	10	12	14	16	18	20	22	24	26	28	30	32	34	36		38	40	42	44	46	48	50	52	54	56	58	60	62	64	66	68	70	72
MRV IV-C (T1)	3/380-400/50 3/380-400/60																																		
NEW MRV IV-C (T3)	3/380-400/50 3/380-400/60																																		

Series	HP	8	10	12	14	16	18	20	22	24	26		28	30	32	34	36	38	40	42	44	46	48
MRVIII-C (T1)	3/380-400/50 3/380-400/60																						
	3/208-230/60																						
	3/460/60																						
MRVIII-C (T3)	3/380-400/50 3/380-400/60																						
MRVIII-RC	3/380-400/50 3/380-400/60 3/208-230/60 NEW																						

PRODUCT LINE-UP (Outdoor Units)

Series	HP	3	4	5	6	7	8	10	12	14	16	18	20	22	24	26	28	30	32	34	36	38	40	42	44	46	48	
MRV S'	1/220-230/50																											
	1/220-230/50/60																											
	3/380-400/50/60																											
NEW MRV S''	1/220-230/50/60																											
	3/380-400/50/60																											
MRV W	3/380-400/50 3/380-400/60 3/208-230/60 NEW																											





EASY MRV

MODEL	MS1-036A	MS1-060A	MS3-036A
Match with indoor	1 by 1	1 by 1	1 by 3
EASY MRV Connection Kit			
Capacity(Btu/h)	≤36K	36K<X≤60K	Every indoor capacity ≤36K
MRV series	MRV S, MRV III-C	MRV S, MRV III-C	MRV S, MRV III-C











DX AHU Connection Kit

MODEL	AH1-280A	AH1-560A
CAPACITY	14 ≤ x ≤ 28 kW	28 < x ≤ 56 kW
MRV series	MRV S(8/10/12HP), MRV III-C	MRV S(8/10/12HP), MRV III-C

PRODUCT LINE-UP

Series	KBTU/h kW		7	9	12	16	18	24	28	30	38	48	60	72	96
			2.2	2.8	3.6	4.5	5.6	7.1	8	9	11.2	14	16	22.6	28
AQUA Hi-Wall (Need match with EASY MRV connection Kit MS1-036A, MS3-036A)		AS**QS2HRA	●	●	●		●								
N F series (Need match with EASY MRV connection Kit MS1-036A, MS3-036A)		AS**NS1HRA	●	●	●		●	●							
N H series (Need match with EASY MRV connection Kit MS1-036A, MS3-036A)		AS**BS4HRA	●	●	●	●	●	●							
Zircon Hi-Wall (Need match with EASY MRV connection Kit MS1-036A, MS3-036A)		AS**ZB1ERA	●	●	●		●	●							
Console (Need match with EASY MRV connection Kit MS1-036A, MS3-036A)		AF*AS1ERA		●	●										
High wall EEV Inside		AS**2MSERA	●	●	●	●	●	●							
Console (EEV inside)		AF*MAERA	●	●	●		● (5.0)								
2 Way cassette		AB**2MBERA	●	●	●	●	●								
Cassette		AB**2MCERA		●	●	●	●	●	●	●	●	●			
NEW 360° Smart Air Flow Cassette		AB**2MRERA	●	●	●	●	●	●	●	●	●	●	●		

PRODUCT LINE-UP

Series	KBTU/h Kw		7	9	12	16	18	24	28	30	38	48	72	96
			2.2	2.8	3.6	4.5	5.6	7.1	8	9	11.2	14	22.6	28
Convertible		AC**2MCERA AC**2MFERA		●	●	●	●	●	●	●	●	●		
Slim ESP duct(30Pa)		AD**2MSERA	●	●	●	●	●	●						
Low ESP duct(20Pa)		AD**2MLERA	●	●	●	●	●	●						
Middle ESP duct(50Pa)		AD**2MMERA					●	●	●	●	●	●		
Medium ESP duct (80Pa)		AD**2MNERA								●	●	●		
High ESP duct		AD**2MHERA					●	●	●	●	●	●	●	●
Built-in floor standing		AE**2MLERA	●	●	●	●	●	●						
Fresh air duct		AD*MPERA										●	●	●
HRV (Heat Reclaim Ventilation) (ERV0150/0260/0800/1000ANN)	 150m ³ /h 260m ³ /h													
	 800m ³ /h 1000m ³ /h													



MRV IV-C

| 013 Features & Benefits
| 023 MRV IV Outdoor

FEATURES & BENEFITS

Full DC Inverter High Efficiency

- 1 Full DC Inverter technology
- 2 Key parts to support full DC inverter technology
- 3 High efficiency

Full DC inverter technology

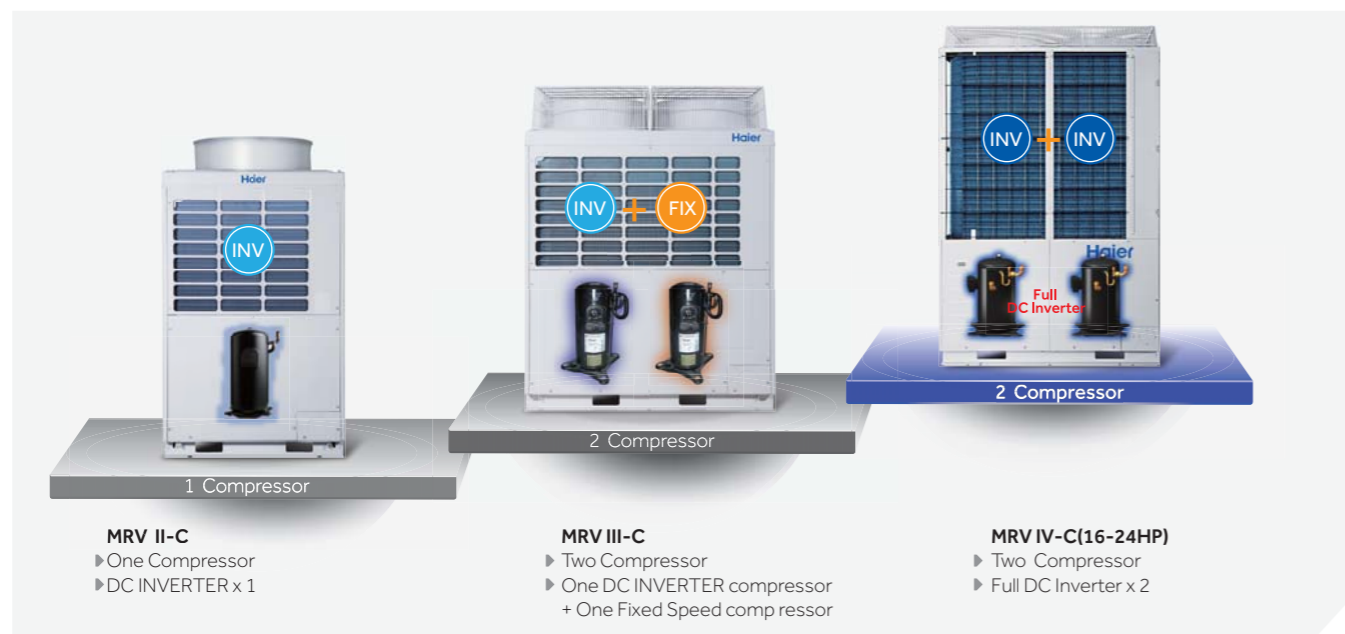

Full new outlook, full DC inverter technology key parts

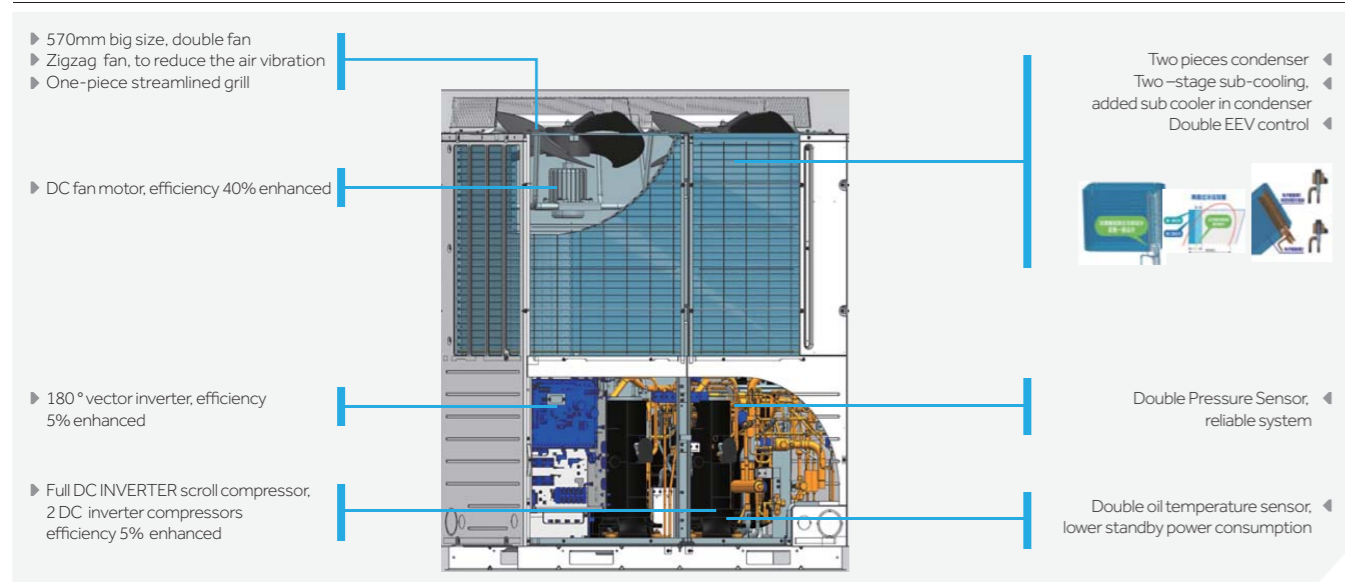

IPLV(c) up to 8.2, average IPLV(c) up to 7.7, low running cost

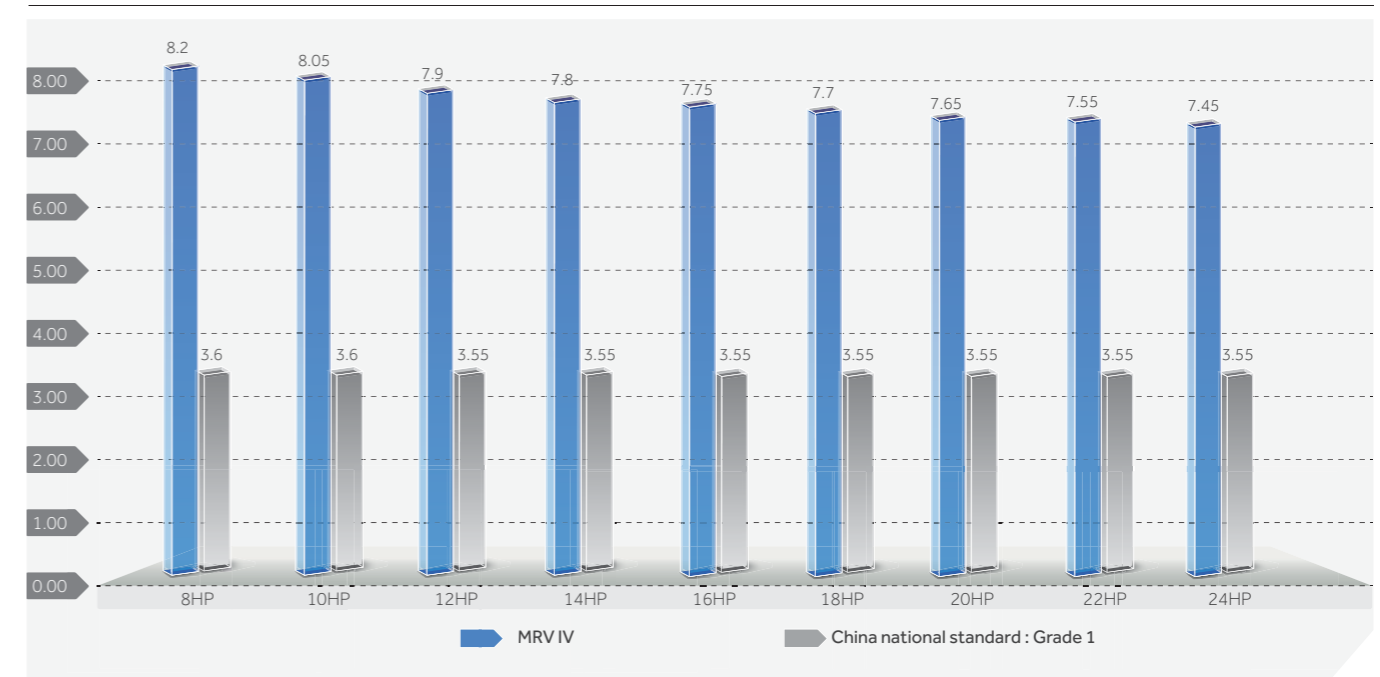

Higher energy efficiency than MRV III

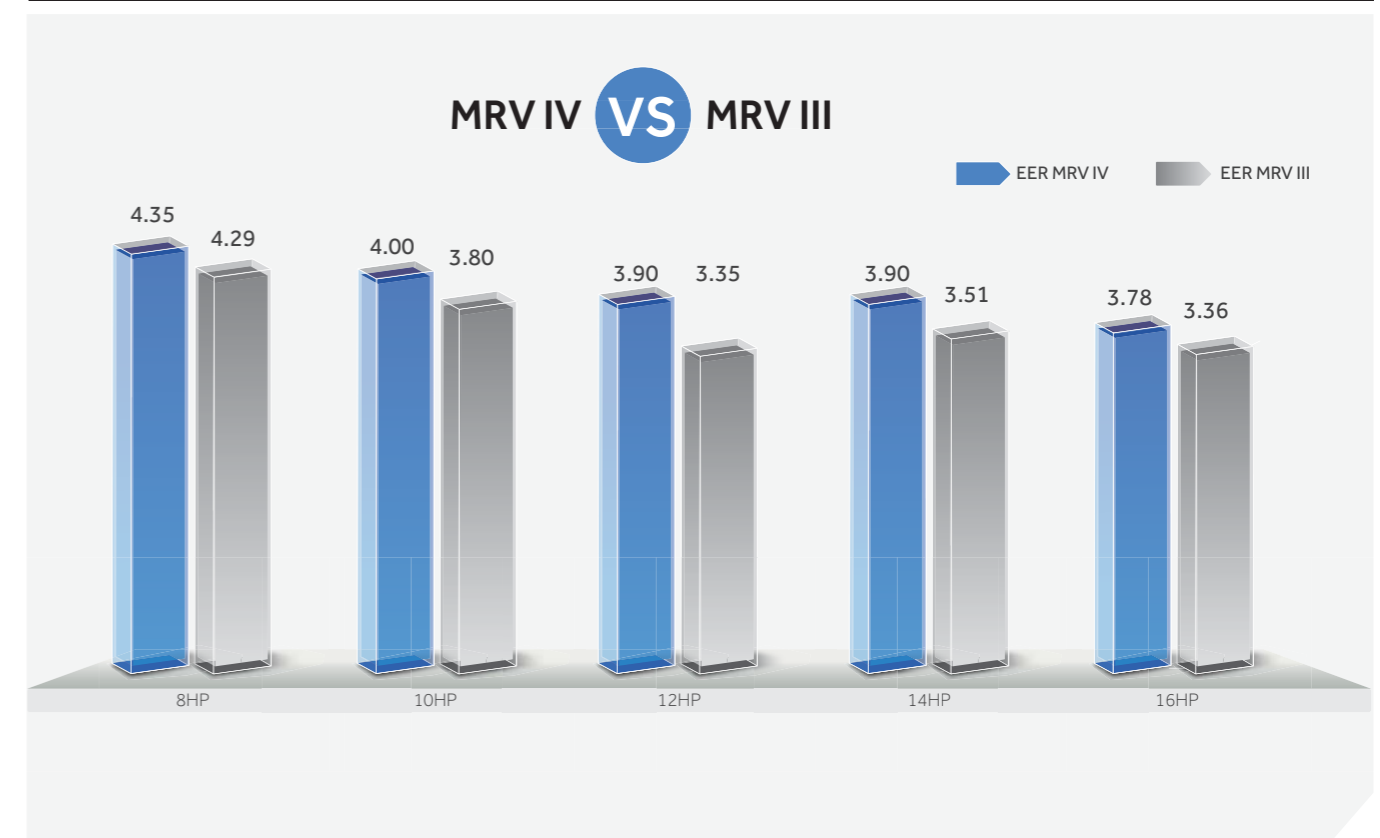

FEATURES & BENEFITS

Easy Installation

- 1 Largest capacity single module, smallest footprint
- 2 Long pipe length, high height drop
- 3 High outdoor ESP

Largest capacity single module in the industry: 24HP ,
Smallest footprint in the industry : 0.97m²

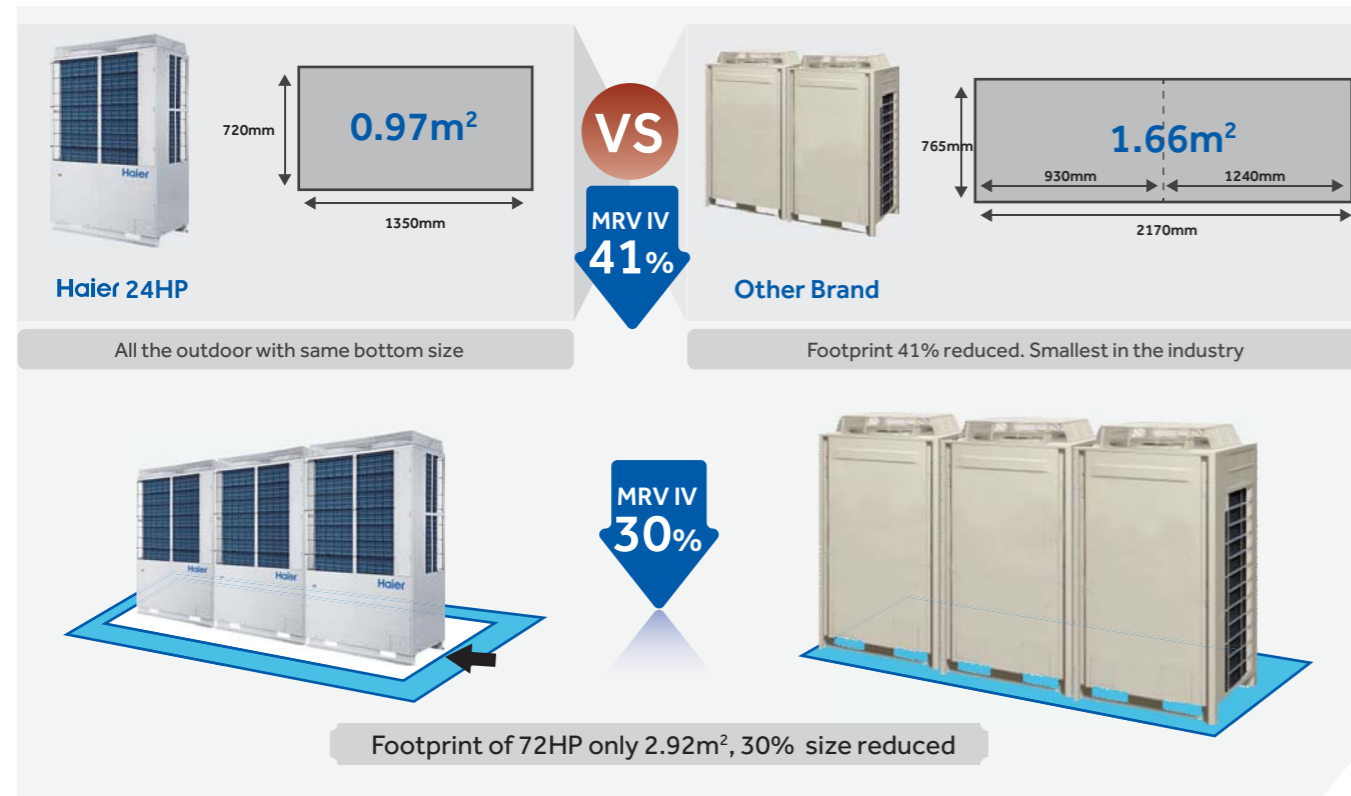

82Pa ESP, Long air duct connecting available



Long pipe length, high height drop



- Max. pipe length **1000m**^{*1} Standard 500m
- Max. Single pipe length **165m** (equivalent pipe **190m**)
- Max. Height drop between ID and OD **Max. 110m/90m**^{*2} Standard 50m/40m
- Max height drop between ID **Max 30m**^{*3} (Standard 18m)

^{*1} ^{*2} ^{*3} Need contact your local distributor/dealer for individual design.

FEATURES & BENEFITS

Comfort

- 1 Wide operation range
- 2 Low noise, night silent running
- 3 Optimal temperature control

Wide operation range, -23°C heating, 53°C cooling

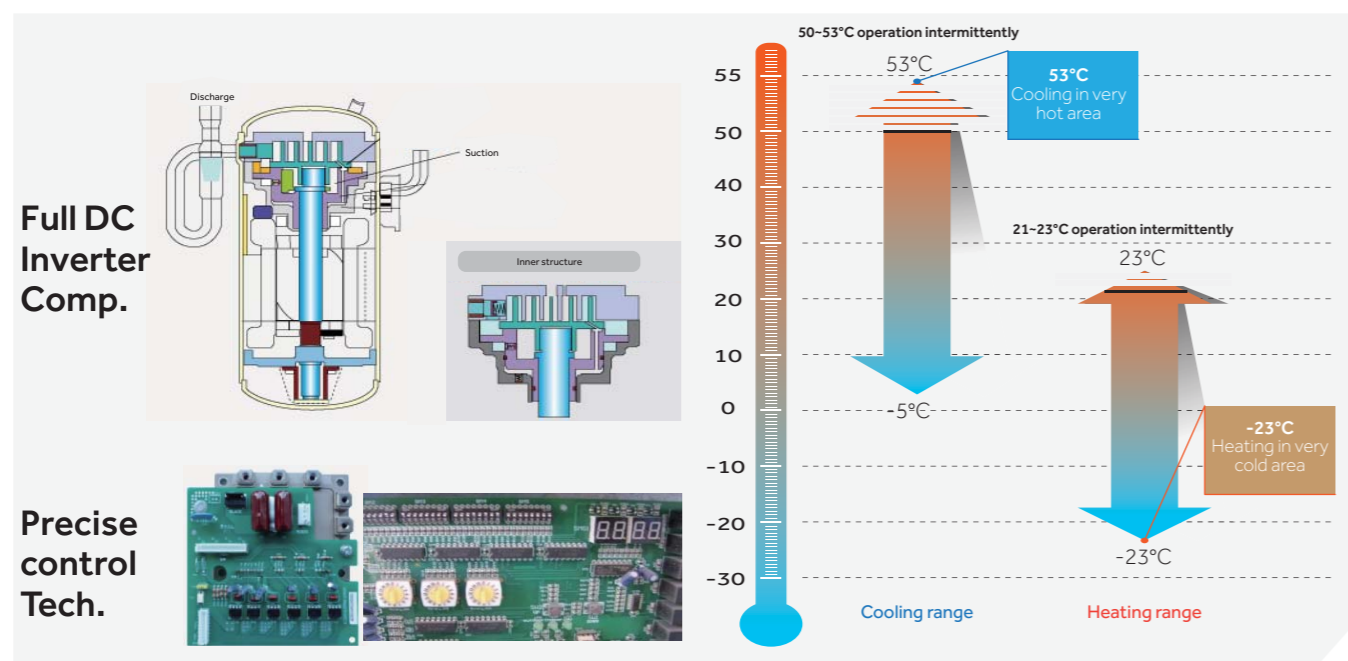

Low noise and night silent running

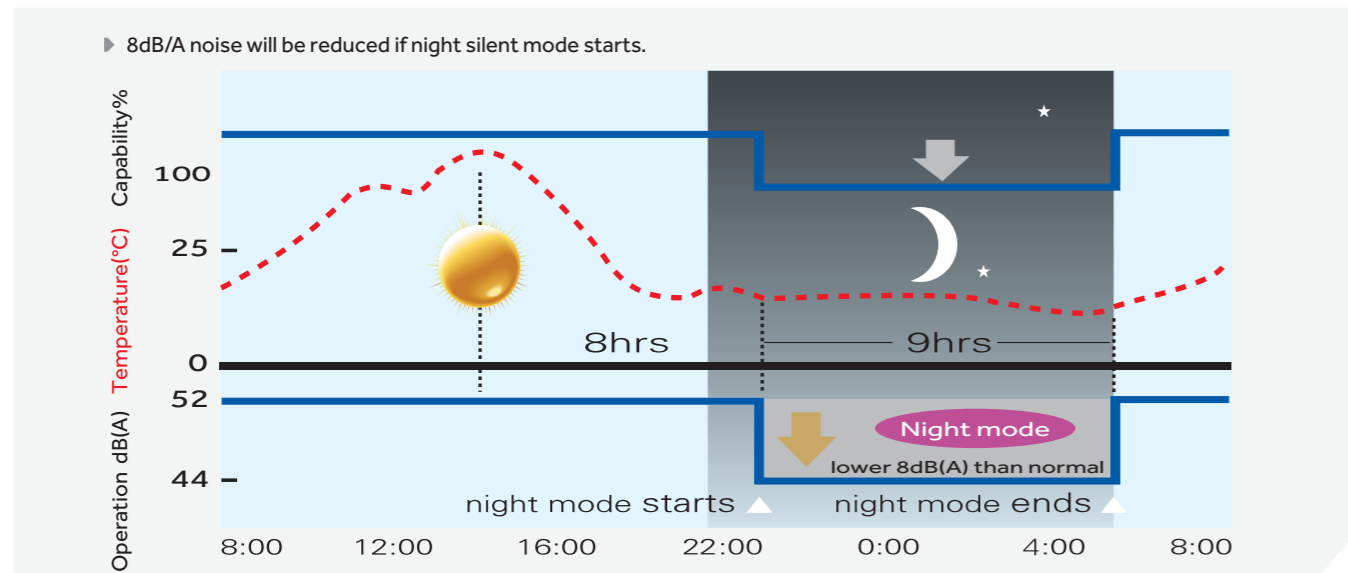

Optimal Temperature Control

- ▶ When a multiple number of indoor units are connected, an insufficient or excess amount of refrigerant may be supplied to indoor units depending on the difference in length of the piping connection from outdoor units
- ▶ Optimal refrigerant control uses the indoor coil temperature to detect the air conditioning status of each indoor unit and control the capacity(refrigerant amounts) very precisely

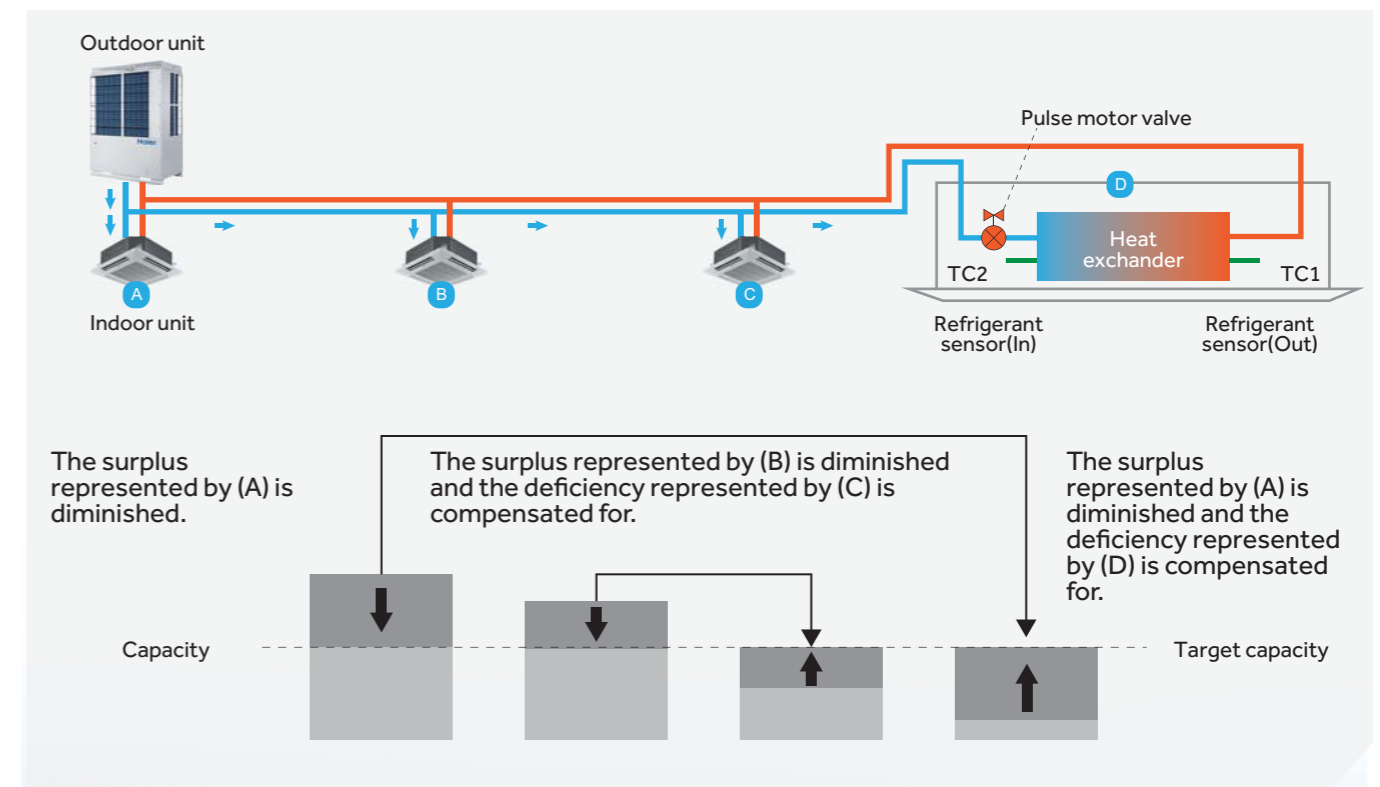

FEATURES & BENEFITS

High Reliability

- 1 Recycling operation
- 2 2 stage oil return
- 3 Oil temperature sensor
- 4 Double Pressure sensor
- 5 Thunder Protection

Recycling operation

Recycling operation, longer life of compressor

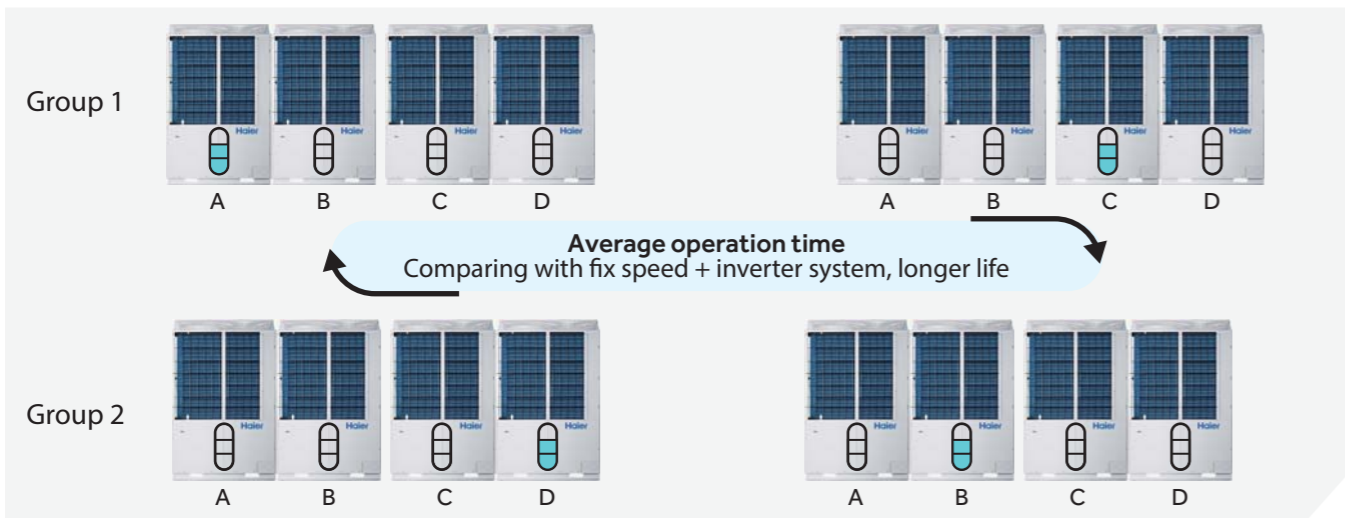

Oil Return

If the compressor operate at low frequency, oil return is only through the capillary. If the compressor operate at high frequency, oil return is through the capillary and magnetic valve.

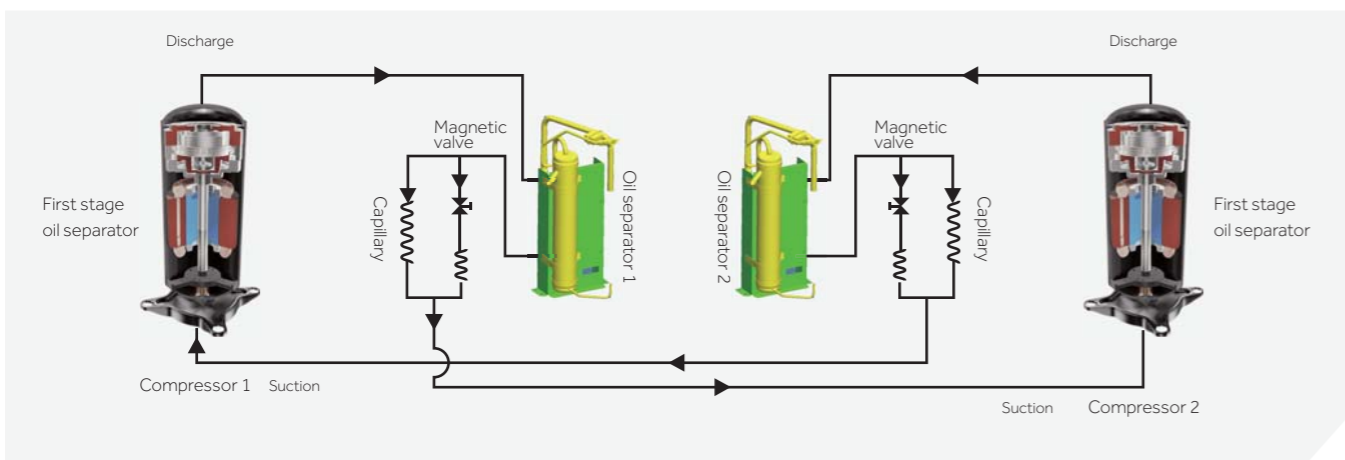

Compressor double protection

Base on the basic gas discharge sensor, MRV IV add the oil temperature sensor at the bottom of compressor.

- With the oil temperature sensor
- Control the on/off of heater of compressor, preventing from the liquid shock of compressor
- Judge if the liquid refrigerant enter into the compressor
- Compressor oil sub heating protection.
- High pressure sensor for every compressor so for the module with 2 compressors ,there are 2 high pressure sensors and 1 low pressure sensors, total 3 sensors

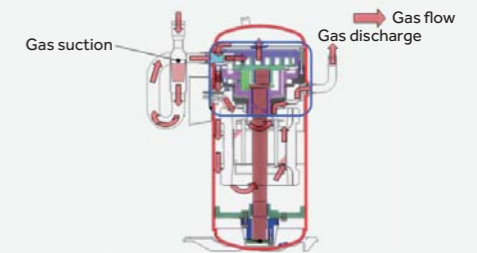

Thunder protection

There are electricity discharge wire in the terminal block, to lead the abnormal voltage into the earth, then to prevent the thunder affect.



Cloud Service Platform

- 1 Cloud Service

Cloud Service



- 7*24 on-line service
- Intelligent service: failure remind, maintenance mind information
- Energy saving: real-time data saving, provide energy saving solution according to data analysis.

50/60Hz-380~400V-3Ph



8/10/12/14/16HP



18/20/22/24HP



- Single Module: 8/10/12/14/16HP, 18/20/22/24HP
- Combination Module: 26-72HP, 2-3 modules
- Full DC INVERTER technology
- Max. 1000m total pipe length, Max. 110m height drop
- Compatible with all the MRV indoor units.



Model		AV08NMMEA	AV10NMMEA	AV12NMMEA	AV14NMMEA	AV16NMMEA	AV18NMMEA	AV20NMMEA	AV22NMMEA	AV24NMMEA	AV26NMMEA	AV28NMMEA	AV30NMMEA	AV32NMMEA	AV34NMMEA	AV36NMMEA	AV38NMMEA	AV40NMMEA	AV42NMMEA	AV44NMMEA	AV46NMMEA	AV48NMMEA	
Combination model		/	/	/	/	/	/	/	/	/	/	/	/	/	/	/	/	/	/	/	/	/	/
Capacity	Capacity range	HP	8	10	12	14	16	18	20	22	24	26	28	30	32	34	36	38	40	42	44	46	48
	Cooling	Rated power input	kW	5.79	7.00	8.59	10.26	11.90	13.62	15.56	17.57	19.71	22.16	25.53	29.53	34.11	39.11	44.11	49.11	54.11	59.11	64.11	69.11
	Heating	Rated power input	kW	27.3	31.5	37.5	45	50	56.5	63	69	73	82.5	90	95	101.5	106.5	113	119.5	126	132	136	142
Electrical parameters	Power supply	Ph/V/Hz	3/380-400/50/60	3/380-400/50/60	3/380-400/50/60	3/380-400/50/60	3/380-400/50/60	3/380-400/50/60	3/380-400/50/60	3/380-400/50/60	3/380-400/50/60	3/380-400/50/60	3/380-400/50/60	3/380-400/50/60	3/380-400/50/60	3/380-400/50/60	3/380-400/50/60	3/380-400/50/60	3/380-400/50/60	3/380-400/50/60	3/380-400/50/60	3/380-400/50/60	3/380-400/50/60
	Cooling	Rated power input	kW	5.79	7.00	8.59	10.26	11.90	13.62	15.56	17.57	19.71	22.16	25.53	29.53	34.11	39.11	44.11	49.11	54.11	59.11	64.11	69.11
		Max power input	kW	14.02	14.38	14.73	16.91	22.68	22.10	25.19	30.56	37.47	31.64	33.81	39.59	39.00	44.78	47.87	47.28	50.37	55.75	62.66	68.03
		Rated current	A	9.57	11.56	14.19	16.94	19.66	22.50	25.69	29.02	32.55	31.12	33.88	36.60	39.43	42.16	45.35	48.19	51.38	54.71	58.24	61.57
	Heating	Max current	A	23.09	23.68	25.1	28.4	36.8	36.15	41.1	49.65	60.45	53.5	56.8	65.2	64.55	72.95	77.9	77.25	82.2	90.75	101.55	110.1
		Rated power input	kW	6.00	7.08	8.72	10.71	12.05	13.95	15.95	18.16	19.47	19.44	21.43	22.76	24.66	26.00	28.00	29.90	31.90	34.11	35.42	37.62
		Max power input	kW	12.72	13.23	13.68	15.60	17.20	22.68	25.19	27.72	28.62	29.28	31.20	32.80	38.28	39.88	42.39	47.87	50.37	52.91	53.81	56.34
	EER	Rated current	A	9.91	11.69	14.40	17.69	19.90	23.04	26.34	29.99	32.15	32.10	35.39	37.59	40.73	42.94	46.24	49.38	52.68	56.33	58.49	62.14
		Max current	A	20.95	21.79	22.1	25.2	27.88	37.8	42	46.05	47.4	47.3	50.4	53.08	63	65.68	69.88	79.8	84	88.05	89.4	93.45
	COP			4.35	4.00	3.90	3.90	3.78	3.70	3.60	3.50	3.45	3.90	3.90	3.84	3.79	3.74	3.68	3.65	3.60	3.55	3.52	3.47
Performance	Air flow (H)	m ³ /h	C:15000/H:13200	C:15000/H:13200	C:15000/H:13200	C:15000/H:13200	C:15600/H:14400	C:16200/H:15000	C:16200/H:15000	C:16200/H:15000	C:16200/H:15000	C:30000/H:26400	C:30000/H:26400	C:30600/H:27600	C:31200/H:28200	C:31480/H:29400	C:31480/H:29400	C:32400/H:30000	C:32400/H:30000	C:32400/H:30000	C:32400/H:30000	C:32400/H:30000	C:32400/H:30000
	Sound pressure level (H)	dB(A)	57	57	59	59.5	61	62	62	62	63	62	62.5	63	64	64.5	64.5	65	65	65	65.5	65.5	66
	Sound power level (H)	dB(A)	73	73	75	76	77	79	79	79	79	80	79	80	80	81	82	82	83	83	83	83	84
Installation	External dimensions (W/D/H)	mm	1350*720*1690	1350*720*1690	1350*720*1690	1350*720*1690	1350*720*1690	1350*720*2048	1350*720*2048	1350*720*2048	1350*720*2048	1350*720*1690	1350*720*1690*2	1350*720*1690	1350*720*1690	1350*720*1690	1350*720*1690	1350*720*2048	1350*720*2048*2	1350*720*2048	1350*720*2048	1350*720*2048	1350*720*2048*2
	Shipping dimensions (W/D/H)	mm	1450*826*1885	1450*826*1885	1450*826*1885	1450*826*1885	1450*826*1885	1450*826*2225	1450*826*2225	1450*826*2225	1450*826*2225	1450*826*1885	1450*826*1885*2	1450*826*1885	1450*826*1885	1450*826*1885	1450*826*1885	1450*826*2225	1450*826*2225*2	1450*826*2225	1450*826*2225	1450*826*2225	1450*826*2225*2
	Net/Shipping weight	kg	276/301	276/301	276/301	279/304	321/346	335/360	335/360	359/384	359/384	276/301	279/304*2	279/304	279/304+321/346	321/346+335/360	321/346+335/360	335/360+359/384	335/360*2	335/360+359/384	335/360+359/384	359/384+359/384	(359/384)*2
	Compressor type		DC INV. SCROLL	DC INV. SCROLL	DC INV. SCROLL	DC INV. SCROLL	DC INV. SCROLL	DC INV. SCROLL	DC INV. SCROLL	DC INV. SCROLL	DC INV. SCROLL	DC INV. SCROLL	DC INV. SCROLL	DC INV. SCROLL	DC INV. SCROLL	DC INV. SCROLL	DC INV. SCROLL	DC INV. SCROLL	DC INV. SCROLL	DC INV. SCROLL	DC INV. SCROLL	DC INV. SCROLL	DC INV. SCROLL
	Compressor brand		MITSUBISHI ELECTRIC	MITSUBISHI ELECTRIC	MITSUBISHI ELECTRIC	MITSUBISHI ELECTRIC	MITSUBISHI ELECTRIC	MITSUBISHI ELECTRIC	MITSUBISHI ELECTRIC	MITSUBISHI ELECTRIC	MITSUBISHI ELECTRIC	MITSUBISHI ELECTRIC	MITSUBISHI ELECTRIC	MITSUBISHI ELECTRIC	MITSUBISHI ELECTRIC	MITSUBISHI ELECTRIC	MITSUBISHI ELECTRIC	MITSUBISHI ELECTRIC	MITSUBISHI ELECTRIC	MITSUBISHI ELECTRIC	MITSUBISHI ELECTRIC	MITSUBISHI ELECTRIC	MITSUBISHI ELECTRIC
	Compressor quantity		1INV	1INV	1INV	1INV	2INV	2INV	2INV	2INV	2INV	1INV+1INV	1INV*2	1INV+2INV	1INV+2INV	2INV+2INV	2INV+2INV	2INV+2INV	2INV+2INV	2INV*2	2INV+2INV	2INV+2INV	2INV+2INV
	Refrigerant type		R410A	R410A	R410A	R410A	R410A	R410A	R410A	R410A	R410A	R410A	R410A	R410A	R410A	R410A	R410A	R410A	R410A	R410A	R410A	R410A	R410A
	Refrigerant charge	kg	9.7	9.7	9.7	10	10	10	10	10	10	19.7	20	20	20	20	20	20	20	20	20	20	20
	Refrigerant liquid pipe	mm	9.52	9.52	12.7	12.7	12.7	12.7	12.7	12.7	12.7	15.88	15.88	15.88	15.88	15.88	15.88	19.05	19.05	19.05	19.05	19.05	19.05
	Refrigerant gas pipe	mm	19.05	22.22	25.4	28.58	28.58	28.58	28.58	28.58	28.58	31.8	31.8	31.8	31.8	31.8	31.8	38.1	38.1	38.1	38.1	38.1	38.1
Oil equalization pipe	mm	9.52	9.52	9.52	9.52	9.52	9.52	9.52	9.52	9.52	9.52	9.52	9.52	9.52	9.52	9.52	9.52	9.52	9.52	9.52	9.52	9.52	
Max. total pipe length *1	m	1000	1000	1000	1000	1000	1000	1000	1000	1000	1000	1000	1000	1000	1000	1000	1000	1000	1000	1000	1000	1000	
Standard total pipe length *2	m	500	500	500	500	500	500	500	500	500	500	500	500	500	500	500	500	500	500	500	500	500	
Max. pipe length (Equivalent/Actual)	m	190/165	190/165	190/165	190/165	190/165	190/165	190/165	190/165	190/165	190/165	190/165	190/165	190/165	190/165	190/165	190/165	190/165	190/165	190/165	190/165	190/165	
Max drop between I.U.&O.U (O.U up/down) *3	m	110/90	110/90	110/90	110/90	110/90	110/90	110/90	110/90	110/90	110/90	110/90	110/90	110/90	110/90	110/90	110/90	110/90	110/90	110/90	110/90	110/90	
Standard drop between I.U.&O.U *4	m	50/40	50/40	50/40	50/40	50/40	50/40	50/40	50/40	50/40	50/40	50/40	50/40	50/40	50/40	50/40	50/40	50/40	50/40	50/40	50/40	50/40	
Max drop between I.U. *5	m	30	30	30	30	30	30	30	30	30	30	30	30	30	30	30	30	30	30	30	30	30	
Standard drop between I.U. *6	m	18	18	18	18	18	18	18	18	18	18	18	18	18	18	18	18	18	18	18	18	18	
External static pressure	Pa	82	82	82	82	82	82	82	82	82	82	82	82	82	82	82	82	82	82	82	82	82	
Connection ratio	Connectable indoor unit ratio	%	50-160	50-160	50-160	50-160	50-160	50-160	50-160	50-160	50-160	50-160	50-160	50-160	50-160	50-160	50-160	50-160	50-160	50-160	50-160	50-160	
	Maximum number of indoor units		18	20	24	29	33	37	41	45	49	53	58	62	64	64	64	64	64	64	64	64	
Working temp.	Cooling	°C	(-5-50)																				
	Heating	°C	(-23-21)																				

Max. total pipe length *1: If the total pipe length to all the indoor units is between 500-1000m, you MUST contact your local distributor/dealer for individual design and separate order.
 Standard total pipe length *2: Standard design and production in the factory.
 Max drop between I.U.&O.U *3: If the height difference between the outdoor and the indoor units is from 50 to 110m, you MUST contact your local distributor/dealer for individual design and production.
 Standard drop between I.U.&O.U *4: Standard design and production in the factory.
 Max drop between I.U. *5: If the height difference between the indoor units is from 18 to 30m, you MUST contact your local distributor/dealer for individual design and production.
 Standard drop between I.U. *6: Standard design and production in the factory.

* All the specifications are tested under nominal condition (in cooling, indoor temp. is 27 °C DB/19 °C WB; outdoor temp 35 °C DB/24WB; in heating, indoor temp. is 20 °C DB; in heating, outdoor temp. is 7 °C DB/6 °C WB)

MRV IV-C
MRV III-C
MRV III-RC
MRV S
MRV W
Easy MRV
MRV AHU
MRV Indoor
Control System
Reference Projects

50/60Hz-380~400V-3Ph



72HP



- Single Module: 8/10/12/14/16HP, 18/20/22/24HP
- Combination Module: 26-72HP, 2-3 modules
- Full DC INVERTER technology
- Max. 1000m total pipe length, Max. 110m height drop
- Compatible with all the MRV indoor units.



Model		AV50NMMEUA	AV52NMMEUA	AV54NMMEUA	AV56NMMEUA	AV58NMMEUA	AV60NMMEUA	AV62NMMEUA	AV64NMMEUA	AV66NMMEUA	AV68NMMEUA	AV70NMMEUA	AV72NMMEUA		
Combination model		AV14NMMEUA	AV16NMMEUA	AV16NMMEUA	AV16NMMEUA	AV18NMMEUA	AV20NMMEUA	AV20NMMEUA	AV20NMMEUA	AV20NMMEUA	AV20NMMEUA	AV22NMMEUA	AV24NMMEUA		
		AV18NMMEUA	AV16NMMEUA	AV18NMMEUA	AV20NMMEUA	AV20NMMEUA	AV20NMMEUA	AV20NMMEUA	AV20NMMEUA	AV22NMMEUA	AV24NMMEUA	AV24NMMEUA	AV24NMMEUA		
		AV18NMMEUA	AV20NMMEUA	AV20NMMEUA	AV20NMMEUA	AV20NMMEUA	AV20NMMEUA	AV22NMMEUA	AV24NMMEUA	AV24NMMEUA	AV24NMMEUA	AV24NMMEUA	AV24NMMEUA		
Capacity	Capacity range	HP	50	52	54	56	58	60	62	64	66	70	72		
	Cooling	kW	140.8	146	151.4	157	162.4	168	173.5	180	185.5	192	197.5	204	
	Heating	kW	158	163	169.5	176	182.5	189	195	199	205	209	215	219	
Electrical parameters	Power supply	Ph/V/Hz	3/380-400/50/60	3/380-400/50/60	3/380-400/50/60	3/380-400/50/60	3/380-400/50/60	3/380-400/50/60	3/380-400/50/60	3/380-400/50/60	3/380-400/50/60	3/380-400/50/60	3/380-400/50/60		
	Cooling	Rated power input	kW	37.50	39.37	41.08	43.02	44.73	46.67	48.68	50.82	52.84	54.98	56.99	59.13
		Max power input	kW	61.10	70.55	69.96	73.05	72.47	75.56	80.93	87.84	93.22	100.13	105.50	112.41
		Rated current	A	61.93	65.01	67.85	71.04	73.88	77.07	80.40	83.93	87.26	90.79	94.12	97.65
	Heating	Rated power input	kW	38.62	40.05	41.95	43.95	45.85	47.85	50.06	51.37	53.57	54.88	57.09	58.40
		Max power input	kW	60.96	59.59	65.07	67.57	73.05	75.56	78.09	78.99	81.53	82.43	84.96	85.86
		Rated current	A	63.77	66.14	69.28	72.58	75.72	79.02	82.67	84.83	88.48	90.64	94.29	96.45
		Max current	A	100.8	97.76	107.68	111.88	121.8	126	130.05	131.4	135.45	136.8	140.85	142.2
		EER		3.75	3.71	3.69	3.65	3.63	3.60	3.56	3.54	3.51	3.49	3.47	3.45
		COP		4.09	4.07	4.04	4.00	3.98	3.95	3.90	3.87	3.83	3.81	3.77	3.75
Performance	Air flow (H)	m ³ /h	C:44440/H:43200	C:44440/H:43480	C:48000/H:44400	C:48000/H:44400	C:48600/H:45000	C:48600/H:45000	C:48600/H:45000	C:48600/H:45000	C:48600/H:45000	C:48600/H:45000	C:48600/H:45000		
	Sound pressure level (H)	dB(A)	66	66	66.5	66.5	67	67	67	67	67.5	67.5	68		
	Sound power level (H)	dB(A)	84	84	85	85	85	85	85	85	86	86	86		
Installation	External dimensions (W/D/H)	mm	1350×720×1690	(1350×720×1690)*2	(1350×720×1690)+ (1350×720×2048)	(1350×720×1690)+ (1350×720×2048)	(1350×720×2048)	(1350×720×2048)*3	(1350×720×2048)*2	(1350×720×2048)*2	(1350×720×2048)+ (1350×720×2048)	(1350×720×2048)	(1350×720×2048)	(1350×720×2048)*3	
		mm	1450×826×1885	(1450×826×1885)*2	(1450×826×1885)+ (1450×826×2225)	(1450×826×1885)+ (1450×826×2225)	(1450×826×2225)	(1450×826×2225)*3	(1450×826×2225)*2	(1450×826×2225)*2	(1450×826×2225)+ (1450×826×2225)	(1450×826×2225)*2	(1450×826×2225)*2	(1450×826×2225)*3	
	Shipping dimensions (W/D/H)	mm	1450×826×1885	(1450×826×1885)*2	(1450×826×1885)+ (1450×826×2225)	(1450×826×1885)+ (1450×826×2225)	(1450×826×2225)	(1450×826×2225)*3	(1450×826×2225)*2	(1450×826×2225)*2	(1450×826×2225)+ (1450×826×2225)	(1450×826×2225)*2	(1450×826×2225)*2	(1450×826×2225)*3	
	Net/Shipping weight	kg	279/304+(335/360)*2	(321/346)*2+(335/360)	(321/346)+(335/360)+(335/360)	(321/346)+(335/360)*2	(335/360)+(335/360)*2	(335/360)*3	(335/360)*2+(359/384)	(335/360)+3(359/384)	(335/360)+(335/360)+(359/384)	(335/360)+(335/360)+(359/384)*2	(335/360)+(359/384)*2	(359/384)*3	
	Compressor type		DC INV. SCROLL	DC INV. SCROLL	DC INV. SCROLL	DC INV. SCROLL	DC INV. SCROLL	DC INV. SCROLL	DC INV. SCROLL	DC INV. SCROLL	DC INV. SCROLL	DC INV. SCROLL	DC INV. SCROLL		
	Compressor brand		MITSUBISHI ELECTRIC	MITSUBISHI ELECTRIC	MITSUBISHI ELECTRIC	MITSUBISHI ELECTRIC	MITSUBISHI ELECTRIC	MITSUBISHI ELECTRIC	MITSUBISHI ELECTRIC	MITSUBISHI ELECTRIC	MITSUBISHI ELECTRIC	MITSUBISHI ELECTRIC	MITSUBISHI ELECTRIC		
	Compressor quantity		1INV+2INV*2	2INV*2+2INV	2INV+2INV+2INV	2INV+2INV*2	2INV+2INV*2	2INV*3	2INV*2+2INV	2INV*2+2INV	2INV+2INV+2INV	2INV+2INV*2	2INV+2INV*2		
	Refrigerant type		R410A	R410A	R410A	R410A	R410A	R410A	R410A	R410A	R410A	R410A	R410A		
	Refrigerant charge	kg	30	30	30	30	30	30	30	30	30	30	30		
	Refrigerant liquid pipe	mm	22.22	22.22	22.22	22.22	22.22	22.22	22.22	22.22	22.22	22.22	22.22		
Refrigerant gas pipe	mm	41.3	41.3	41.3	41.3	41.3	44.5	44.5	44.5	44.5	44.5	44.5			
Oil equalization pipe	mm	9.52	9.52	9.52	9.52	9.52	9.52	9.52	9.52	9.52	9.52	9.52			
Max. total pipe length *1	m	1000	1000	1000	1000	1000	1000	1000	1000	1000	1000	1000			
Standard total pipe length *2	m	500	500	500	500	500	500	500	500	500	500	500			
Max. pipe length (Equivalent/Actual)	m	190/165	190/165	190/165	190/165	190/165	190/165	190/165	190/165	190/165	190/165	190/165			
Max drop between I.U.&O.U (O.U up/down) *3	m	110/90	110/90	110/90	110/90	110/90	110/90	110/90	110/90	110/90	110/90	110/90			
Standard drop between I.U.&O.U*4	m	50/40	50/40	50/40	50/40	50/40	50/40	50/40	50/40	50/40	50/40	50/40			
Max drop between I.U. *5	m	30	30	30	30	30	30	30	30	30	30	30			
Standard drop between I.U.*6	m	18	18	18	18	18	18	18	18	18	18	18			
External static pressure	Pa	82	82	82	82	82	82	82	82	82	82	82			
Connection ratio	Connectable indoor unit ratio	%	50-160	50-160	50-160	50-160	50-160	50-160	50-160	50-160	50-160	50-160	50-160		
	Maximum number of indoor units		64	64	64	64	64	64	64	64	64	64			
Working temp.	Cooling	°C	(-5-50)												
	Heating	°C	(-23-21)												

Max. total pipe length *1 If the total pipe length to all the indoor units is between 500-1000m, you MUST contact your local distributor/dealer for individual design and separate order.
Standard total pipe length *2 Standard design and production in the factory.
Max drop between I.U.&O.U. *3 If the height difference between the outdoor and the indoor units is from 50 to 110m, you MUST contact your local distributor/dealer for individual design and production.

Standard drop between I.U.&O.U. *4 Standard design and production in the factory.
Max drop between I.U. *5 If the height difference between the indoor units is from 18 to 30m, you MUST contact your local distributor/dealer for individual design and production.
Standard drop between I.U. *6 Standard design and production in the factory.

* All the specifications are tested under nominal condition (in cooling, indoor temp. is 27 °C DB/19 °C WB; Outdoor temp 35 °C DB/24WB; in heating, indoor temp. is 20 °C DB; in heating, outdoor temp. is 7 °C DB/6 °C WB)

T3 380-3-50/60



8/10/12/14HP



16/18/20HP



- Single Module: 8/10/12/14HP, 16/18/20HP
- Combination Module: 22-60HP, 2-3 modules
- Full DC INVERTER technology
- Max. 1000m total pipe length, Max. 110m height drop
- Compatible with all the MRV indoor units.



Model		AV08IMMEUB	AV10IMMEUB	AV12IMMEUB	AV14IMMEUB	AV16IMMEUB	AV18IMMEUB		AV20IMMEUB	AV22IMMEUB	AV24IMMEUB	AV26IMMEUB	AV28IMMEUB	AV30IMMEUB	AV32IMMEUB	AV34IMMEUB	
Combination model		/	/	/	/	/	/		/	AV10IMMEUB	AV10IMMEUB	AV12IMMEUB	AV14IMMEUB	AV14IMMEUB	AV14IMMEUB	AV16IMMEUB	
		/	/	/	/	/	/		/	AV12IMMEUB	AV14IMMEUB	AV14IMMEUB	AV14IMMEUB	AV16IMMEUB	AV18IMMEUB	AV18IMMEUB	
Capacity	Capacity range	HP	8	10	12	14	16	18	20	22	24	26	28	30	32	34	
	Cooling (T1)	kW	25.2	28	33.5	40	45	50.4	56	61.5	68	73.5	80	85	90.4	95.4	
	Cooling (T3)	kW	23.2	25.2	28.5	32.8	39.6	42.8	44.8	53.7	58.0	61.3	65.6	72.4	75.6	82.4	
	Heating	kW	27	33.5	37.8	45	50	58.5	63	71.3	78.5	82.8	90	95	103.5	108.5	
Electrical parameters	Power supply	Ph/V/Hz	3/380-400/50/60	3/380-400/50/60	3/380-400/50/60	3/380-400/50/60	3/380-400/50/60	3/380-400/50/60	3/380-400/50/60	3/380-400/50/60	3/380-400/50/60	3/380-400/50/60	3/380-400/50/60	3/380-400/50/60	3/380-400/50/60	3/380-400/50/60	
	Cooling (T1)	Rated power input	kW	6.00	7.28	8.52	10.22	11.66	13.25	15.20	15.80	17.50	18.74	20.44	21.88	23.47	24.91
		Rated current	A	10.13	12.29	14.38	17.25	19.68	22.37	25.66	26.67	29.54	31.64	34.51	36.94	39.62	42.05
	Cooling (T3)	Rated power input	kW	7.02	8.66	9.76	11.45	13.26	15.25	16.96	18.42	20.11	21.21	22.90	24.71	26.70	28.51
		Rated current	A	11.85	14.62	16.48	19.33	22.39	25.75	28.63	31.10	33.95	35.81	38.66	41.72	45.08	48.13
	Cooling	Max power input	kW	16.91	17.65	22.68	24.36	32.30	35.24	37.47	40.33	42.01	47.04	48.72	56.66	59.60	67.54
		Max current	A	25.10	28.40	32.37	36.80	54.53	56.60	60.50	60.77	65.20	69.17	73.60	93.33	93.40	111.13
	Heating	Rated power input	kW	5.85	7.32	8.70	10.57	11.95	14.05	15.40	16.02	17.89	19.27	21.14	22.52	24.62	26.00
		Max power input	kW	11.90	15.60	17.20	19.7	23.80	25.20	28.62	32.80	35.30	36.90	39.40	43.50	44.90	49.00
		Rated current	A	9.88	12.36	14.69	17.84	20.17	23.72	26.00	27.05	30.20	32.53	35.69	38.02	41.56	43.89
		Max current	A	19.00	25.20	27.90	33.26	38.00	42.30	47.40	53.10	58.46	61.16	66.52	71.26	75.56	80.30
	EER		4.20	3.85	3.93	3.91	3.86	3.80	3.68	3.89	3.89	3.92	3.91	3.88	3.85	3.83	
COP		4.62	4.58	4.34	4.26	4.18	4.16	4.09	4.45	4.39	4.30	4.26	4.22	4.20	4.17		
Performance	Air flow (H)	m ³ /h	C:15000/H:13200	C:15000/H:13200	C:15000/H:13200	C:15600/H:14400	C:16200/H:15000	C:16200/H:15000	C:16200/H:15000	(C:15000/H:13200)*2	(C:15000/H:13200)*2	(C:15600/H:14400)*2	(C:15000/H:13200)+ (C:15600/H:14400)	(C:15600/H:14400)*2	(C:16200/H:15000)+ (C:15600/H:14400)	(C:16200/H:15000)*2	
	Sound pressure level (H)	dB(A)	57	57	57	58	59	60	61	60	60.5	60.5	61	61.5	62	62.5	
	Sound power level (H)	dB(A)	73	73	73	74	76	77	78	77	78	78	78	79	79	80	
Installation	External dimensions (W/D/H)	mm	1350*720*1690	1350*720*1690	1350*720*1690	1350*720*1690	1350*720*2048	1350*720*2048	1350*720*2048	(1350*720*1690)*2	(1350*720*1690)*2	(1350*720*1690)*2	(1350*720*1690)*2	1350*720*1690 +1350*720*2048	1350*720*1690 +1350*720*2048	1350*720*1690 +1350*720*2048	
	Shipping dimensions (W/D/H)	mm	1450*826*1885	1450*826*1885	1450*826*1885	1450*826*1885	1450*826*2225	1450*826*2225	1450*826*2225	(1450*826*1885)*2	(1450*826*1885)*2	(1450*826*1885)*2	(1450*826*1885)*2	1450*826*1885 +1450*826*2225	1450*826*1885 +1450*826*2225	1450*826*1885 +1450*826*2225	
	Net/Shipping weight	kg	276/301	276/301	279/304	321/346	359/384	359/384	359/384	279/304*2	276/301+321/346	321/346+279/304	321/346*2	321/346+359/384	321/346+359/384	359/384*2	
	Compressor type		DC INV. SCROLL	DC INV. SCROLL	DC INV. SCROLL	DC INV. SCROLL	DC INV. SCROLL	DC INV. SCROLL	DC INV. SCROLL	DC INV. SCROLL	DC INV. SCROLL	DC INV. SCROLL	DC INV. SCROLL	DC INV. SCROLL	DC INV. SCROLL	DC INV. SCROLL	
	Compressor brand		DAIKIN	DAIKIN	DAIKIN	DAIKIN	DAIKIN	DAIKIN	DAIKIN	DAIKIN	DAIKIN	DAIKIN	DAIKIN	DAIKIN	DAIKIN	DAIKIN	
	Compressor quantity		1INV	1INV	1INV	2INV	2INV	2INV	2INV	2INV	1INV+1INV	1INV+2INV	1INV+2INV	2INV*2	2INV*2	2INV*2	
	Refrigerant type		R410A	R410A	R410A	R410A	R410A	R410A	R410A	R410A	R410A	R410A	R410A	R410A	R410A	R410A	
	Refrigerant charge	kg	9.7	9.7	10	10	10	10	10	9.7+9.7	9.7+10	10+10	10+10	10+10	10+10	10+10	
	Refrigerant liquid pipe	mm	12.7	12.7	12.7	12.7	12.7	12.7	12.7	19.05	19.05	19.05	19.05	19.05	19.05	19.05	
	Refrigerant gas pipe	mm	25.4	25.4	25.4	28.58	28.58	28.58	28.58	31.8	31.8	31.8	31.8	38.1	38.1	38.1	
	Oil equalization pipe	mm	9.52	9.52	9.52	9.52	9.52	9.52	9.52	9.52	9.52	9.52	9.52	9.52	9.52	9.52	
	Max. total pipe length *1	m	1000	1000	1000	1000	1000	1000	1000	1000	1000	1000	1000	1000	1000	1000	
	Standard total pipe length *2	m	500	500	500	500	500	500	500	500	500	500	500	500	500	500	
	Max. pipe length (Equivalent/Actual)	m	190/165	190/165	190/165	190/165	190/165	190/165	190/165	190/165	190/165	190/165	190/165	190/165	190/165	190/165	
	Max drop between I.U. & O.U. (O.U. up/down) *3	m	110/90	110/90	110/90	110/90	110/90	110/90	110/90	110/90	110/90	110/90	110/90	110/90	110/90	110/90	
	Standard drop between I.U. & O.U. (O.U. up/down) *4	m	50/40	50/40	50/40	50/40	50/40	50/40	50/40	50/40	50/40	50/40	50/40	50/40	50/40	50/40	
Max drop between I.U. *5	m	30	30	30	30	30	30	30	30	30	30	30	30	30	30		
Standard drop between I.U. *6	m	18	18	18	18	18	18	18	18	18	18	18	18	18	18		
External static pressure	Pa	82	82	82	82	82	82	82	82	82	82	82	82	82	82		
Connectable indoor unit ratio	%	50-130	50-130	50-130	50-130	50-130	50-130	50-130	50-130	50-130	50-130	50-130	50-130	50-130	50-130		
Maximum number of indoor units		13	16	20	24	27	30	33	36	40	43	46	50	53	57		
Working temp.	Cooling	C	(-5-52)							(-5-52)			(-5-52)				
	Heating	C	(-23-21)							(-23-21)			(-23-18)				

Max. total pipe length *1
Standard total pipe length *2
Max drop between I.U. & O.U. *3

If the total pipe length to all the indoor units is between 500-1000m, you MUST contact your local distributor/dealer for individual design and separate order.
Standard design and production in the factory.
If the height difference between the outdoor and the indoor units is from 50 to 110m, you MUST contact your local distributor/dealer for individual design and production.

Standard drop between I.U. & O.U. *4
Max drop between I.U. *5
Standard drop between I.U. *6

Standard design and production in the factory.
If the height difference between the indoor units is from 18 to 30m, you MUST contact your local distributor/dealer for individual design and production.
Standard design and production in the factory.

** All the specifications are tested under nominal condition (in cooling T1, indoor temp. is 27 C DB/19 C WB; Outdoor temp 35 C DB/24WB; in cooling T3, indoor temp. is 27 C DB/19 C WB; Outdoor temp 46 C DB/24WB; in heating, indoor temp. is 20 C DB; in heating, outdoor temp. is 7 C DB/6 C WB)

T3 380-3-50/60



60HP



- Single Module: 8/10/12/14HP,16/18/20HP
- Combination Module: 22-60HP, 2-3 modules
- Full DC INVERTER technology
- Max.1000m total pipe length, Max.110m height drop
- Compatible with all the MRV indoor units.



Model	AV36IMMEUB	AV38IMMEUB	AV40IMMEUB	AV42IMMEUB	AV44IMMEUB	AV46IMMEUB	AV48IMMEUB	AV50IMMEUB	AV52IMMEUB	AV54IMMEUB	AV56IMMEUB	AV58IMMEUB	AV60IMMEUB			
Combination model	AV18IMMEUB	AV18IMMEUB	AV20IMMEUB	AV14IMMEUB	AV14IMMEUB	AV14IMMEUB	AV14IMMEUB	AV14IMMEUB	AV16IMMEUB	AV18IMMEUB	AV18IMMEUB	AV18IMMEUB	AV20IMMEUB			
	AV18IMMEUB	AV20IMMEUB	AV20IMMEUB	AV14IMMEUB	AV14IMMEUB	AV18IMMEUB	AV18IMMEUB	AV18IMMEUB	AV18IMMEUB	AV18IMMEUB	AV20IMMEUB	AV20IMMEUB	AV20IMMEUB			
Capacity	Capacity range	HP	36	38	40	42	44	48	50	52	54	56	58	60		
	Cooling (T1)	kW	100.8	106.4	112	120	125	130.4	135.4	140.8	145.8	151.2	156.8	162.4	168	
	Cooling (T3)	kW	85.6	87.6	112	98.4	105.2	108.4	115.2	118.4	125.2	128.4	130.4	132.4	134.4	
	Heating	kW	117	121.5	126	135	140	148.5	153.5	162	167	175.5	180	184.5	189	
Electrical parameters	Power supply	PhV/Hz	3/380-400/50/60	3/380-400/50/60	3/380-400/50/60	3/380-400/50/60	3/380-400/50/60	3/380-400/50/60	3/380-400/50/60	3/380-400/50/60	3/380-400/50/60	3/380-400/50/60	3/380-400/50/60	3/380-400/50/60		
	Cooling (T1)	Rated power input	kW	26.50	28.45	30.40	30.66	32.10	33.30	35.13	36.72	38.16	39.75	41.70	43.65	45.60
		Rated current	A	44.74	48.03	51.32	51.76	55.20	56.22	59.31	61.99	64.42	67.11	70.40	73.69	76.98
	Cooling (T3)	Rated power input	kW	30.50	32.21	33.92	34.35	37.07	38.53	39.96	41.95	43.76	45.75	47.46	49.17	50.88
		Rated current	A	51.49	54.38	57.26	57.99	62.58	65.05	67.46	70.82	73.88	77.24	80.12	83.01	85.90
	Cooling	Max power input	kW	70.48	72.71	74.94	73.08	79.48	82.34	91.90	94.84	102.78	105.72	107.95	110.18	112.41
		Max current	A	113.20	117.10	121.00	110.40	125.70	125.97	147.93	150.00	167.73	173.70	177.60	181.50	
	Heating	Rated power input	kW	28.10	29.45	30.80	31.71	33.29	33.91	36.57	38.67	40.05	42.15	43.50	44.85	46.20
		Max power input	kW	50.40	53.82	57.24	59.10	63.92	68.10	68.70	70.10	74.20	75.60	79.02	82.44	85.86
		Rated current	A	47.44	49.72	52.00	53.53	56.20	57.25	61.74	65.28	67.61	71.16	73.44	75.72	78.00
		Max current	A	84.60	89.70	94.80	99.77	105.86	111.56	113.56	117.86	122.60	126.90	132.00	137.10	142.20
	EER			3.80	3.74	3.68	3.91	3.89	3.92	3.85	3.83	3.82	3.80	3.76	3.72	3.68
COP			4.16	4.13	4.09	4.26	4.21	4.38	4.20	4.19	4.17	4.16	4.14	4.11	4.09	
Performance	Air flow (H)	m³/h	(C:16200/H:15000)*2	(C:16200/H:15000)*2	(C:16200/H:15000)*2	(C:15600/H:14400)*3	(C:15600/H:14400)*2 +(C:16200/H:15000)	(C:15600/H:14400)*2 +(C:16200/H:15000)	(C:15600/H:14400) +(C:16200/H:15000)*2	(C:15600/H:14400) +(C:16200/H:15000)*2	(C:16200/H:15000)*3	(C:16200/H:15000)*3	(C:16200/H:15000)*3	(C:16200/H:15000)*3	(C:16200/H:15000)*3	
	Sound pressure level (H)	dB(A)	63	63.5	65	63	63	63.5	64	64	64.5	65	65	65.5	66	
	Sound power level (H)	dB(A)	80	81	83	81	81	82	82	82	83	83	83	84	84	
Installation	External dimensions (W/D/H)	mm	(1350*720*2048)*2	(1350*720*2048)*2	(1350*720*2048)*2	1350*720*2048 +(1350*720*1690)*3	1350*720*2048 +(1350*720*1690)*2	1350*720*2048 +(1350*720*1690)*2	(1350*720*2048)*2 +1350*720*1690	(1350*720*2048)*2 +1350*720*1690	(1350*720*2048)*3	(1350*720*2048)*3	(1350*720*2048)*3	(1350*720*2048)*3	(1350*720*2048)*3	
	Shipping dimensions (W/D/H)	mm	(1450*826*2225)*2	(1450*826*2225)*2	(1450*826*2225)*2	(1450*826*1885)*3	1450*826*2225 +(1450*826*1885)*2	1450*826*2225 +(1450*826*1885)*2	1450*826*1885 +(1450*826*2225)*2	1450*826*1885 +(1450*826*2225)*2	(1450*826*2225)*3	(1450*826*2225)*3	(1450*826*2225)*3	(1450*826*2225)*3	(1450*826*2225)*3	
	Net/Shipping weight	kg	359/384*2	359/384*2	359/384*2	321/346*3	321/346*2+359/384	321/346*2+359/384	321/346*2+359/384	321/346*2+359/384*2	321/346*2+359/384*2	359/384*3	359/384*3	359/384*3	359/384*3	
	Compressor type		DC INV. SCROLL	DC INV. SCROLL	DC INV. SCROLL	DC INV. SCROLL	DC INV. SCROLL	DC INV. SCROLL	DC INV. SCROLL	DC INV. SCROLL	DC INV. SCROLL	DC INV. SCROLL	DC INV. SCROLL	DC INV. SCROLL	DC INV. SCROLL	
	Compressor brand		MITSUBISHI ELECTRIC	MITSUBISHI ELECTRIC	MITSUBISHI ELECTRIC	MITSUBISHI ELECTRIC	MITSUBISHI ELECTRIC	MITSUBISHI ELECTRIC	MITSUBISHI ELECTRIC	MITSUBISHI ELECTRIC	MITSUBISHI ELECTRIC	MITSUBISHI ELECTRIC	MITSUBISHI ELECTRIC	MITSUBISHI ELECTRIC	MITSUBISHI ELECTRIC	
	Compressor quantity		2INV*2	2INV*2	2INV*2	2INV*3	2INV*3	2INV*3	2INV*3	2INV*3	2INV*3	2INV*3	2INV*3	2INV*3	2INV*3	
	Refrigerant type		R410A	R410A	R410A	R410A	R410A	R410A	R410A	R410A	R410A	R410A	R410A	R410A	R410A	
	Refrigerant charge	kg	10+10	10+10	10+10	10+10+10	10+10+10	10+10+10	10+10+10	10+10+10	10+10+10	10+10+10	10+10+10	10+10+10	10+10+10	
	Refrigerant liquid pipe	mm	19.05	19.05	19.05	19.05	19.05	19.05	19.05	19.05	19.05	19.05	19.05	22.22	22.22	
	Refrigerant gas pipe	mm	38.1	38.1	38.1	38.1	38.1	38.1	41.3	41.3	41.3	41.3	44.5	44.5	44.5	
Oil equalization pipe	mm	9.52	9.52	9.52	9.52	9.52	9.52	9.52	9.52	9.52	9.52	9.52	9.52	9.52		
Max.total pipe length *1	m	1000	1000	1000	1000	1000	1000	1000	1000	1000	1000	1000	1000	1000		
Standard total pipe length *2	m	500	500	500	500	500	500	500	500	500	500	500	500	500		
Max. pipe length (Equivalent/Actual)	m	190/165	190/165	190/165	190/165	190/165	190/165	190/165	190/165	190/165	190/165	190/165	190/165	190/165		
Max drop between I.U.&O.U (O.U up/down) *3	m	110/90	110/90	110/90	110/90	110/90	110/90	110/90	110/90	110/90	110/90	110/90	110/90	110/90		
Standard drop between I.U. &O.U (O.U up/down) *4	m	50/40	50/40	50/40	50/40	50/40	50/40	50/40	50/40	50/40	50/40	50/40	50/40	50/40		
Max drop between I.U *5	m	30	30	30	30	30	30	30	30	30	30	30	30	30		
Standard drop between I.U *6	m	18	18	18	18	18	18	18	18	18	18	18	18	18		
External static pressure	Pa	82	82	82	82	82	82	82	82	82	82	82	82	82		
Connection ratio	Connectable indoor unit ratio	%	50-130	50-130	50-130	50-130	50-130	50-130	50-130	50-130	50-130	50-130	50-130	50-130		
	Maximum number of indoor units		60	64	64	64	64	64	64	64	64	64	64	64		
Working temp.	Cooling	C														
	Heating	C														

Max.total pipe length *1
Standard total pipe length *2
Max drop between I.U.&O.U *3
If the total pipe length to all the indoor units is between 500-1000m, you MUST contact your local distributor/dealer for individual design and separate order.
Standard design and production in the factory.
If the height difference between the outdoor and the indoor units is from 50 to 110m, you MUST contact your local distributor/dealer for individual design and production.

Standard drop between I.U.&O.U *4
Max drop between I.U. *5
Standard drop between I.U. *6
Standard design and production in the factory.
If the height difference between the indoor units is from 18 to 30m, you MUST contact your local distributor/dealer for individual design and production.
Standard design and production in the factory.

** All the specifications are tested under nominal condition (in cooling T1, indoor temp. is 27 C DB/19 C WB, Outdoor temp 35 C DB/24WB; in cooling T3, indoor temp. is 27 C DB/19 C WB, Outdoor temp 46 C DB/24WB; in heating, indoor temp. is 20 C DB, in heating, outdoor temp. is 7 C DB/6 C WB)



MRV III-C

| 033 Features & Benefits
| 041 Outdoor Specification



FEATURES & BENEFITS

MRV III-C

Air Supply Chamber and Equipment Chamber Separation Design

1. Prevent electrical parts and the main functional components by the rain Erosion, prolong the service life of components;
2. Compressor running noise was closed in the equipment room, reduce the running noise about 3 dB(A);
3. Air supply chamber complete isolation: During commissioning and maintenance, the units can be used normally.

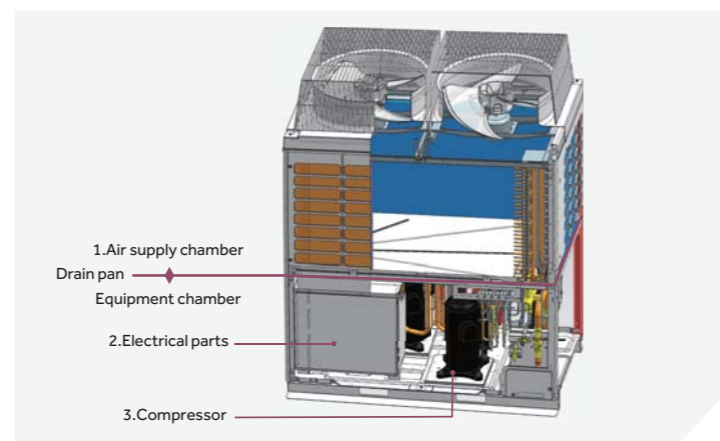

Special Heat Exchanger Design

4 way air return heat exchanger design

Reduce the heat exchanger height (650mm), and the upper and lower wind speed uniform and high efficiency.



The two stage heat exchanger are respectively controlled by a electronic expansion valve control, which can adjust the condenser volume.

Two stages heat exchanger design

Two stages heat exchanger can separate control and adjust heat exchanger size, effectively cope with small load operation, to ensure the reliable operation range.



Special Heat Exchanger Design

- Aviation noise reduction patent fan design
 - Streamline vortex fan, sharp fan blade edge, and a certain degree of curvature, reduce the vibration, and pressure loss.
- DC fan motor
 - DC inverter technology •High efficiency •Low noise



Electric Control Box Heat Dissipation Design

Streamline vortex fan forced heat dissipation fan inside the electric control box, to ensure the stable internal temperature and stable system operationn, sharp fan blade edge, and a certain degree of curvature, reduce the vibration, and pressure loss.

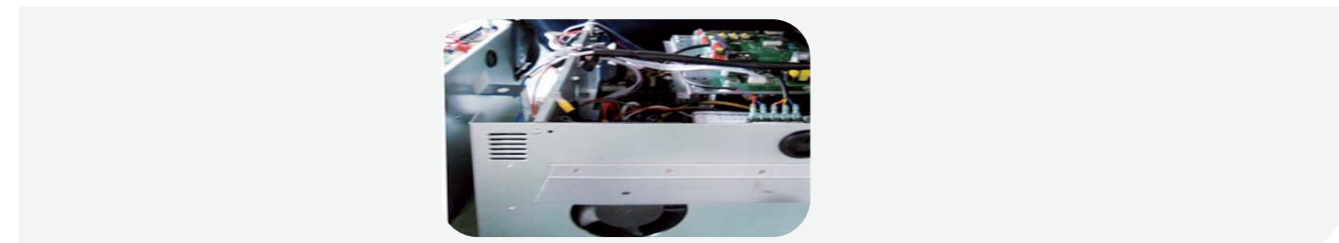

Energy Efficient

High Efficiency DC Inverter Scroll Compressor

- DC inverter scroll compressor imported from mitsubishi electric.
- Equipped with a "Frame Compliance Mechanism" that allows movement in the axial direction of the frame supporting the cradle scroll. This greatly reduces both leakage and friction loss, ensuring very high efficiency throughout the whole speed range.

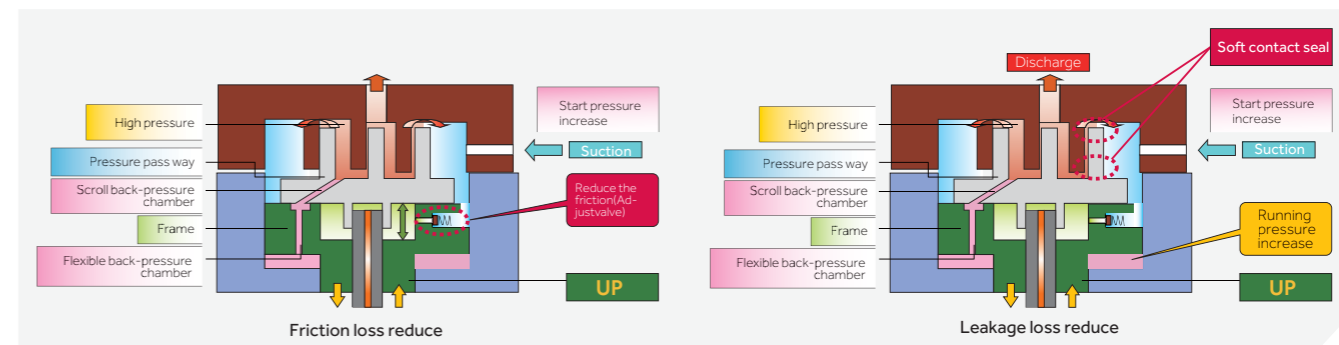

FEATURES & BENEFITS

Energy Efficient

64 Stage Speed Adjustment DC Fan Motor

Efficiency increase 45% comparing with AC motor and power input largely decrease. 64 stage speed adjustment plus DC inverter drive, stabilizing compressor discharge pressure and suction pressure to ensure high system reliability.

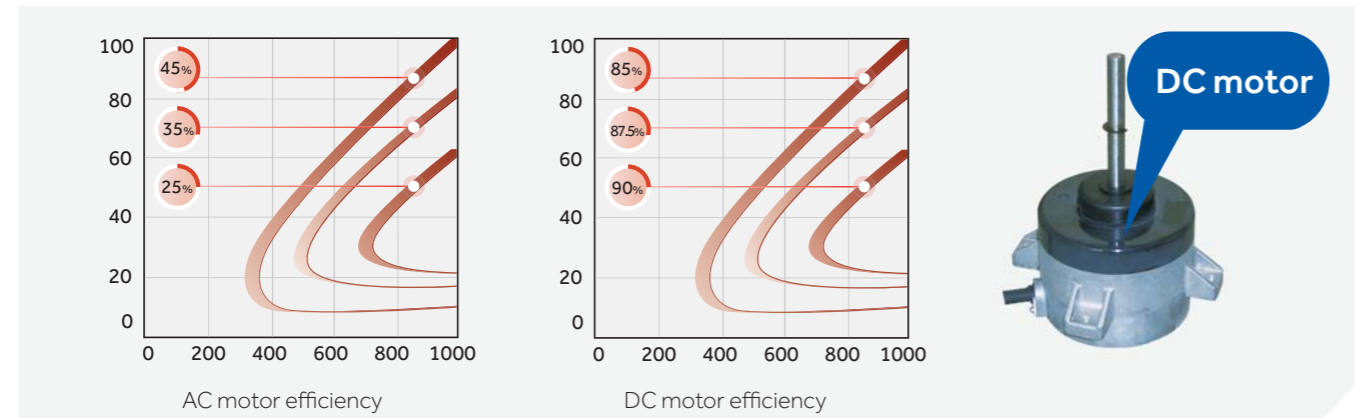

Stepless DC Inverter Control Technology

High precision control, variable frequency drive from 0 to 360Hz.

180° vector DC inverter drive technology: Sine wave current drive, efficiency improve 17% comparing to conventional rectangle wave.

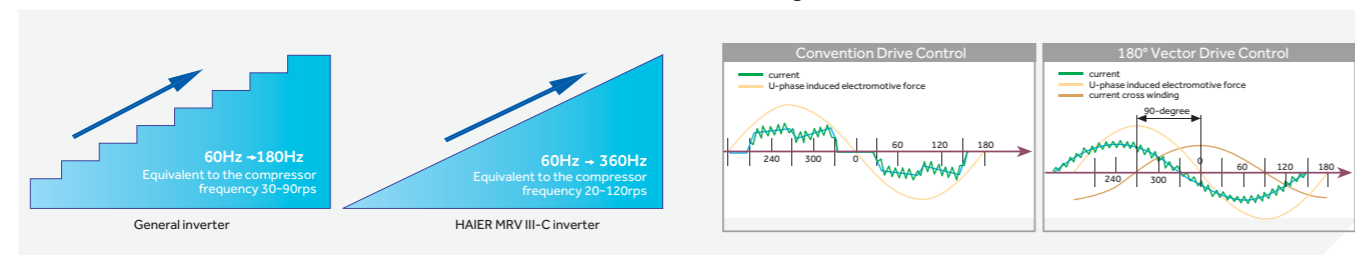

Two Stage Deep Sub Cooling Technology

1st stage sub cooling added a sub cooling coil to condenser.
2nd stage sub cooling added a stand alone sub cooler.
After further cooling, sub-cooling degree can be up to 30°C, with the heat exchanging capacity per unit mass of xrefrigerant improved by 46% and flow resistance reduced by 55%, and running efficiency improved by 9%.

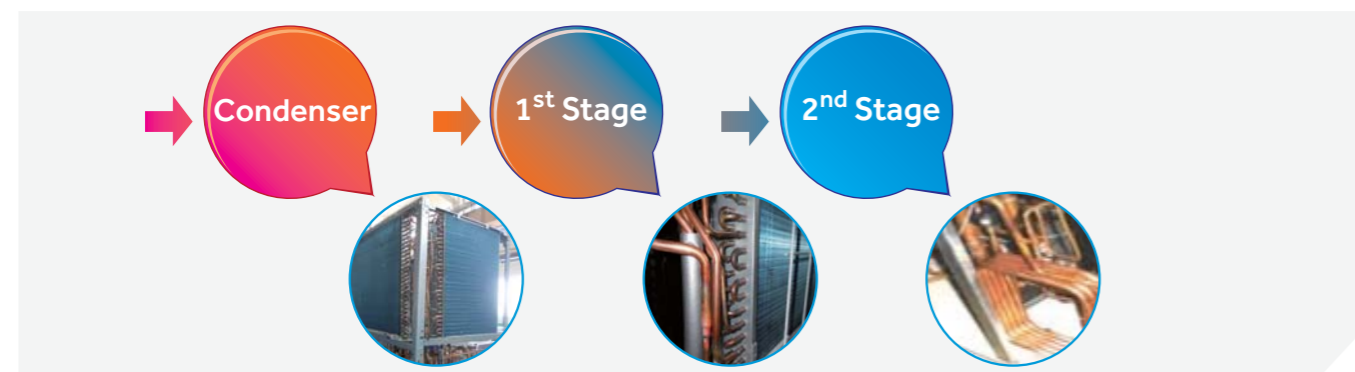

Energy Management Technology

There is energy saving dip switch (SW8-3) in the indoor unit which can be lock the temperature at 26°C in summer and 20°C in winter, to avoid the energy waste and realize the centralized management. The temperature lock function also can be realized through the new wired controller YR-E16.



High Efficiency Heat Exchanging Technology

Outdoor high efficiency four way air return heat exchanger design. The compressor and condenser are placed in separated chamber. High efficiency heat exchanger design. Efficient $\phi 8$ inner grooved tube and 0.11 hydrophilic aluminum coil fin, corrosion and oxidation resistance treatment.

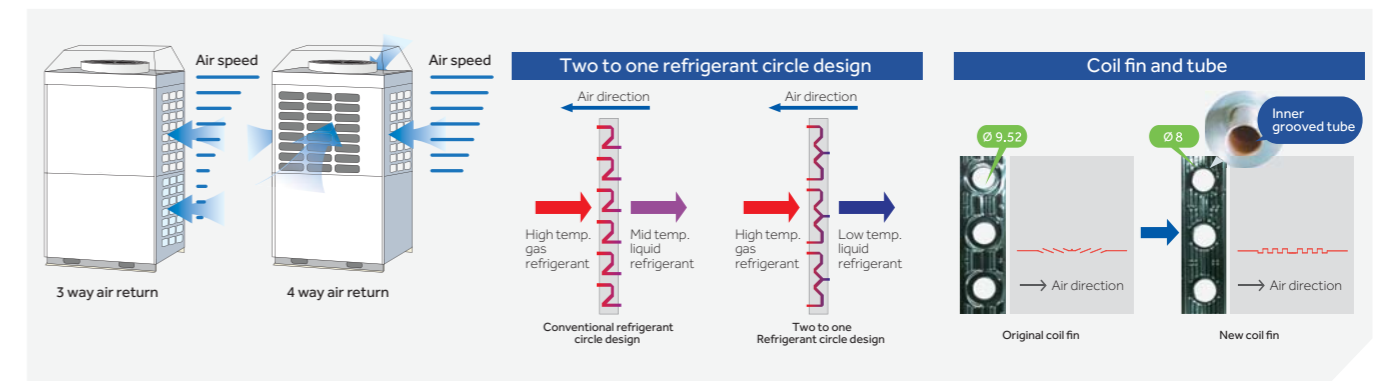

Comfort

Precise Control

Adopt the inverter control, the temperature could be control precisely within the range of $\pm 0.5^\circ\text{C}$.

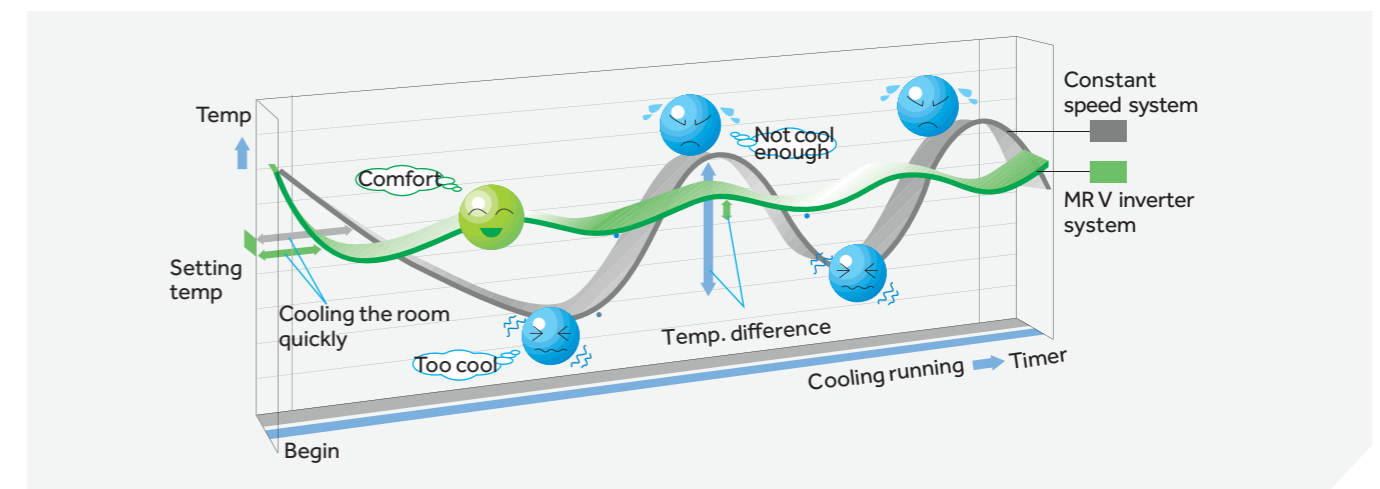

FEATURES & BENEFITS

Comfort

Low Noise and Night Silent Running

Machinery chamber is separated from air supply chamber; Built-in high efficient muffler in the machinery chamber greatly reduce the compressor noise. The night silent running function can be set on the outdoor PCB. The noise can be reduced by 8 dB(A) at most.

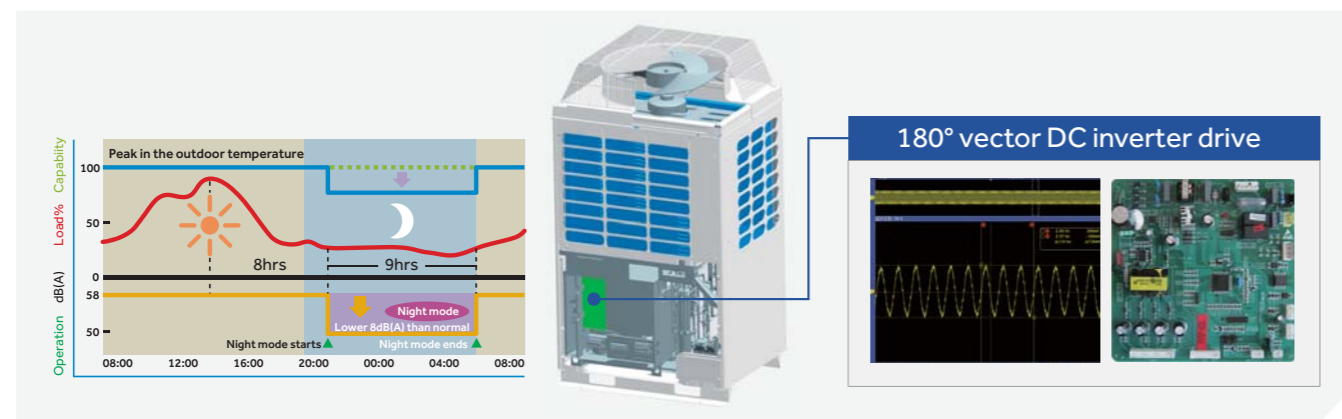

Double EEV Control

Make sure the refrigerant flow equally, to provide more comfort temperature.

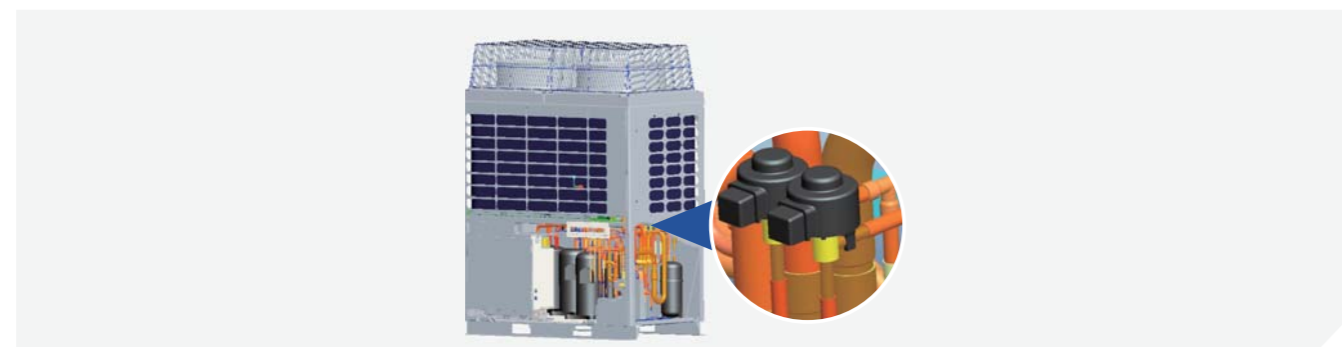

Priority Setting

With the human design, you can set different preferential steps of some indoor units according to the room functions, so that it will ensure that the most important room gains high priority.

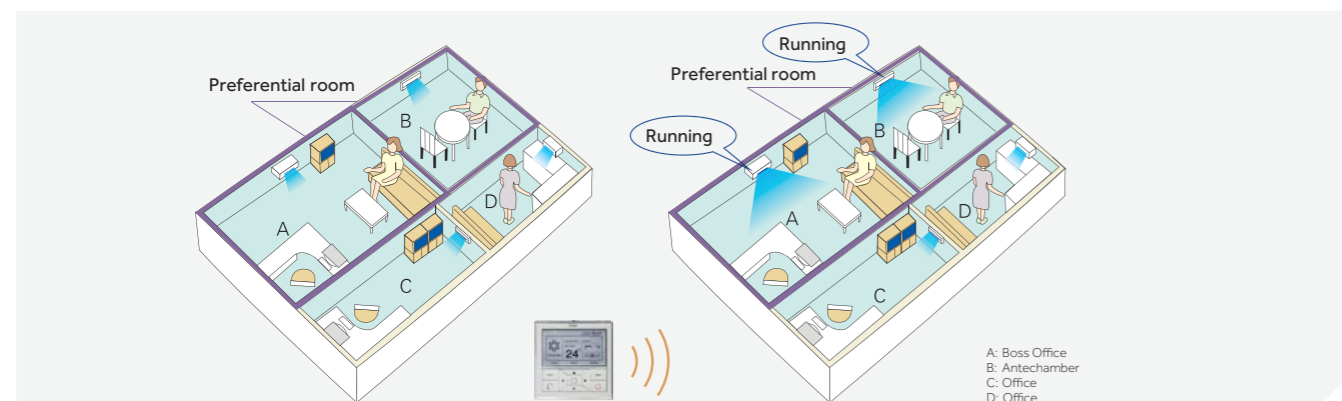

Convenient Installation

Easy Transportation

Outdoor footprint only occupy 0.74m²(8/10HP) and 1.04m² (12/14/16HP). Can lift with elevators and save lots of transport cost and time.

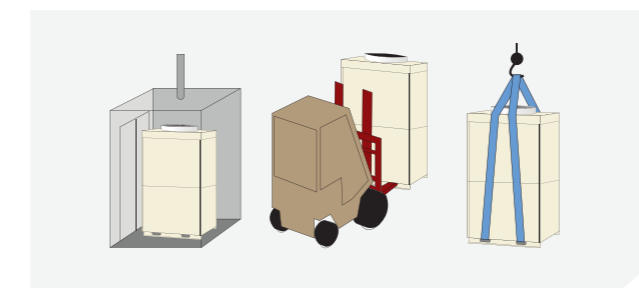

Outdoor High External Static Pressure

Up to 50Pa and can be installed at different floors.



Connection Wire

Two core nonpolar communication line way, no joint wrong hidden trouble. Centralized controller bus and indoor/outdoor bus shareable, wiring and access is very simple Indoor address automatically set.

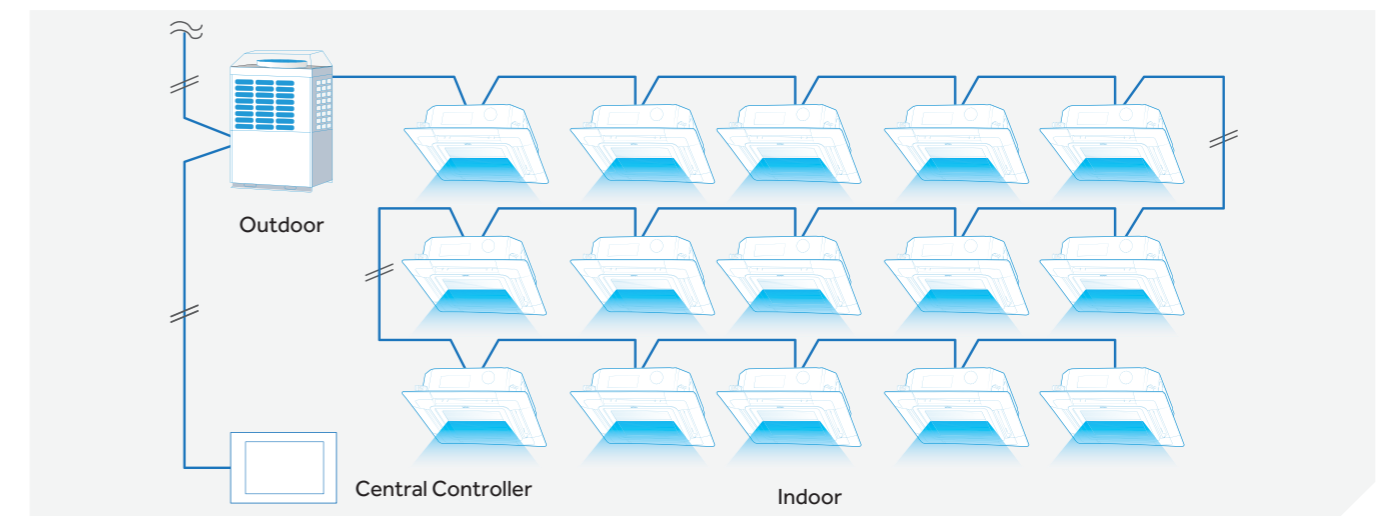

FEATURES & BENEFITS

High Reliability

The First 2-stages Oil Separation and Cross Oil Return Technology in The Industry

1st stage oil separation: built-in oil separating unit, greatly reduced the oil from the compressor discharge.
 2nd stage oil separation: external oil separator to separate the small amount oil from discharge.

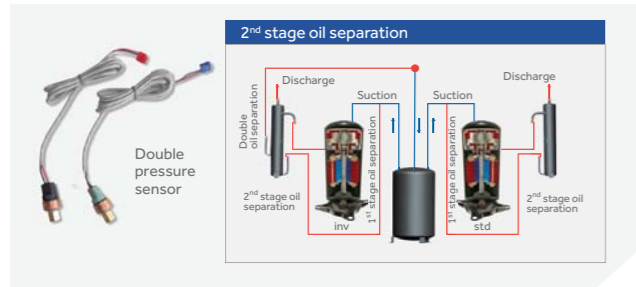

High Pressure Difference Oil Equalization

Using the pressure difference between suction and discharge, to realize fast oil balance between module.

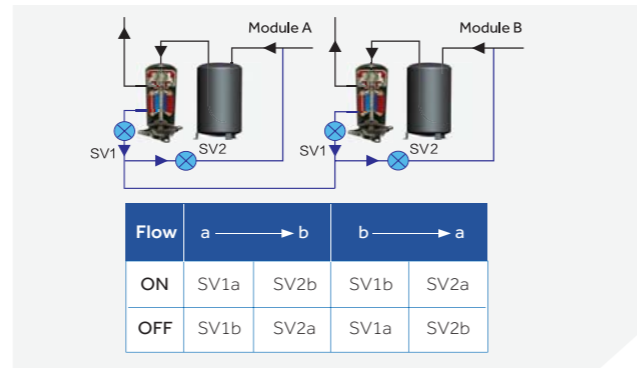

Compressor Anti-liquid Shock Technology

Compressor adopt flexible frame mechanism, when any liquid enter into compressor, cradle scroll detaching fixed scroll, discharging liquid refrigerant out of scroll set, to avoid scroll damage.

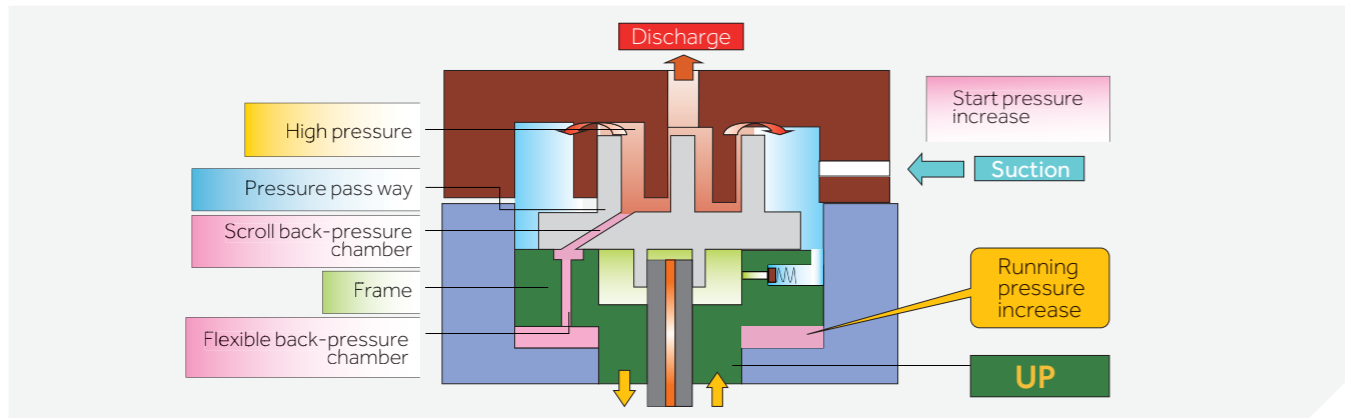

Duty Cycle Operation to Extend the System Lifetime (Combination Model)

The outdoor units priority operating changes every 24 hours. Outdoor units start in turn and operation time can be balanced. Inverter compressor lifetime can be extend maximum 3 times.



High Reliability

Field Test

The system has been running for over 3 years at the jobsite where the vertical height approximately to 100m.

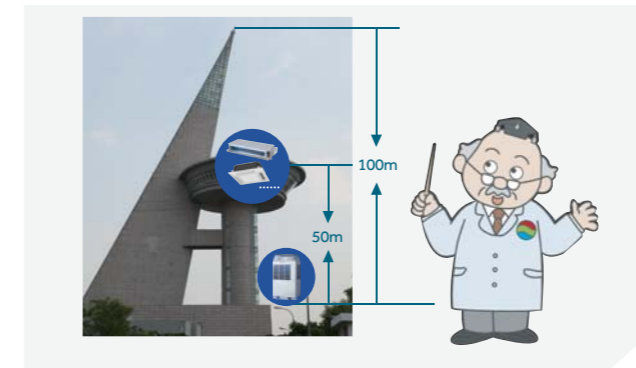

Supporting Tools

MRV design express

This software supply a solution of piping & wiring design, can help the designer select the right material lists, basic wiring diagram and control wiring diagram etc., most important thing is to save lots of time during design procedure.

On-site service software

Features: Save the installation and maintenance people time. More precise than normal checking method.

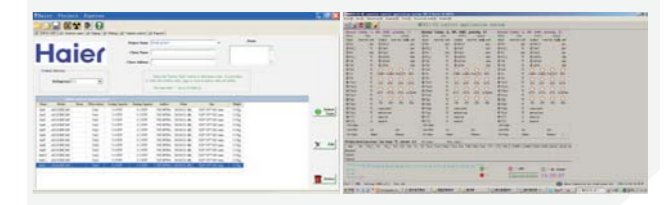

Backup Operation

If one outdoor unit get into malfunction, the other units continue to operate without affecting the whole system.

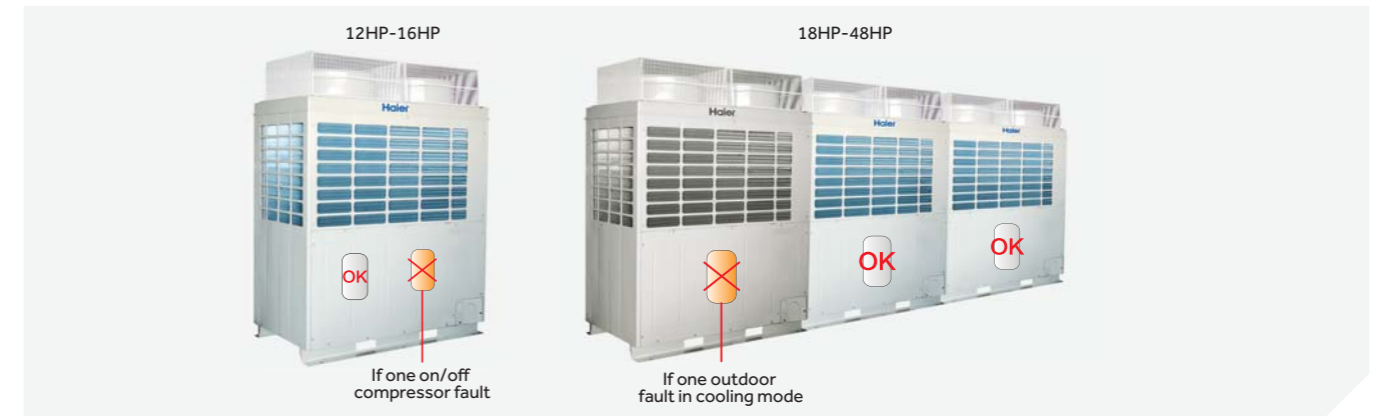

Test Lab.



MRV III-C(T1) 50/60Hz-380~400V-3Ph



8/10HP



12/14/16HP



Dual Frequency 50/60Hz-380~400V-3Ph
 DC Inverter Scroll Compressor & BLDC Fan
 Basic Modular Units: 8HP, 10HP, 12HP, 14HP, 16HP
 Free Combination up to 48HP with Incremental 2HP
 Max. Indoor Units up to 64



Model		AV08NMVESA	AV10NMVESA	AV12IMVESA	AV14IMVESA	AV16IMVESA	AV18IMVESA	AV20IMVESA	AV22IMVESA	AV24IMVESA		AV26IMVESA	AV28IMVESA	AV30IMVESA	AV32IMVESA	AV34IMVESA	AV36IMVESA	AV38IMVESA	AV40IMVESA	AV42IMVESA	AV44IMVESA	AV46IMVESA	AV48IMVESA			
Combination model		/	/	/	/	/	AV08NMVESA	AV10NMVESA	AV10NMVESA	AV10NMVESA		AV10NMVESA	AV14IMVESA	AV14IMVESA	AV16IMVESA	AV10NMVESA	AV10NMVESA	AV10NMVESA	AV10NMVESA	AV10NMVESA	AV12IMVESA	AV14IMVESA	AV16IMVESA			
Capacity		Capacity range	HP	8	10	12	14	16	18	20	22	24		26	28	30	32	34	36	38	40	42	44	46	48	
		Cooling	kW	22.6	28	33.5	40	45	50.6	56	61.5	68		73	80	85	90	96	101	108	113	118	123.5	130	135	
		Heating	kW	25	31.5	37.5	45	50	56.5	63	69	76.5		81.5	90	95	100	108	113	121.5	126.5	131.5	137.5	145	150	
Electrical parameters		Power supply	Ph/V/Hz	3/380-400/50/60	3/380-400/50/60	3/380-400/50/60	3/380-400/50/60	3/380-400/50/60	3/380-400/50/60	3/380-400/50/60	3/380-400/50/60	3/380-400/50/60		3/380-400/50/60	3/380-400/50/60	3/380-400/50/60	3/380-400/50/60	3/380-400/50/60	3/380-400/50/60	3/380-400/50/60	3/380-400/50/60	3/380-400/50/60	3/380-400/50/60	3/380-400/50/60		
		Cooling	Rated power input	kW	5.27	7.36	10	11.4	13.4	14.72	17.36	18.76		20.76	22.8	24.8	26.8	26.12	28.12	30.16	32.16	34.16	36.8	38.2	40.2	
			Max power input	kW	12.37	14.7	17.54	18.55	20.48	27.07	29.4	29.91	33.25		35.18	37.1	39.03	40.96	47.95	49.88	51.8	53.73	55.66	58.5	59.51	61.44
			Rated current	A	8.7	11.1	14.2	19.05	20.3	19.8	22.2	25.3	30.15		31.4	38.1	39.35	40.6	41.25	42.5	49.2	50.45	51.7	54.8	59.65	60.9
		Heating	Max current	A	19.85	23.4	27.9	29.5	32.37	43.25	46.8	47.75	52.9		55.77	59	61.87	64.74	76.3	79.17	82.4	85.27	88.14	92.64	97.11	
			Rated power input	kW	5.89	7.97	10	11.6	13.5	13.86	15.94	17.97	19.57		21.47	23.2	25.1	27	27.54	29.4	31.17	33.07	34.97	37	38.6	40.5
			Max power input	kW	9.77	11.9	14.6	16.6	17.8	21.67	23.8	24.37	28.5		29.7	24.37	28.5	34.4	35.6	40.4	41.6	45.1	46.3	47.5	50.2	52.2
		Rated current	A	9.7	12.5	15.1	17.96	19.3	22.2	25	27.6	30.46		31.8	35.92	37.26	38.6	42.96	44.3	48.42	49.76	51.1	53.7	56.56	57.9	
		Max current	A	15.7	19	23.3	26.5	28.4	34.7	38	39	45.5		47.4	53	54.9	56.8	64.5	66.4	72	73.9	75.8	80.1	83.3	85.2	
		EER		4.29	3.80	3.35	3.51	3.36	4.01	3.80	3.54	3.62		3.52	3.51	3.43	3.36	3.68	3.59	3.58	3.51	3.45	3.36	3.40	3.36	
		COP		4.24	3.95	3.75	3.88	3.70	4.08	3.95	3.84	3.91		3.80	3.88	3.78	3.70	3.92	3.84	3.90	3.83	3.76	3.72	3.76	3.70	
Performance		Air flow (H)	m ³ /h	11000	11000	14100	14100	14100	22200	22200	25200	25200		25200	28200	28200	28200	28200	36300	36300	39300	39300	42300	42300	42300	
		Sound pressure level (H)	dB(A)	57	57	60	60	60	60	60	61	61		61	62	62	62	63	63	63	63	64	64	64	64	
			dB(A)	73	73	76	76	76	77	77	77	78	78		78	79	79	79	81	81	81	81	81	82	82	82
Installation		External dimensions (W/D/H)	mm	990/750/1808	990/750/1808	1390/750/1808	1390/750/1808	1390/750/1808	990/750/1808+990/750/1808	990/750/1808+990/750/1808	990/750/1808+1390/750/1808	990/750/1808+1390/750/1808		990/750/1808+1390/750/1808	1390/750/1808+1390/750/1808	1390/750/1808+1390/750/1808	1390/750/1808+1390/750/1808	990/750/1808+990/750/1808	990/750/1808+1390/750/1808	990/750/1808+1390/750/1808	990/750/1808+1390/750/1808	1390/750/1808+1390/750/1808	1390/750/1808+1390/750/1808	1390/750/1808+1390/750/1808		
		Shipping dimensions (W/D/H)	mm	1090/860/1990	1090/860/1990	1490/860/1990	1490/860/1990	1490/860/1990	1090/860/1990+1090/860/1990	1090/860/1990+1090/860/1990	1090/860/1990+1490/860/1990	1090/860/1990+1490/860/1990		1090/860/1990+1490/860/1990	1490/860/1990+1490/860/1990	1490/860/1990+1490/860/1990	1490/860/1990+1490/860/1990	1090/860/1990+1090/860/1990	1090/860/1990+1490/860/1990	1490/860/1990+1490/860/1990	1490/860/1990+1490/860/1990	1490/860/1990+1490/860/1990	1490/860/1990+1490/860/1990	1490/860/1990+1490/860/1990		
		Net/Shipping weight	kg	240/255	240/255	360/378	360/378	368/386	480/510	480/510	600/633	600/633		608/641	720/756	728/764	736/772	840/888	848/896	960/1011	968/1019	976/1027	1096/1150	1096/1150	1104/1158	
		Compressor type		DC INV SCROLL	DC INV SCROLL	DC INV SCROLL	DC INV SCROLL	DC INV SCROLL	DC INV SCROLL	DC INV SCROLL	DC INV SCROLL	DC INV SCROLL		DC INV SCROLL	DC INV SCROLL	DC INV SCROLL	DC INV SCROLL	DC INV SCROLL	DC INV SCROLL	DC INV SCROLL	DC INV SCROLL	DC INV SCROLL	DC INV SCROLL	DC INV SCROLL		
		Compressor brand		DAIKIN	DAIKIN	DAIKIN	DAIKIN	DAIKIN	DAIKIN	DAIKIN	DAIKIN	DAIKIN		DAIKIN	DAIKIN	DAIKIN	DAIKIN	DAIKIN	DAIKIN	DAIKIN	DAIKIN	DAIKIN	DAIKIN	DAIKIN		
		Compressor quantity		1 INV	1 INV	1 INV+1 FIX	1 INV+1 FIX	1 INV+1 FIX	1 INV+1 INV	1 INV+1 INV	(1 INV)+1 INV	(1 INV)+1 INV		(1 INV)+1 INV	(1 INV)+1 INV	(1 INV)+1 INV	(1 INV)+1 INV	(1 INV)+1 INV	(1 INV)+1 INV	(1 INV)+1 INV	(1 INV)+1 INV	(1 INV)+1 INV	(1 INV)+1 INV	(1 INV)+1 INV		
		Refrigerant type		R410A	R410A	R410A	R410A	R410A	R410A	R410A	R410A	R410A		R410A	R410A	R410A	R410A	R410A	R410A	R410A	R410A	R410A	R410A	R410A		
		Refrigerant charge	kg	10	10	10	10	10	20	20	20	20		20	20	20	20	30	30	30	30	30	30	30		
		Refrigerant liquid pipe	mm	9.52	9.52	12.7	12.7	12.7	15.88	15.88	15.88	15.88		19.05	19.05	19.05	19.05	19.05	19.05	19.05	19.05	19.05	19.05	19.05		
		Refrigerant gas pipe	mm	19.05	22.22	25.4	25.4	28.58	28.58	28.58	28.58	28.58		31.8	31.8	31.8	31.8	31.8	38.1	38.1	38.1	38.1	38.1	38.1		
		Oil equalization pipe	mm	9.52	9.52	9.52	9.52	9.52	9.52	9.52	9.52	9.52		9.52	9.52	9.52	9.52	9.52	9.52	9.52	9.52	9.52	9.52	9.52		
		Total pipe length	m	300	300	300	300	300	300	300	300	300		300	300	300	300	300	300	300	300	300	300	300		
		Max pipe length (Equivalent/Actual)	m	175/150	175/150	175/150	175/150	175/150	175/150	175/150	175/150	175/150		175/150	175/150	175/150	175/150	175/150	175/150	175/150	175/150	175/150	175/150	175/150		
		Max drop between I.U.&O.U	m	50/40	50/40	50/40	50/40	50/40	50/40	50/40	50/40	50/40		50/40	50/40	50/40	50/40	50/40	50/40	50/40	50/40	50/40	50/40	50/40		
		External static pressure	Pa	50	50	50	50	50	50	50	50	50		50	50	50	50	50	50	50	50	50	50	50		
Connection ratio		Connectable indoor unit ratio	%	50-130	50-130	50-130	50-130	50-130	50-130	50-130	50-130	50-130		50-130	50-130	50-130	50-130	50-130	50-130	50-130	50-130	50-130	50-130	50-130		
		Maximum number of indoor units		13	16	19	23	26	29	33	36	39		43	46	50	53	56	59	63	64	64	64	64		
Working temp.		Cooling	°C	-5~43	-5~43	-5~43	-5~43	-5~43	-5~43	-5~43	-5~43	-5~43		-5~43	-5~43	-5~43	-5~43	-5~43	-5~43	-5~43	-5~43	-5~43	-5~43	-5~43		
		Heating	°C	-15~21	-15~21	-15~21	-15~21	-15~21	-15~21	-15~21	-15~21	-15~21		-15~21	-15~21	-15~21	-15~21	-15~21	-15~21	-15~21	-15~21	-15~21	-15~21	-15~21		

* 1 outdoor above 50m outdoor below 40m
 * All the specifications are tested under nominal condition (In cooling, Indoor temp is 27°C DB/19°C WB, Outdoor temp 35°C DB/24°C WB. In heating, Indoor temp is 20°C DB, Outdoor temp is 7°C DB/6°C WB)

MRVIII-C(T1) 60Hz-208~230V-3Ph



8/10HP



12/14/16HP

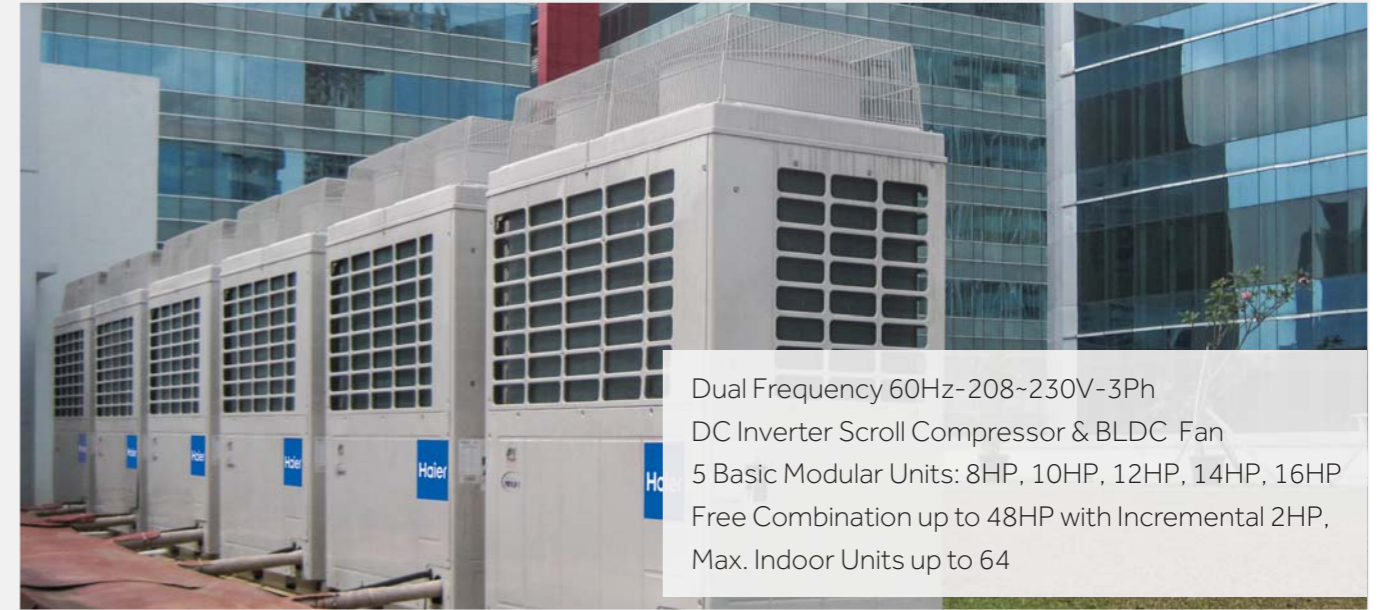

Dual Frequency 60Hz-208~230V-3Ph
 DC Inverter Scroll Compressor & BLDC Fan
 5 Basic Modular Units: 8HP, 10HP, 12HP, 14HP, 16HP
 Free Combination up to 48HP with Incremental 2HP,
 Max. Indoor Units up to 64



Model		AV08CMVESA	AV10CMVESA	AV12CMVESA	AV14CMVESA	AV16CMVESA	AV18CMVESA	AV20CMVESA	AV22CMVESA	AV24CMVESA	AV26CMVESA	AV28CMVESA	AV30CMVESA	AV32CMVESA	AV34CMVESA	AV36CMVESA	AV38CMVESA	AV40CMVESA	AV42CMVESA	AV44CMVESA	AV46CMVESA	AV48CMVESA		
Combination model		/	/	/	/	/	/	/	/	/	/	/	/	/	/	/	/	/	/	/	/	/	/	
Capacity	Capacity range	HP	8	10	12	14	16	18	20	22	24	26	28	30	32	34	36	38	40	42	44	46	48	
	Cooling	kW	22.6	28	33.5	40	45	50.6	56	61.5	68	73	80	85	90	96	101	108	113	118	123.5	130	135	
	Heating	kW	25	31.5	37.5	45	50	56.5	63	69	76.5	81.5	90	95	100	108	113	121.5	126.5	131.5	137.5	145	150	
	Power supply	Ph/V/Hz	3/208-230/60	3/208-230/60	3/208-230/60	3/208-230/60	3/208-230/60	3/208-230/60	3/208-230/60	3/208-230/60	3/208-230/60	3/208-230/60	3/208-230/60	3/208-230/60	3/208-230/60	3/208-230/60	3/208-230/60	3/208-230/60	3/208-230/60	3/208-230/60	3/208-230/60	3/208-230/60	3/208-230/60	
Electrical parameters	Cooling	Rated power input	kW	5.6	8.5	10	12	14	14.1	17	18.5	20.5	22.5	24	26	28	29	31	32.5	34.5	36.5	38	40	42
		Max power input	kW	12.5	14.5	16.5	18.5	20	27	29	31	33	34.5	37	38.5	40	47.5	49	51.5	53	54.5	56.5	58.5	60
		Rated current	A	15.15	23.35	27.55	32.75	38.95	38.5	46.7	50.9	56.1	62.3	65.5	71.7	77.9	79.5	85.7	88.9	95.1	101.3	105.5	110.7	116.9
		Max current	A	38.6	44.7	50.9	57.1	61.7	83.3	89.4	95.6	101.8	106.4	114.2	118.8	123.4	146.5	151.1	158.9	163.5	168.1	174.3	180.5	185.1
	Heating	Rated power input	kW	5.9	8.8	10.3	12.6	14.5	14.7	17.6	19.1	21.4	23.3	25.2	27.1	29	30.2	32.1	34	35.9	37.8	39.3	41.6	43.5
		Max power input	kW	12.5	14.5	16.5	18.5	20	27	29	31	33	34.5	37	38.5	40	47.5	49	51.5	53	54.5	56.5	58.5	60
		Rated current	A	16.05	24.25	28.45	34.65	39.85	40.3	48.5	52.7	58.9	64.1	69.3	74.5	79.7	83.2	88.4	93.6	98.8	104.0	108.2	114.4	119.6
		Max current	A	38.6	44.7	50.9	57.1	61.7	83.3	89.4	95.6	101.8	106.4	114.2	118.8	123.4	146.5	151.1	158.9	163.5	168.1	174.3	180.5	185.1
	EER		4.04	3.29	3.35	3.33	3.21	3.59	3.29	3.32	3.32	3.24	3.33	3.27	3.21	3.31	3.26	3.32	3.28	3.23	3.25	3.25	3.21	
	COP		4.24	3.58	3.64	3.57	3.45	3.84	3.58	3.61	3.57	3.50	3.57	3.51	3.45	3.58	3.52	3.57	3.52	3.48	3.50	3.49	3.45	
Performance	Air flow (H)	m³/h	11100	11100	14100	14100	14100	22200	22200	25200	25200	25200	28200	28200	28200	36300	36300	39300	39300	39300	42300	42300	42300	
	Sound pressure level (H)	dB(A)	57	57	60	60	60	60	61	61	61	61	62	62	62	63	63	63	63	63	64	64	64	
	Sound power level (H)	dB(A)	73	73	76	76	76	77	77	78	78	78	78	79	79	79	81	81	81	81	81	82	82	82
Installation	External dimensions (W/D/H)	mm	990/750/1808	990/750/1808	1390/750/1808	1390/750/1808	1390/750/1808	990/750/1808+990/750/1808	990/750/1808+990/750/1808	990/750/1808+1390/750/1808	990/750/1808+1390/750/1808	990/750/1808+1390/750/1808	1390/750/1808+1390/750/1808	1390/750/1808+1390/750/1808	990/750/1808+1390/750/1808	990/750/1808+1390/750/1808	1390/750/1808+1390/750/1808	1390/750/1808+1390/750/1808	1390/750/1808+1390/750/1808	1390/750/1808+1390/750/1808	1390/750/1808+1390/750/1808	1390/750/1808+1390/750/1808	1390/750/1808+1390/750/1808	
	Shipping dimensions (W/D/H)	mm	1090/860/1990	1090/860/1990	1490/860/1990	1490/860/1990	1490/860/1990	1090/860/1990+1090/860/1990	1090/860/1990+1090/860/1990	1090/860/1990+1490/860/1990	1090/860/1990+1490/860/1990	1090/860/1990+1490/860/1990	1090/860/1990+1490/860/1990	1490/860/1990+1490/860/1990	1490/860/1990+1490/860/1990	1090/860/1990+1490/860/1990	1090/860/1990+1490/860/1990	1490/860/1990+1490/860/1990	1490/860/1990+1490/860/1990	1490/860/1990+1490/860/1990	1490/860/1990+1490/860/1990	1490/860/1990+1490/860/1990	1490/860/1990+1490/860/1990	
	Net/Shipping weight	kg	240/255	240/255	368/386	368/386	368/386	480/510	480/510	608/641	608/641	608/641	608/641	736/772	736/772	848/896	848/896	976/1027	976/1027	976/1027	1104/1158	1104/1158	1104/1158	1104/1158
	Compressor type		DC INV SCROLL	DC INV SCROLL	DC INV SCROLL	DC INV SCROLL	DC INV SCROLL	DC INV SCROLL	DC INV SCROLL	DC INV SCROLL	DC INV SCROLL	DC INV SCROLL	DC INV SCROLL	DC INV SCROLL	DC INV SCROLL	DC INV SCROLL	DC INV SCROLL	DC INV SCROLL	DC INV SCROLL	DC INV SCROLL	DC INV SCROLL	DC INV SCROLL	DC INV SCROLL	DC INV SCROLL
	Compressor brand		DAIKIN	DAIKIN	DAIKIN	DAIKIN	DAIKIN	DAIKIN	DAIKIN	DAIKIN	DAIKIN	DAIKIN	DAIKIN	DAIKIN	DAIKIN	DAIKIN	DAIKIN	DAIKIN	DAIKIN	DAIKIN	DAIKIN	DAIKIN	DAIKIN	DAIKIN
	Compressor quantity		1 INV	1 INV	1 INV+1 FIX	1 INV+1 FIX	1 INV+1 FIX	1 INV+1 INV	1 INV+1 INV	(1 INV) +(1 INV+1 FIX)	(1 INV) +(1 INV+1 FIX)	(1 INV) +(1 INV+1 FIX)	(1 INV) +(1 INV+1 FIX)	(1 INV) +(1 INV+1 FIX)	(1 INV) +(1 INV+1 FIX)	1 INV +1 INV +(1 INV+1 FIX)	1 INV +1 INV +(1 INV+1 FIX)	1 INV +1 INV +(1 INV+1 FIX)	1 INV +1 INV +(1 INV+1 FIX)	1 INV +1 INV +(1 INV+1 FIX)	1 INV +1 INV +(1 INV+1 FIX)	1 INV +1 INV +(1 INV+1 FIX)	1 INV +1 INV +(1 INV+1 FIX)	
	Refrigerant type		R410A	R410A	R410A	R410A	R410A	R410A	R410A	R410A	R410A	R410A	R410A	R410A	R410A	R410A	R410A	R410A	R410A	R410A	R410A	R410A	R410A	R410A
	Refrigerant charge	kg	10	10	10	10	10	20	20	20	20	20	20	20	20	30	30	30	30	30	30	30	30	30
	Refrigerant liquid pipe	mm	9.52	9.52	12.7	12.7	12.7	15.88	15.88	15.88	15.88	15.88	19.05	19.05	19.05	19.05	19.05	19.05	19.05	19.05	19.05	19.05	19.05	19.05
	Refrigerant gas pipe	mm	22.22	22.22	25.4	25.4	28.58	28.58	28.58	28.58	28.58	28.58	31.8	31.8	31.8	31.8	31.8	38.1	38.1	38.1	38.1	38.1	38.1	38.1
	Oil equalization pipe	mm	9.52	9.52	9.52	9.52	9.52	9.52	9.52	9.52	9.52	9.52	9.52	9.52	9.52	9.52	9.52	9.52	9.52	9.52	9.52	9.52	9.52	9.52
	Total pipe length	m	300	300	300	300	300	300	300	300	300	300	300	300	300	300	300	300	300	300	300	300	300	300
Max. pipe length (Equivalent/Actual)	m	175/150	175/150	175/150	175/150	175/150	175/150	175/150	175/150	175/150	175/150	175/150	175/150	175/150	175/150	175/150	175/150	175/150	175/150	175/150	175/150	175/150	175/150	
Max drop between I.U. & O.U.	m	50/40	50/40	50/40	50/40	50/40	50/40	50/40	50/40	50/40	50/40	50/40	50/40	50/40	50/40	50/40	50/40	50/40	50/40	50/40	50/40	50/40	50/40	
External static pressure	Pa	50	50	50	50	50	50	50	50	50	50	50	50	50	50	50	50	50	50	50	50	50	50	
Connectable indoor unit ratio	%	50-130	50-130	50-130	50-130	50-130	50-130	50-130	50-130	50-130	50-130	50-130	50-130	50-130	50-130	50-130	50-130	50-130	50-130	50-130	50-130	50-130	50-130	
Connection ratio	Maximum number of indoor units		13	16	19	23	26	29	33	36	39	43	46	50	53	56	59	63	64	64	64	64	64	
	Cooling	°C	-5-43	-5-43	-5-43	-5-43	-5-43	-5-43	-5-43	-5-43	-5-43	-5-43	-5-43	-5-43	-5-43	-5-43	-5-43	-5-43	-5-43	-5-43	-5-43	-5-43	-5-43	
Working temp.	Heating	°C	-15-21	-15-21	-15-21	-15-21	-15-21	-15-21	-15-21	-15-21	-15-21	-15-21	-15-21	-15-21	-15-21	-15-21	-15-21	-15-21	-15-21	-15-21	-15-21	-15-21	-15-21	

* 1 outdoor above 50m outdoor below 40m.
 * All the specifications are tested under nominal condition (in cooling, indoor temp is 27°C DB/19°C WB, outdoor temp 35°C DB/24°C WB, in heating, indoor temp is 20°C DB, outdoor temp is 7°C DB/6°C WB).

MRV IV-C
MRV III-C
MRVIII-RC
MRV S
MRV W
Easy MRV
MRV AHU
MRV Indoor
Control System
Reference Projects

MRVIII-C(T1) 60Hz-460V-3Ph



8/10HP



12/14/16HP



Dual Frequency 60Hz-460V-3Ph
 DC Inverter Scroll Compressor & BLDC Fan
 5 Basic Modular Units: 8HP, 10HP, 12HP, 14HP, 16HP
 Free Combination up to 48HP with Incremental 2HP,
 Max. Indoor Units up to 64



Model		AV08GMVESA	AV10GMVESA	AV12GMVESA	AV14GMVESA	AV16GMVESA	AV18GMVESA	AV20GMVESA	AV22GMVESA	AV24GMVESA	AV26GMVESA	AV28GMVESA	AV30GMVESA	AV32GMVESA	AV34GMVESA	AV36GMVESA	AV38GMVESA	AV40GMVESA	AV42GMVESA	AV44GMVESA	AV46GMVESA	AV48GMVESA		
Combination model		/	/	/	/	/	AV08GMVESA	AV10GMVESA	AV10GMVESA	AV10GMVESA	AV10GMVESA	AV10GMVESA	AV10GMVESA	AV10GMVESA	AV10GMVESA	AV10GMVESA	AV10GMVESA	AV10GMVESA	AV10GMVESA	AV10GMVESA	AV10GMVESA	AV10GMVESA		
		/	/	/	/	/	AV10GMVESA	AV10GMVESA	AV12GMVESA	AV14GMVESA	AV16GMVESA	AV14GMVESA	AV16GMVESA	AV16GMVESA	AV10GMVESA	AV10GMVESA	AV14GMVESA	AV14GMVESA	AV16GMVESA	AV16GMVESA	AV16GMVESA	AV16GMVESA		
		/	/	/	/	/	/	/	/	/	/	/	/	/	AV14GMVESA	AV16GMVESA	AV14GMVESA	AV16GMVESA	AV16GMVESA	AV16GMVESA	AV16GMVESA	AV16GMVESA		
Capacity	Capacity range	HP	8	10	12	14	16	18.0	20.0	22.0	24.0	26.0	28.0	30	32	34	36	38.0	40	42.0	44.0	46.0	48.0	
	Cooling	kW	22.4	28	33.5	40	45	50.4	56.0	61.5	68.0	73.0	80.0	85	90	96	101	108.0	113	118.0	123.5	130.0	135.0	
Electrical parameters	Heating	kW	25	31.5	37.5	45	50	56.5	63.0	69.0	76.5	81.5	90.0	95	100	108	113	121.5	127	131.5	137.5	145.0	150.0	
	Power supply	PhV/Hz	3/460/60	3/460/60	3/460/60	3/460/60	3/460/60	3/460/60	3/460/60	3/460/60	3/460/60	3/460/60	3/460/60	3/460/60	3/460/60	3/460/60	3/460/60	3/460/60	3/460/60	3/460/60	3/460/60	3/460/60	3/460/60	
	Cooling	Rated power input	kW	5.27	7.36	10.00	11.40	13.40	12.63	14.72	17.36	18.76	20.76	22.80	24.80	26.80	26.12	28.12	30.16	32.16	34.16	36.80	38.20	40.20
		Max power input	kW	13.00	15.00	17.00	19.00	20.50	28.00	30.00	32.00	34.00	35.50	32.00	39.50	41.00	49.00	50.50	53.00	54.50	56.00	58.00	60.00	61.50
		Rated current	A	6.96	9.72	13.21	15.06	17.70	16.69	19.45	22.94	24.79	27.43	30.12	32.77	35.41	34.51	37.15	39.85	42.49	45.13	48.62	50.47	53.11
		Max current	A	17.18	19.82	22.46	25.10	27.08	37.00	39.64	42.28	44.92	46.90	50.20	52.18	54.16	64.74	66.72	70.02	72.00	73.98	76.62	79.26	81.24
	Heating	Rated power input	kW	5.89	7.97	10.00	11.60	13.50	13.86	15.94	17.97	19.57	21.47	23.20	25.10	27.00	27.54	29.44	31.17	33.07	34.97	37.00	38.60	40.50
		Max power input	kW	10.27	12.40	15.10	17.10	18.30	22.67	24.80	27.50	29.50	30.70	34.20	35.40	36.60	41.90	43.10	46.60	47.80	49.00	51.70	53.70	54.90
		Rated current	A	7.78	10.53	13.21	15.33	17.84	18.31	21.06	23.74	25.86	28.37	30.65	33.16	35.67	36.39	38.90	41.18	43.69	46.20	48.88	51.00	53.51
		Max current	A	13.57	16.38	19.95	22.59	24.18	29.95	32.77	36.33	38.98	40.56	45.19	46.77	48.36	55.36	56.94	61.57	63.15	64.74	68.31	70.95	72.53
Performance	EER		4.25	3.80	3.35	3.51	3.36	3.52	3.51	3.62	3.43	3.52	3.51	3.62	3.36	3.58	3.59	3.58	3.51	3.45	3.36	3.40	3.36	
	COP		4.24	3.95	3.75	3.88	3.70	4.08	3.95	3.84	3.91	3.80	3.88	3.78	3.70	3.92	3.84	3.90	3.83	3.76	3.72	3.76	3.70	
	Air flow (H)	m³/h	11000	11000	14100	14100	14100	22000	22000	25100	25100	25100	28200.0	28200	28200	36100	36100	39200.0	39200	39200	42300	42300	42300	
	Sound pressure level (H)	dB(A)	57	57	60	60	60	60	61	61	61	61	62	62	62	63	63	63	63	63	64	64	64	
Installation	Sound power level (H)	dB(A)	73	73	76	76	76	77	77	78	78	78	79	79	79	81	81	81	81	81	82	82	82	
	External dimensions (W/D/H)	mm	990/750/1808	990/750/1808	1390/750/1808	1390/750/1808	1390/750/1808	(990*1808*750)*2	(990/750/1808)*2	990/750/1808	990/750/1808	990/750/1808	990/750/1808	1390/750/1808	1390/750/1808	1390/750/1808	1390/750/1808	990/750/1808*2	(990/750/1808)	(990/750/1808)	(990/750/1808)	(1390/750/1808)	(1390/750/1808)	(1390/750/1808)*3
	Shipping dimensions (W/D/H)	mm	1090/860/1990	1090/860/1990	1490/860/1990	1490/860/1990	1490/860/1990	(1090*1990*860)*2	(1090/860/1990)*2	1090/860/1990	1090/860/1990	1090/860/1990	1090/860/1990	1490/860/1990	1490/860/1990	1490/860/1990	1490/860/1990	1090/860/1990	(1090/860/1990)	(1090/860/1990)	(1090/860/1990)	(1490/860/1990)	(1490/860/1990)	(1490/860/1990)*3
	Net/Shipping weight	kg	240/255	240/255	368/386	368/386	368/386	240/255+240/255	(240/255)*2	240/255+368/386	240/255+368/386	240/255+368/386	240/255+368/386	368/386+368/386	368/386+368/386	368/386+368/386	(368/386)*2	240/255*2+368/386	240/255*2+368/386	240/255+368/386+368/386	240/255+368/386+368/386	240/255+368/386+368/386	240/255+368/386+368/386	(368/386)*3
	Compressor type		DC INV. SCROLL	DC INV. SCROLL	DC INV. SCROLL	DC INV. SCROLL	DC INV. SCROLL	DC INV. SCROLL	DC INV. SCROLL	DC INV. SCROLL	DC INV. SCROLL	DC INV. SCROLL	DC INV. SCROLL	DC INV. SCROLL	DC INV. SCROLL	DC INV. SCROLL	DC INV. SCROLL	DC INV. SCROLL	DC INV. SCROLL	DC INV. SCROLL	DC INV. SCROLL	DC INV. SCROLL	DC INV. SCROLL	DC INV. SCROLL
	Compressor brand		DAIKIN	DAIKIN	DAIKIN	DAIKIN	DAIKIN	DAIKIN	DAIKIN	DAIKIN	DAIKIN	DAIKIN	DAIKIN	DAIKIN	DAIKIN	DAIKIN	DAIKIN	DAIKIN	DAIKIN	DAIKIN	DAIKIN	DAIKIN	DAIKIN	DAIKIN
	Compressor quantity		1 INV	1 INV	1 INV+1 FIX	1 INV+1 FIX	1 INV+1 FIX	1 INV+1 INV	1 INV*2	1 INV	1 INV	1 INV	1 INV	1 INV	1 INV	1 INV	1 INV	1 INV	1 INV	1 INV	1 INV	1 INV	1 INV	1 INV
	Refrigerant type		R410A	R410A	R410A	R410A	R410A	R410A	R410A	R410A	R410A	R410A	R410A	R410A	R410A	R410A	R410A	R410A	R410A	R410A	R410A	R410A	R410A	R410A
	Refrigerant charge	kg	10	10	10	10	10	20	20	20	20	20	20	20	20	20	20	20	20	20	20	20	20	20
	Refrigerant liquid pipe	mm	9.52	9.52	12.7	12.7	12.7	15.88	15.88	15.88	15.88	15.88	19.05	19.05	19.05	19.05	19.05	19.05	19.05	19.05	19.05	19.05	19.05	19.05
	Refrigerant gas pipe	mm	22.22	22.22	25.4	25.4	25.4	28.58	28.58	28.58	28.58	28.58	31.8	31.8	31.8	31.8	31.8	31.8	31.8	31.8	31.8	31.8	31.8	31.8
	Oil equalization pipe	mm	9.52	9.52	9.52	9.52	9.52	9.52	9.52	9.52	9.52	9.52	9.52	9.52	9.52	9.52	9.52	9.52	9.52	9.52	9.52	9.52	9.52	9.52
	Total pipe length	m	300	300	300	300	300	300	300	300	300	300	300	300	300	300	300	300	300	300	300	300	300	300
	Max pipe length (Equivalent/Actual)	m	175/150	175/150	175/150	175/150	175/150	175/150	175/150	175/150	175/150	175/150	175/150	175/150	175/150	175/150	175/150	175/150	175/150	175/150	175/150	175/150	175/150	175/150
	Max drop between I.U.&O.U	m	50/40	50/40	50/40	50/40	50/40	50/40	50/40	50/40	50/40	50/40	50/40	50/40	50/40	50/40	50/40	50/40	50/40	50/40	50/40	50/40	50/40	50/40
External static pressure	Pa	50	50	50	50	50	50	50	50	50	50	50	50	50	50	50	50	50	50	50	50	50	50	
Connectable indoor unit ratio	%	50-130	50-130	50-130	50-130	50-130	50-130	50-130	50-130	50-130	50-130	50-130	50-130	50-130	50-130	50-130	50-130	50-130%	50-130	50-130	50-130	50-130	50-130	
Maximum number of indoor units		13	16	19	23	26	26	26	26	26	26	26	26	26	26	26	26	26	26	26	26	26	26	
Working temp.	Cooling	°C	-5-43	-5-43	-5-43	-5-43	-5-43	-5-43	-5-43	-5-43	-5-43	-5-43	-5-43	-5-43	-5-43	-5-43	-5-43	-5-43	-5-43	-5-43	-5-43	-5-43	-5-43	
	Heating	°C	-15-21	-15-21	-15-21	-15-21	-15-21	-15-21	-15-21	-15-21	-15-21	-15-21	-15-21	-15-21	-15-21	-15-21	-15-21	-15-21	-15-21	-15-21	-15-21	-15-21	-15-21	

* 1 outdoor above 50m outdoor below 40m.
 * All the specifications are tested under nominal condition in cooling. Indoor temp is 27°C DB/19°C WB. Outdoor temp 35°C DB/24°C WB. In heating. Indoor temp is 20°C DB. Outdoor temp is 7°C DB/6°C WB.

MRV III-C(T3) 50/60Hz-380~400v-3Ph



8HP



10/12HP



Dual Frequency 50/60Hz-380~400v-3Ph
 DC Inverter Scroll Compressor & BLDC Fan
 3 Basic Modular Units: 8HP, 10HP, 12HP
 Free Combination up to 36HP with Incremental 2HP,
 Max. Indoor Units up to 36
 High Ambient Operation up to 52°C



Model		AV08NMVERB	AV10NMVERB	AV12NMVERB	AV16NMVERB	AV18NMVERB	AV20NMVERB	AV22NMVERB	AV24NMVERB	AV26NMVERB	AV28NMVERB	AV30NMVERB	AV32NMVERB	AV34NMVERB	AV36NMVERB	
Combination model		/	/	/	AV08NMVERB	AV08NMVERB	AV10NMVERB	AV10NMVERB	AV12NMVERB	AV08NMVERB	AV08NMVERB	AV10NMVERB	AV10NMVERB	AV10NMVERB	AV12NMVERB	
Capacity		HP	8	10	12	16	18	20	22	24	26	28	30	32	34	36
Cooling capacity		kW	22.6	28.0	33.5	45.2	50.6	56	61.5	67.0	73.2	78.7	84.0	89.5	95.0	100.5
Heating capacity		kW	25.0	31.5	37.5	50.0	56.5	63.0	69.0	75.0	81.5	87.5	94.5	100.5	106.5	112.5
Power supply		Ph/V/Hz	3/380-400/50/60	3/380-400/50/60	3/380-400/50/60	3/380-400/50/60	3/380-400/50/60	3/380-400/50/60	3/380-400/50/60	3/380-400/50/60	3/380-400/50/60	3/380-400/50/60	3/380-400/50/60	3/380-400/50/60	3/380-400/50/60	3/380-400/50/60
Cooling		Rated power input	kW	6.28	7.81	9.36	12.6	14.1	15.62	17.2	18.7	20.4	21.9	23.4	25.0	26.5
		Max. power input	kW	14.7	17.54	20.48	29.4	32.2	35.08	38.0	41.0	46.9	49.9	52.6	55.6	58.5
		Rated current	A	10.6	13.18	15.8	21.2	23.8	26.36	29.0	31.6	34.4	37.0	39.5	42.2	44.8
		Max. current	A	23.4	27.9	32.37	46.8	51.3	55.8	60.3	64.7	74.7	79.2	83.7	88.2	92.6
Heating		Rated power input	kW	5.98	7.51	9.11	12.0	13.49	15.02	16.6	18.2	19.5	21.1	22.5	24.1	25.7
		Max. power input	kW	11.9	14.6	17.8	23.8	26.5	29.2	32.4	35.6	38.4	41.6	43.8	47.0	50.2
		Rated current	A	10.1	12.68	15.38	20.2	22.8	25.36	28.1	30.8	32.9	35.6	38.0	40.7	43.4
		Max. current	A	19	23.3	28.4	38.0	42.3	46.6	51.7	56.8	61.3	66.4	69.9	75.0	80.1
EER			3.60	3.59	3.58	3.60	3.59	3.59	3.58	3.58	3.59	3.59	3.58	3.58	3.58	3.58
COP			4.18	4.19	4.12	4.18	4.19	4.19	4.15	4.12	4.19	4.15	4.19	4.16	4.14	4.12
Air flow (H)		m³/h	11000	14100	14100	22000.0	25100.0	28200	28200.0	28200.0	36100.0	36100.0	42300.0	42300.0	42300.0	42300
Sound pressure level (H)		dB(A)	60	65	65	63	66	68	68	68	67	67	70	70	70	70
Sound power level (H)		dB(A)	76	81	81	80	83	85	85	85	85	85	88	88	88	88
External dimensions(W/D/H)		mm	990/750/1808	1390/750/1808	1390/750/1808	990/750/1808 +990/750/1808	990/750/1808 +1390/750/1808	1390/750/1808 +1390/750/1808	1390/750/1808 +1390/750/1808	1390/750/1808 +1390/750/1808	990/750/1808 +990/750/1808 +1390/750/1808	990/750/1808 +990/750/1808 +1390/750/1808	1390/750/1808 +1390/750/1808 +1390/750/1808	1390/750/1808 +1390/750/1808 +1390/750/1808	1390/750/1808 +1390/750/1808 +1390/750/1808	1390/750/1808 +1390/750/1808 +1390/750/1808
Shipping dimensions(W/D/H)		mm	1090/860/1990	1490/860/1990	1490/860/1990	1090/860/1990 +1090/860/1990	1090/860/1990 +1490/860/1990	1490/860/1990 +1490/860/1990	1490/860/1990 +1490/860/1990	1490/860/1990 +1490/860/1990	1090/860/1990 +1090/860/1990 +1490/860/1990	1090/860/1990 +1090/860/1990 +1490/860/1990	1490/860/1990 +1490/860/1990 +1490/860/1990	1490/860/1990 +1490/860/1990 +1490/860/1990	1490/860/1990 +1490/860/1990 +1490/860/1990	1490/860/1990 +1490/860/1990 +1490/860/1990
Net/Shipping weight		kg	240/255	360/378	368/386	480/510	600/633	720/756	728/764	720/756	840/888	848/896	1080/1134	1088/1142	1096/1150	1104/1158
Compressor type			DC INV SCROLL	DC INV SCROLL	DC INV SCROLL	DC INV SCROLL	DC INV SCROLL	DC INV SCROLL	DC INV SCROLL	DC INV SCROLL	DC INV SCROLL	DC INV SCROLL	DC INV SCROLL	DC INV SCROLL	DC INV SCROLL	DC INV SCROLL
Compressor quantity			1 INV	1 INV +1 FIX	1 INV +1 FIX	2 INV	2 INV +1 FIX	2 INV +2 FIX	2 INV +2 FIX	2 INV +2 FIX	3 INV +1 FIX	3 INV +1 FIX	3 INV +3 FIX	3 INV +3 FIX	3 INV +3 FIX	3 INV +3 FIX
Refrigerant type			R410A	R410A	R410A	R410A	R410A	R410A	R410A	R410A	R410A	R410A	R410A	R410A	R410A	R410A
Refrigerant charge		kg	10	10	10	20	20	20	20.0	20.0	30.0	30.0	30.0	30.0	30.0	30
Refrigerant liquid pipe		mm	9.52	12.7	12.7	15.88	15.88	15.88	19.05	19.05	19.05	19.05	19.05	19.05	19.05	19.05
Refrigerant gas pipe		mm	22.22	25.4	28.58	28.58	28.58	28.58	31.8	31.8	31.8	31.8	31.8	31.8	31.8	31.8
Oil equalization pipe		mm	9.52	9.52	9.52	9.52	9.52	9.52	9.52	9.52	9.52	9.52	9.52	9.52	9.52	9.52
Total pipe length		m	300	300	300	300	300	300	300	300	300	300	300	300	300	300
Max. pipe length(Equivalent/Actual)		m	175/150	175/150	175/150	175/150	175/150	175/150	175/150	175/150	175/150	175/150	175/150	175/150	175/150	175/150
Max drop between I.U.&O.U		m	50/40	50/40	50/40	50/40	50/40	50/40	50/40	50/40	50/40	50/40	50/40	50/40	50/40	50/40
External static pressure		Pa	50	50	50	50	50	50	50	50	50	50	50	50	50	50
Connection ratio		%	50-130	50-130	50-130	50-130	50-130	50-130	50-130	50-130	50-130	50-130	50-130	50-130	50-130	50-130
Maximum number of indoor units			10	13	16	20	20	24	24	28	28	32	32	36	36	36
Working temp.		°C	-5-52	-5-52	-5-52	-5-52	-5-52	-5-52	-5-52	-5-52	-5-52	-5-52	-5-52	-5-52	-5-52	-5-52
		°C	-15-15.5	-15-15.5	-15-15.5	-15-15.5	-15-15.5	-15-15.5	-15-15.5	-15-15.5	-15-15.5	-15-15.5	-15-15.5	-15-15.5	-15-15.5	-15-15.5

* 1 outdoor above 50m outdoor below 40m.
 * All the specifications are tested under nominal condition(In cooling, Indoor temp is 27°C DB/19°C WB, Outdoor temp 35°C DB/24°C WB, In heating, Indoor temp is 20°C DB, Outdoor temp is 7°C DB/6°C WB)



MRV III-RC

- | 051 Features & Benefits
- | 061 MRV III-RC (Heat Recovery)



FEATURES & BENEFITS

System Introduction

What is MRVIII-RC

- Cooling and heating simultaneously with only one outdoor unit
- Heat recovery system

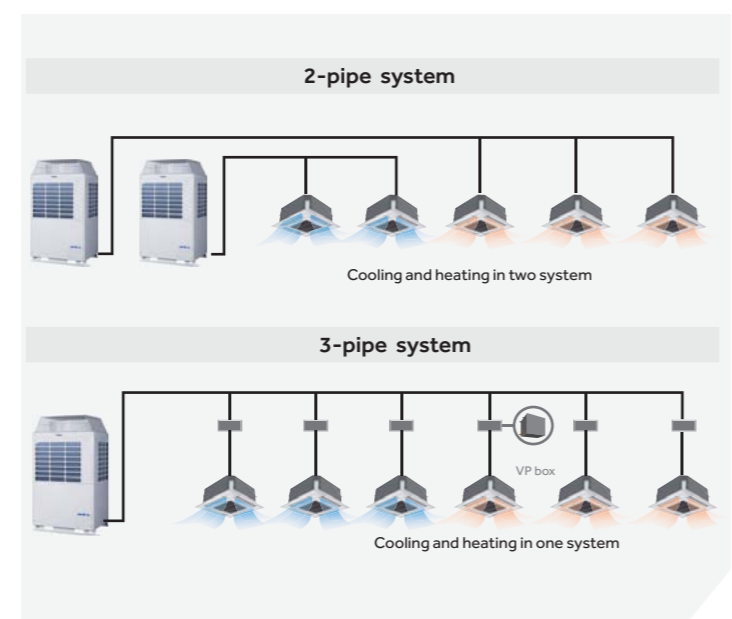

Variable operation mode in one system

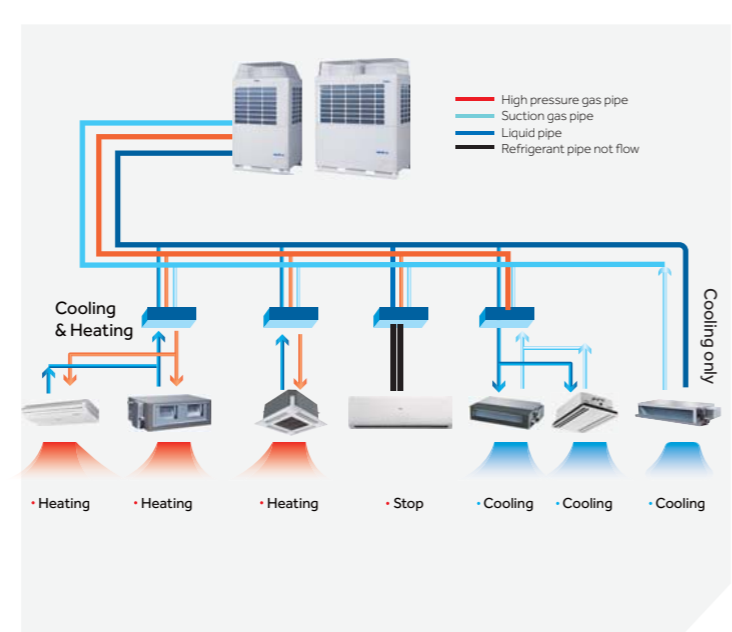

System Introduction

Typical 3 pipe system

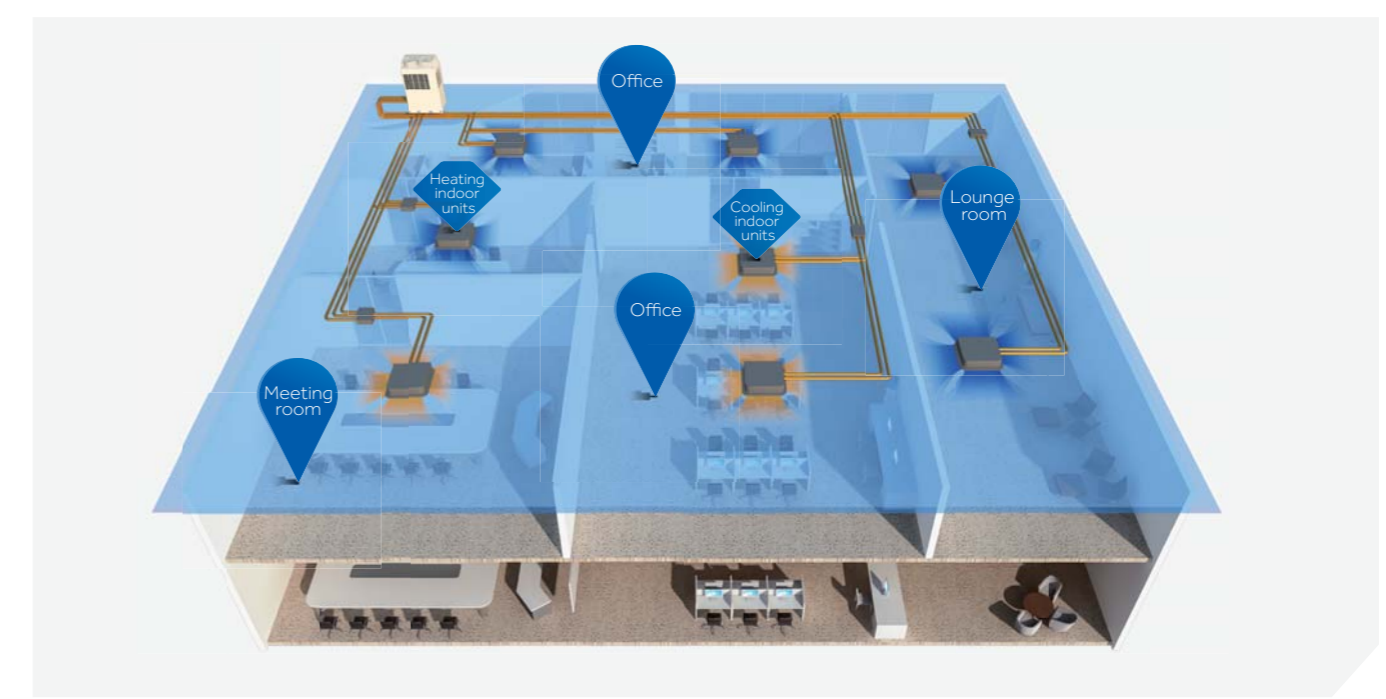

All cooling circuit

- 12/14/16HP double compressor module for example

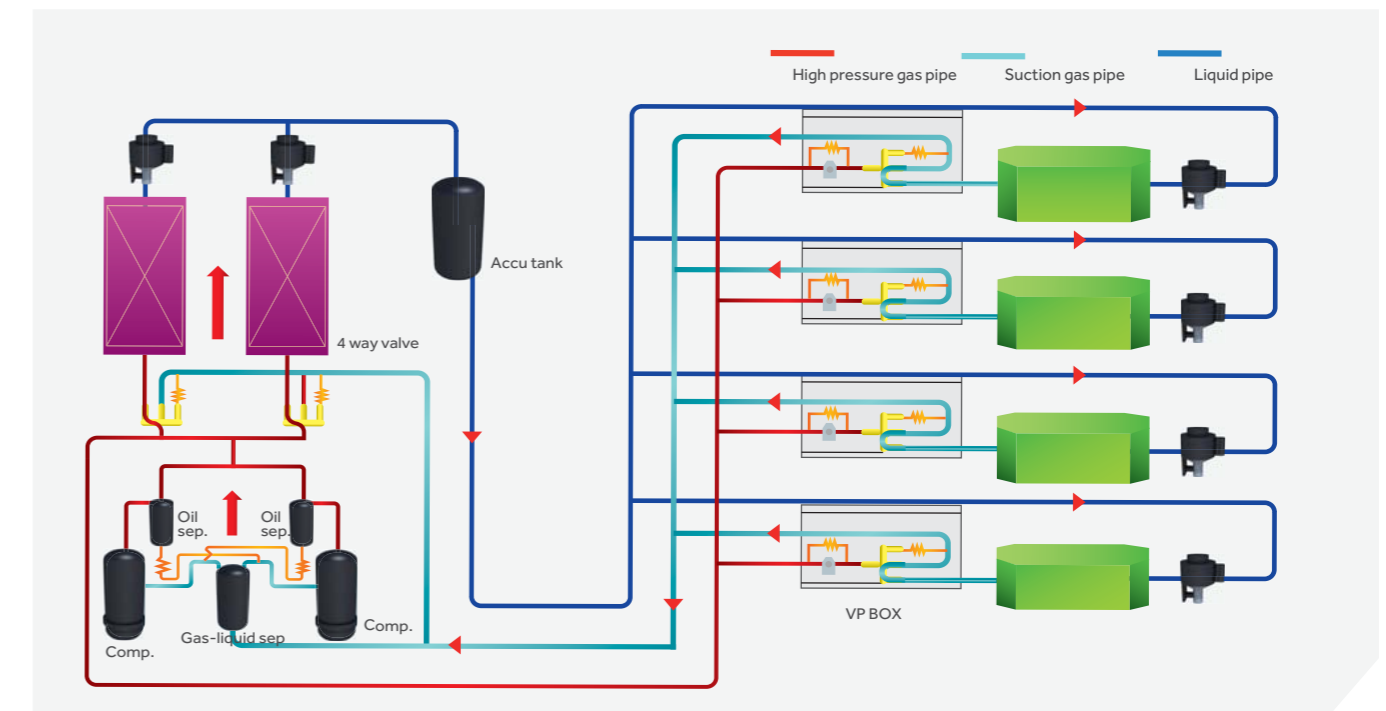

FEATURES & BENEFITS

System Introduction

All heating circuit

•12/14/16HP double compressor module for example

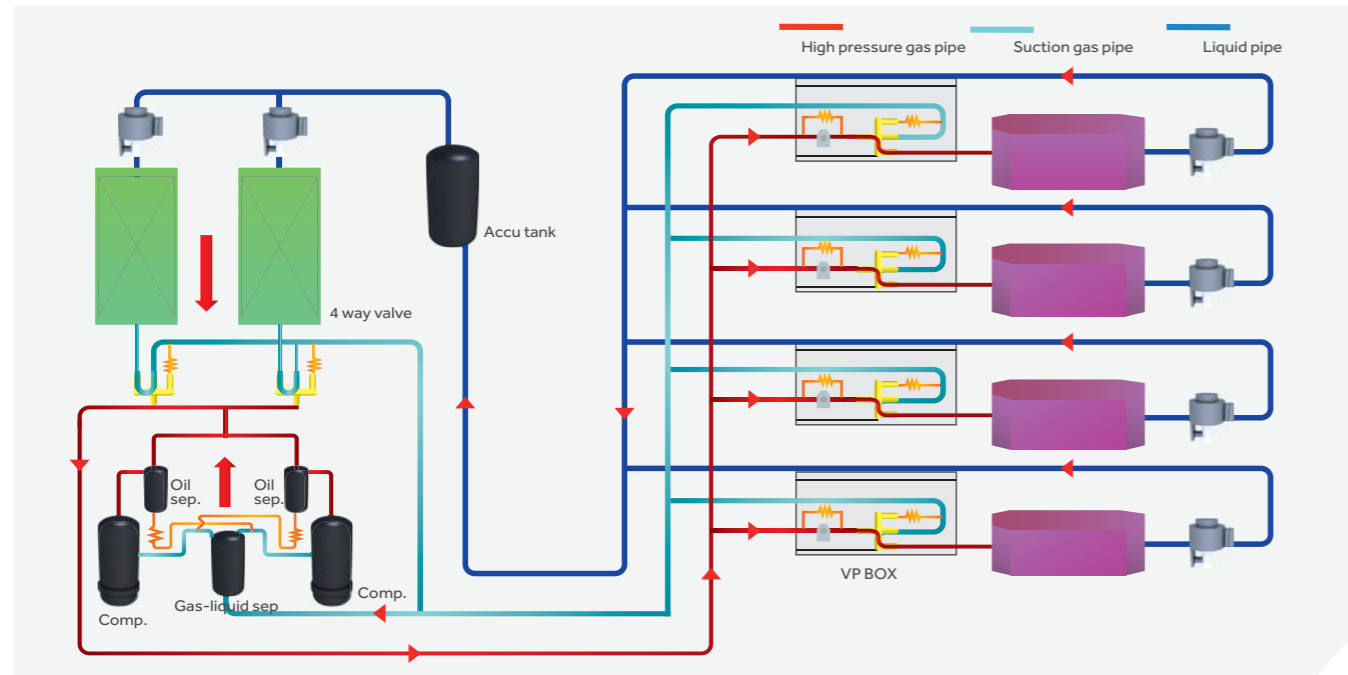

Cooling > heating circuit

•12/14/16HP double compressor module for example

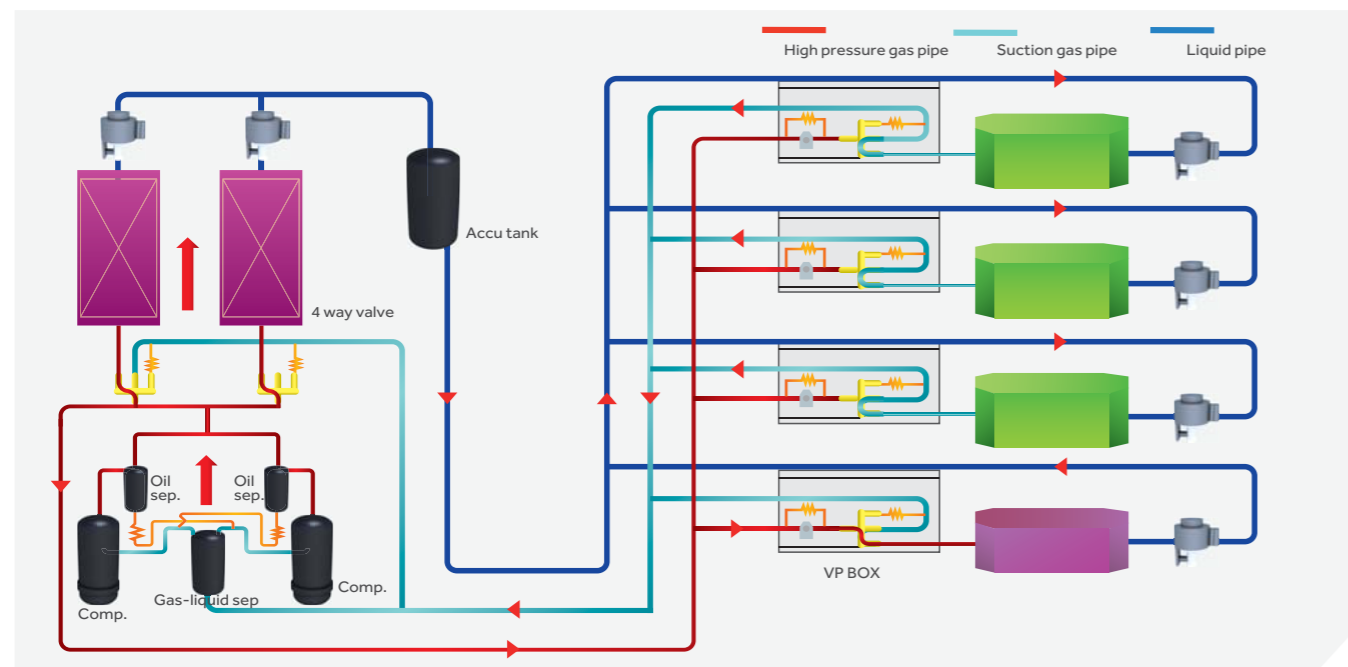

System Introduction

Cooling < heating circuit

•12/14/16HP double compressor module for example

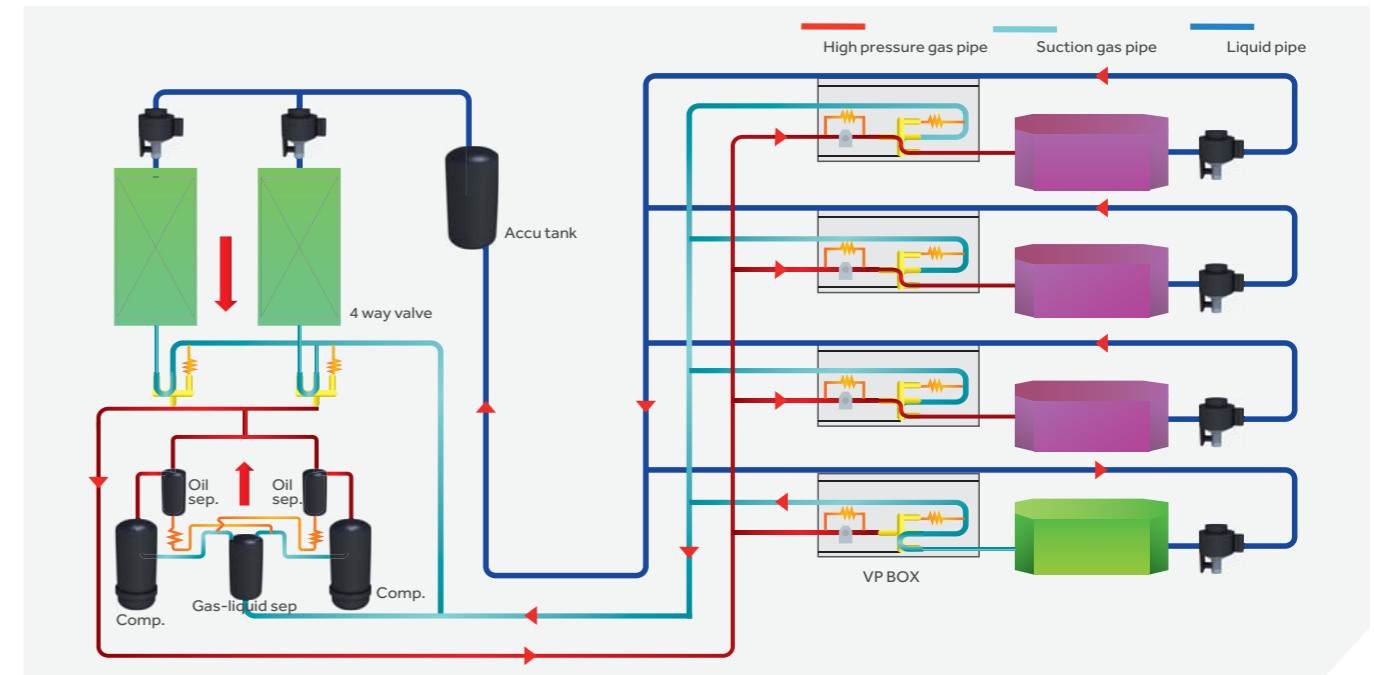

Cooling = heating circuit

•12/14/16HP double compressor module for example

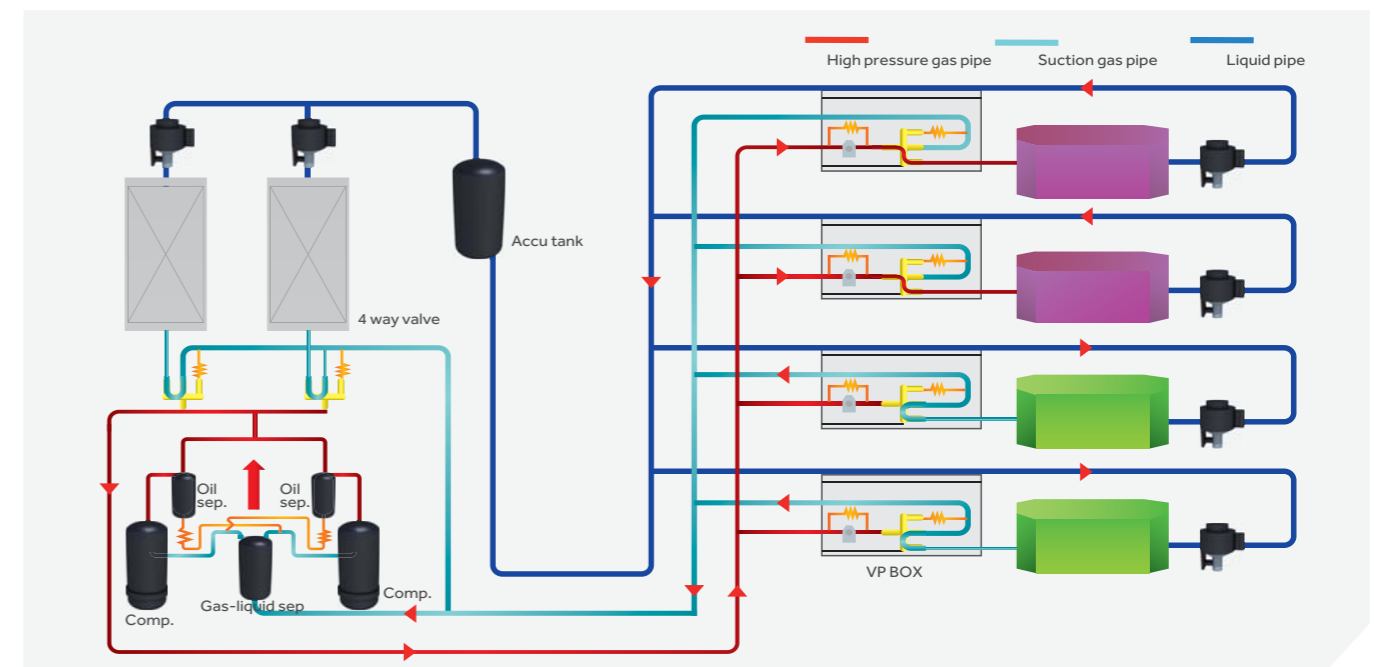

FEATURES & BENEFITS

System Introduction

Light part load cooling

•12/14/16HP double compressor module for example, little indoor heating, others off

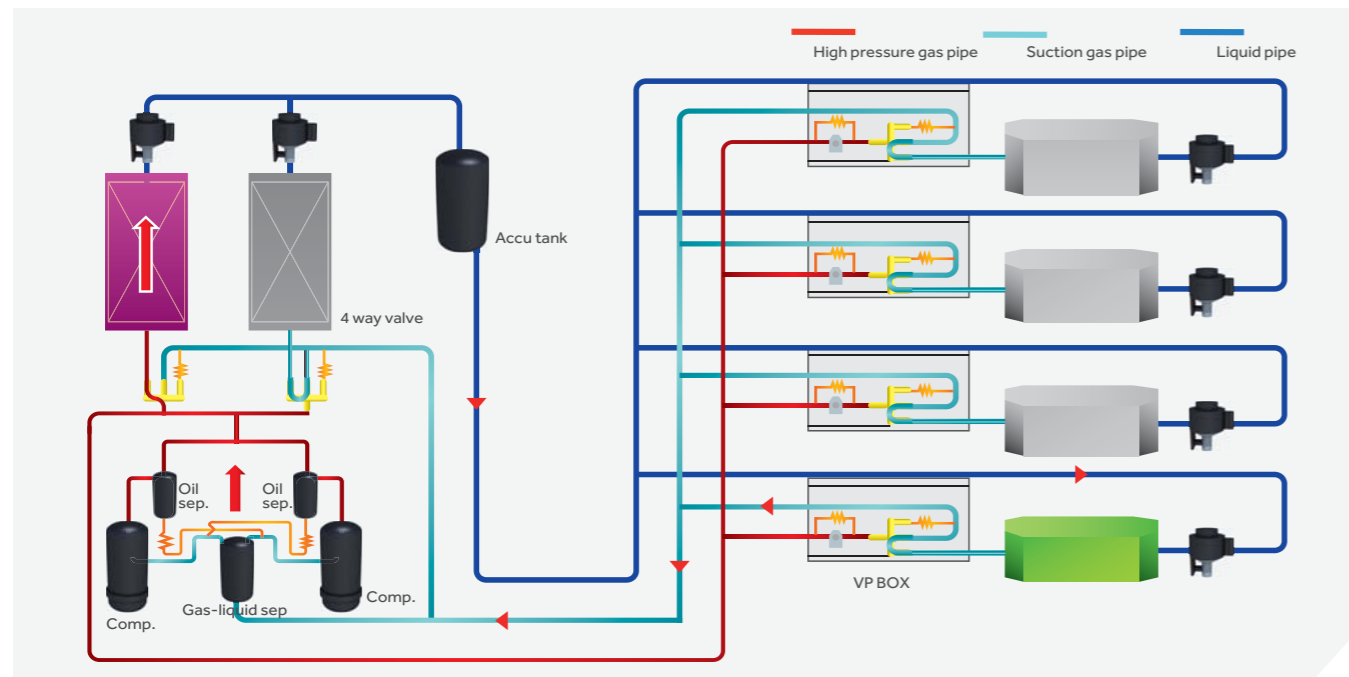

Light part load heating

•12/14/16HP double compressor module for example, little indoor heating, others off

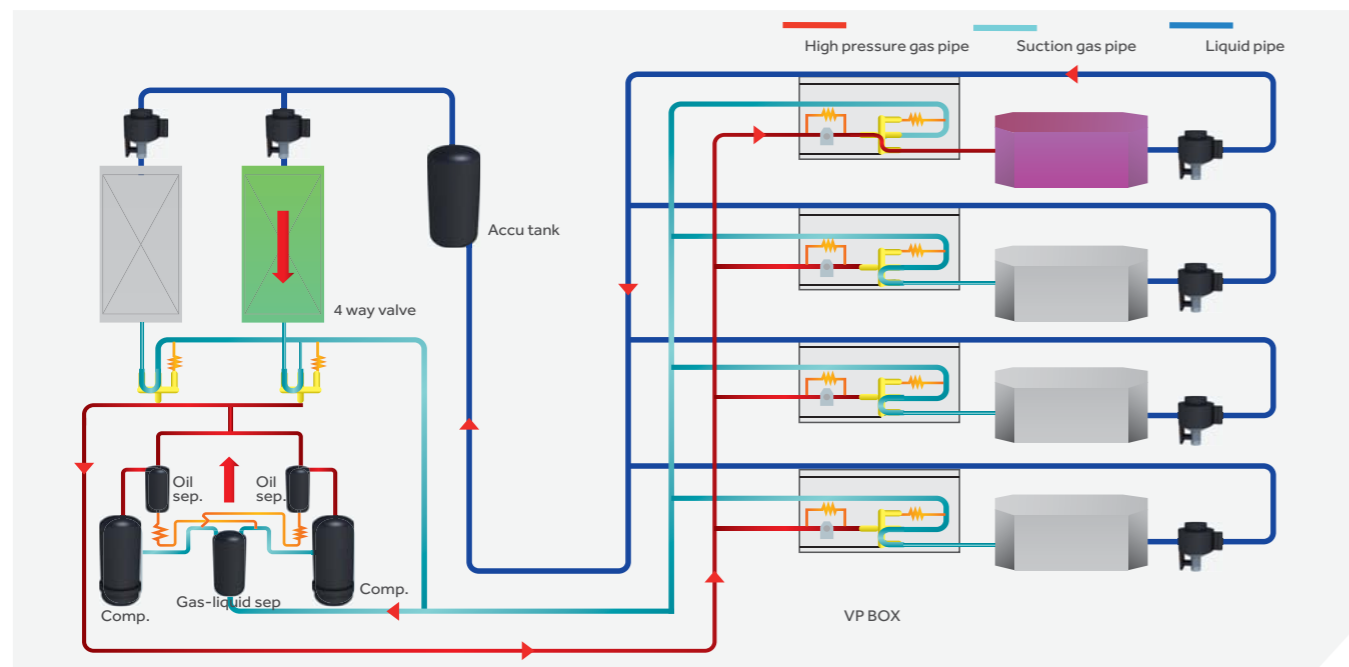

Outdoor Structure

Inner system

Core Parts: For 12/14/16 Single Module

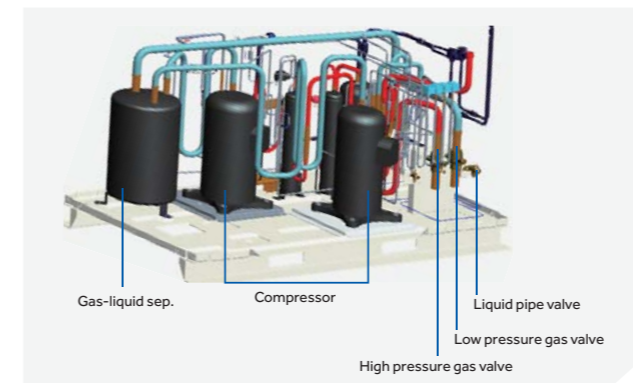

Inner system

Core Parts: For 12/14/16 Single Module

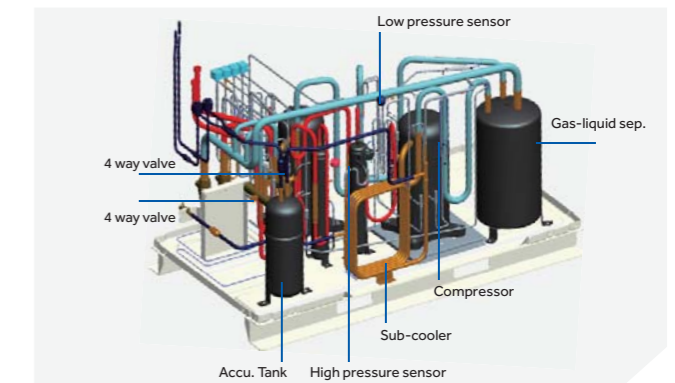

User friendly outdoor structure

Core Technologies and Parts

Patent fan design and DC fan motor

- Air flow improved by 17.5% with patent fan design
- Noise reduced 3 dB(A) with DC fan motor

2 stages heat exchanger

Separate control and heat exchanger size can be adjusted, effectively cope with small load operation, to ensure reliable operation

Forced heat dissipation fan

Forced heat dissipation fan inside the electric control box, to ensure the stable internal temperature and stable system operation

4 way air return

Reduce the heat exchanger height(650mm), and the upper and lower wind speed uniform and high efficiency

Double EEV design

The double EEV control the 2 stages heat exchanger separately, which can adjust the condenser volume

DC Inverter scroll Compressor

- DC inverter scroll compressor from Mitsubishi electric
- For big module, also with another fixed-speed compressor from mitsubishi electric



Vp (valve pipe) box structure

Overview

Individual Valve + Pipe Box for Heat Recovery

- High comfort: Individual control box and change over for one group indoor units
- Super slim built-in height: only 180mm
- Threaded joint connection, easy for installation

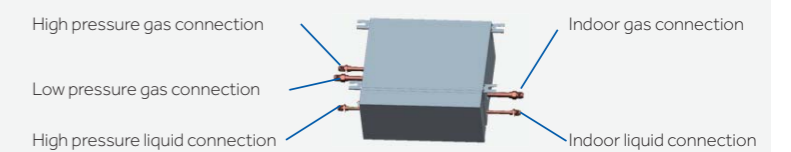

Model name	Max.capacity of indoor(kw)	Power Supply	Max. indoor units	Dimension
VP1-112A	x≤11.2	1/220-240/50/60	5	400/365/180
VP1-180A	11.2<x≤18	1/220-240/50/60	8	400/365/180
VP1-280A	18<x≤28	1/220-240/50/60	8	400/365/180

FEATURES & BENEFITS

System Introduction

Typical 3 pipe system

The heat discharged from outdoor unit can be used to cooling Indoor units. It can save energy above 30% averagely

Mode	Heat Recovery system operation	Part Load	Energy Saving
Cooling only (10HP outdoor each indoor 2HP)			0%
Heating only (10HP outdoor)			0%
Cooling>Heating			20%
Cooling=Heating			50%
Cooling<Heating			40%

FEATURES & BENEFITS

System Introduction

Wide temperature operation range

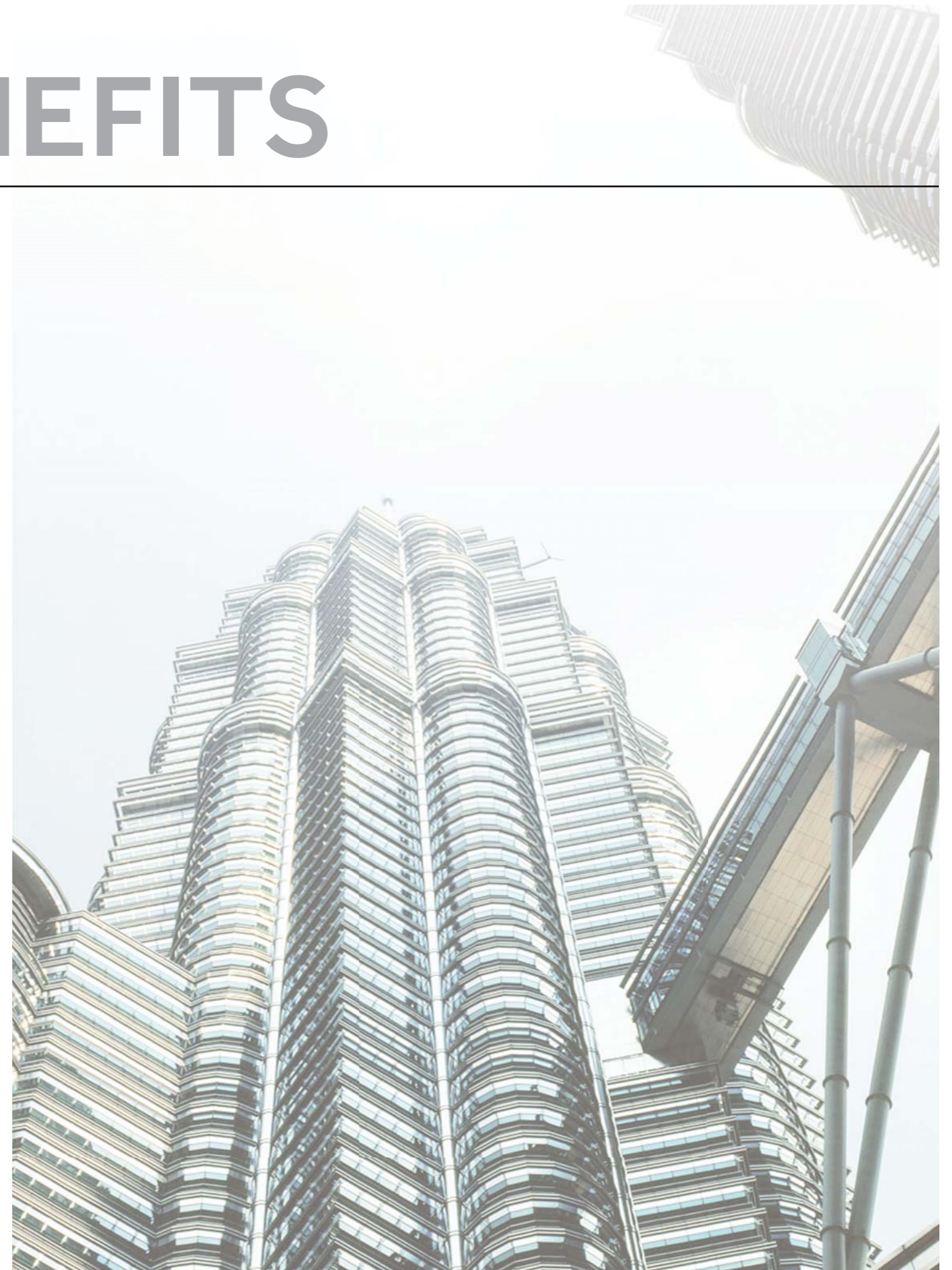
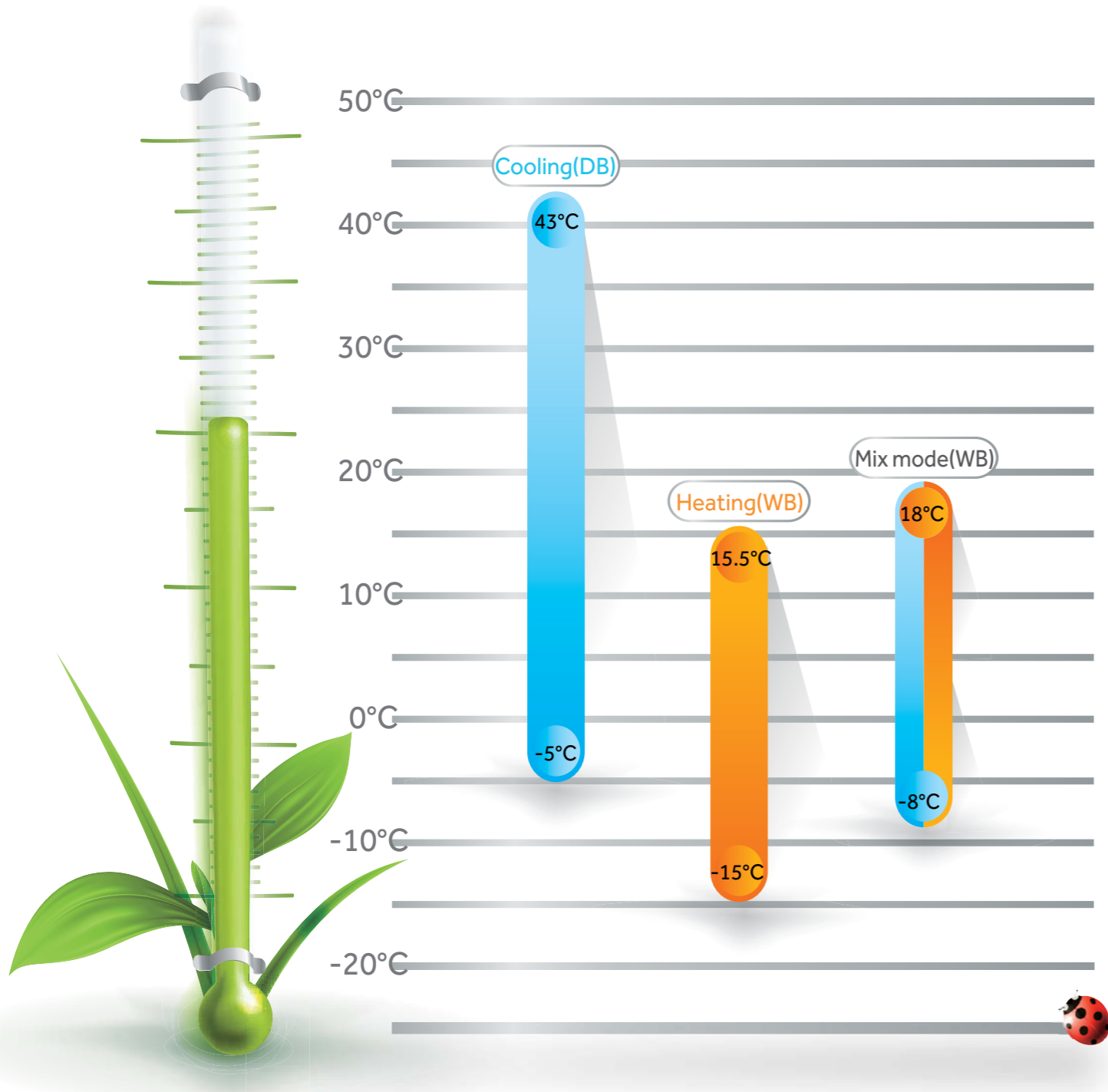

MRV III-RC (HEAT RECOVERY)



8/10HP



12/14/16HP



Power Supply: 3/380-400/50/60
 DC Inverter Scroll Compressor & BLDC Fan
 5 Basic Single Modular Units: 8HP, 10HP, 12HP, 14HP, 16HP
 Max. 3 Modules Combination up to 48HP,
 Max Connected Indoor Units up to 64.
 Compatible with all the MRV Indoor Units



Model		AV08IMVUSA	AV10IMVUSA	AV12IMVUSA	AV14IMVUSA	AV16IMVUSA	AV18IMVUSA	AV20IMVUSA	AV22IMVUSA	AV24IMVUSA		AV26IMVUSA	AV28IMVUSA	AV30IMVUSA	AV32IMVUSA	AV34IMVUSA	AV36IMVUSA	AV38IMVUSA	AV40IMVUSA	AV42IMVUSA	AV44IMVUSA	AV46IMVUSA	AV48IMVUSA		
Combination model		/	/	/	/	/	AV08IMVUSA	AV10IMVUSA	AV10IMVUSA	AV10IMVUSA		AV10IMVUSA	AV14IMVUSA	AV14IMVUSA	AV16IMVUSA	AV10IMVUSA	AV10IMVUSA	AV10IMVUSA	AV10IMVUSA	AV10IMVUSA	AV12IMVUSA	AV14IMVUSA	AV16IMVUSA		
Capacity	Capacity range	HP	8	10	12	14	16	18	20	22	24		26	28	30	32	34	36	38	40	42	44	46	48	
	Cooling	kW	22.4	28	33.5	40	45	50.4	56	61.5	68		73	80	85	90	96	101	106.5	113	118	123.5	130	135	
	Heating	kW	25	31.5	37.5	45	50	56.5	63	69	76.5		81.5	90	95	100	108	113	119	126.5	131.5	137.5	145	150	
	Power supply	Ph/V/Hz	3/380-400/50/60	3/380-400/50/60	3/380-400/50/60	3/380-400/50/60	3/380-400/50/60	3/380-400/50/60	3/380-400/50/60	3/380-400/50/60	3/380-400/50/60		3/380-400/50/60	3/380-400/50/60	3/380-400/50/60	3/380-400/50/60	3/380-400/50/60	3/380-400/50/60	3/380-400/50/60	3/380-400/50/60	3/380-400/50/60	3/380-400/50/60	3/380-400/50/60	3/380-400/50/60	
Electrical parameters	Cooling	Rated power input	kW	5.81	7.55	9.18	12.3	14.1	13.36	15.1	16.73		21.65	24.6	26.4	28.2	27.4	29.2	30.83	33.95	35.75	37.38	40.5	42.3	
		Max power input	kW	12.37	14.7	17.54	18.55	20.48	27.07	29.4	32.24	33.25		35.18	37.1	39.03	40.96	47.95	49.88	52.72	53.73	55.66	58.5	59.51	61.44
		Rated current	A	9.49	12.33	15.00	20.10	23.04	21.83	24.67	27.33	32.43		35.37	40.19	43.13	46.07	44.76	47.71	50.37	55.47	58.41	61.07	66.17	69.11
		Max current	A	19.85	23.4	27.9	29.5	32.37	43.25	46.8	51.3	52.9		55.77	59	61.87	64.74	76.3	79.17	83.67	85.27	88.14	92.64	94.24	97.11
	Heating	Rated power input	kW	6.1	7.97	9.15	11.1	13.5	14.07	15.94	17.12	19.07		21.47	22.2	24.6	27	27.04	29.44	30.62	32.57	34.97	36.15	38.1	40.5
		Max power input	kW	9.77	11.9	14.6	16.6	17.8	21.67	23.8	26.5	28.5		29.7	33.2	34.4	35.6	40.4	41.6	44.3	46.3	47.5	50.2	52.2	53.4
		Rated current	A	9.97	13.02	14.95	18.13	22.06	22.99	26.04	27.97	31.16		35.08	36.27	40.19	44.11	44.18	48.10	50.03	53.21	57.13	59.06	62.25	66.17
		Max current	A	15.7	19	23.3	26.5	28.4	34.7	38	42.3	45.5		47.4	53	54.9	56.8	64.5	66.4	70.7	73.9	75.8	80.1	83.3	85.2
		EER		3.86	3.71	3.65	3.25	3.19	3.77	3.71	3.68	3.43		3.37	3.25	3.22	3.19	3.50	3.46	3.45	3.33	3.30	3.30	3.21	3.19
		COP		4.10	3.95	4.10	4.05	3.70	4.02	3.95	4.03	4.01		3.80	4.05	3.86	3.70	3.99	3.84	3.89	3.88	3.76	3.80	3.81	3.70
Performance	Air flow (H)	m³/h	11100	11100	14100	14100	14100	22200	22200	25200	25200		25200	28200	28200	28200	36300	36300	39300	39300	42300	42300	42300	42300	
	Sound pressure level (H)	dB(A)	57	57	60	60	60	60	61	61	61		61	62	62	62	63	63	63	63	63	64	64	64	
	Sound power level (H)	dB(A)	73	73	76	76	76	77	77	78	78		78	79	79	79	81	81	81	81	81	82	82	82	
Installation	External dimensions (W/D/H)	mm	990/750/1808	990/750/1808	1390/1808/750	1390/1808/750	1390/1808/750	990/750/1808+ 990/750/1808	990/750/1808+ 990/750/1808	990/750/1808+ 1390/750/1808	990/750/1808+ 1390/750/1808		990/750/1808+ 1390/750/1808	1390/750/1808+ 1390/750/1808	1390/750/1808+ 1390/750/1808	1390/750/1808+ 1390/750/1808	990/750/1808+ 1390/750/1808	990/750/1808+ 1390/750/1808	990/750/1808+ 1390/750/1808	990/750/1808+ 1390/750/1808	990/750/1808+ 1390/750/1808	1390/750/1808+ 1390/750/1808	1390/750/1808+ 1390/750/1808	1390/750/1808+ 1390/750/1808	
	Shipping dimensions (W/D/H)	mm	1090/860/1990	1090/860/1990	1490/1990/860	1490/1990/860	1490/1990/860	1090/860/1990+ 1090/860/1990	1090/860/1990+ 1090/860/1990	1090/860/1990+ 1490/860/1990	1090/860/1990+ 1490/860/1990		1090/860/1990+ 1490/860/1990	1490/860/1990+ 1490/860/1990	1490/860/1990+ 1490/860/1990	1490/860/1990+ 1490/860/1990	1090/860/1990+ 1090/860/1990	1090/860/1990+ 1090/860/1990	1090/860/1990+ 1090/860/1990	1090/860/1990+ 1090/860/1990	1090/860/1990+ 1090/860/1990	1490/860/1990+ 1490/860/1990	1490/860/1990+ 1490/860/1990	1490/860/1990+ 1490/860/1990	
	Net/Shipping weight	kg	240/268	240/268	368/393	368/393	368/393	480/536	480/536	608/661	608/641		608/641	736/786	736/786	736/786	848/929	848/929	976/1054	976/1054	976/1054	1104/1179	1104/1179	1104/1179	
	Compressor type		DC INV SCROLL	DC INV SCROLL	DC INV SCROLL	DC INV SCROLL	DC INV SCROLL	DC INV SCROLL	DC INV SCROLL	DC INV SCROLL	DC INV SCROLL		DC INV SCROLL	DC INV SCROLL	DC INV SCROLL	DC INV SCROLL	DC INV SCROLL	DC INV SCROLL	DC INV SCROLL	DC INV SCROLL	DC INV SCROLL	DC INV SCROLL	DC INV SCROLL	DC INV SCROLL	DC INV SCROLL
	Compressor brand		MITSUBISHI ELECTRIC	MITSUBISHI ELECTRIC	MITSUBISHI ELECTRIC	MITSUBISHI ELECTRIC	MITSUBISHI ELECTRIC	MITSUBISHI ELECTRIC	MITSUBISHI ELECTRIC	MITSUBISHI ELECTRIC	MITSUBISHI ELECTRIC		MITSUBISHI ELECTRIC	MITSUBISHI ELECTRIC	MITSUBISHI ELECTRIC	MITSUBISHI ELECTRIC	MITSUBISHI ELECTRIC	MITSUBISHI ELECTRIC	MITSUBISHI ELECTRIC	MITSUBISHI ELECTRIC	MITSUBISHI ELECTRIC	MITSUBISHI ELECTRIC	MITSUBISHI ELECTRIC	MITSUBISHI ELECTRIC	
	Compressor quantity		1 INV	1 INV	1 INV+1 FIX	1 INV+1 FIX	1 INV+1 FIX	1 INV+1 INV	1 INV+1 INV	(1 INV) +(1 INV+1 FIX)	(1 INV) +(1 INV+1 FIX)		(1 INV) +(1 INV+1 FIX)	(1 INV+1 FIX) +(1 INV+1 FIX)	(1 INV+1 FIX) +(1 INV+1 FIX)	(1 INV+1 FIX) +(1 INV+1 FIX)	1 INV +1 INV +(1 INV+1 FIX)	1 INV +1 INV +(1 INV+1 FIX)	1 INV +(1 INV+1 FIX) +(1 INV+1 FIX)	1 INV +(1 INV+1 FIX) +(1 INV+1 FIX)	1 INV +(1 INV+1 FIX) +(1 INV+1 FIX)	(1 INV+1 FIX) +(1 INV+1 FIX) +(1 INV+1 FIX)	(1 INV+1 FIX) +(1 INV+1 FIX) +(1 INV+1 FIX)	(1 INV+1 FIX) +(1 INV+1 FIX) +(1 INV+1 FIX)	
	Refrigerant type		R410A	R410A	R410A	R410A	R410A	R410A	R410A	R410A	R410A		R410A	R410A	R410A	R410A	R410A	R410A	R410A	R410A	R410A	R410A	R410A	R410A	R410A
	Refrigerant charge	kg	10	10	10	10	10	20	20	20	20		20	20	20	20	30	30	30	30	30	30	30	30	30
	Refrigerant liquid pipe	mm	9.52	9.52	12.7	12.7	12.7	15.88	15.88	15.88	15.88		19.05	19.05	19.05	19.05	19.05	19.05	19.05	19.05	19.05	19.05	19.05	19.05	19.05
	Refrigerant gas pipe	mm	19.05	22.22	25.4	25.4	28.58	28.58	28.58	28.58	28.58		31.8	31.8	31.8	31.8	34.9	34.9	38.1	38.1	38.1	38.1	38.1	38.1	38.1
	Gas pipe	mm	19.05	19.05	22.22	22.22	22.22	25.4	25.4	25.4	25.4		28.58	28.58	28.58	28.58	28.58	28.58	31.8	31.8	31.8	31.8	31.8	31.8	31.8
	Oil equalization pipe	mm	9.52	9.52	9.52	9.52	9.52	9.52	9.52	9.52	9.52		9.52	9.52	9.52	9.52	9.52	9.52	9.52	9.52	9.52	9.52	9.52	9.52	9.52
	Total pipe length	m	300	300	300	300	300	300	300	300	300		300	300	300	300	300	300	300	300	300	300	300	300	300
	Max. pipe length (Equivalent/Actual)	m	175/150	175/150	175/150	175/150	175/150	175/150	175/150	175/150	175/150		175/150	175/150	175/150	175/150	175/150	175/150	175/150	175/150	175/150	175/150	175/150	175/150	175/150
	Max drop between I.U.&O.U	m	50/40	50/40	50/40	50/40	50/40	50/40	50/40	50/40	50/40		50/40	50/40	50/40	50/40	50/40	50/40	50/40	50/40	50/40	50/40	50/40	50/40	50/40
External static pressure	Pa	50	50	50	50	50	50	50	50	50		50	50	50	50	50	50	50	50	50	50	50	50	50	
Connection ratio	Connectable indoor unit ratio	%	50-130	50-130	50-130	50-130	50-130	50-130	50-130	50-130		50-130	50-130	50-130	50-130	50-130	50-130	50-130	50-130	50-130	50-130	50-130	50-130	50-130	
	Maximum number of indoor units		13	16	19	23	26	29	33	36	39		43	46	50	53	56	59	63	64	64	64	64	64	
Working temp.	Cooling	°C	-5-43	-5-43	-5-43	-5-43	-5-43	-5-43	-5-43	-5-43		-5-43	-5-43	-5-43	-5-43	-5-43	-5-43	-5-43	-5-43	-5-43	-5-43	-5-43	-5-43	-5-43	
	Heating	°C	-15-15.5	-15-15.5	-15-15.5	-15-15.5	-15-15.5	-15-15.5	-15-15.5	-15-15.5	-15-15.5		-15-15.5	-15-15.5	-15-15.5	-15-15.5	-15-15.5	-15-15.5	-15-15.5	-15-15.5	-15-15.5	-15-15.5	-15-15.5	-15-15.5	
	Cooling & Heating	°C	-8-18	-8-18	-8-18	-8-18	-8-18	-8-18	-8-18	-8-18	-8-18		-8-18	-8-18	-8-18	-8-18	-8-18	-8-18	-8-18	-8-18	-8-18	-8-18	-8-18	-8-18	

* 1 outdoor above 50m outdoor below 40m
 * All the specifications are tested under normal condition in cooling. Indoor temp is 27°C DB/19°C WB. Outdoor temp 35°C DB/24°C WB. In heating, Indoor temp is 20°C DB. Outdoor temp is 7°C DB/6°C WB.
 * The specification may change according to the further product development.

MRV III-RC (HEAT RECOVERY)



8/10HP



12/14/16HP



Power Supply: 3/208-230/50/60
 DC Inverter Scroll Compressor & BLDC Fan
 5 Basic Single Modular Units: 8HP, 10HP, 12HP, 14HP, 16HP
 Max. 3 Modules Combination up to 48HP,
 Max Connected Indoor Units up to 64.
 Compatible with all the MRV Indoor Units



Model		AV08CMVUSA	AV10CMVUSA	AV12CMVUSA	AV14CMVUSA	AV16CMVUSA	AV18CMVUSA	AV20CMVUSA	AV22CMVUSA	AV24CMVUSA		AV26CMVUSA	AV28CMVUSA	AV30CMVUSA	AV32CMVUSA	AV34CMVUSA	AV36CMVUSA	AV38CMVUSA	AV40CMVUSA	AV42CMVUSA	AV44CMVUSA	AV46CMVUSA	AV48CMVUSA		
Combination model		/	/	/	/	/	AV08CMVUSA	AV10CMVUSA	AV10CMVUSA	AV10CMVUSA		AV10CMVUSA	AV14CMVUSA	AV14CMVUSA	AV16CMVUSA	AV10CMVUSA	AV10CMVUSA	AV10CMVUSA	AV10CMVUSA	AV10CMVUSA	AV12CMVUSA	AV14CMVUSA	AV16CMVUSA		
		/	/	/	/	/	AV10CMVUSA	AV10CMVUSA	AV12CMVUSA	AV14CMVUSA		AV16CMVUSA	AV14CMVUSA	AV16CMVUSA	AV16CMVUSA	AV14CMVUSA	AV16CMVUSA	AV14CMVUSA	AV16CMVUSA	AV16CMVUSA	AV16CMVUSA	AV16CMVUSA	AV16CMVUSA		
Capacity	Capacity range	HP	8	10	12	14	16	18	20	22	24		26	28	30	32	34	36	38	40	42	44	46	48	
	Cooling	kW	22.4	28	33.5	40	45	50.4	56	61.5	68		73	80	85	90	96	101	106.5	113	118	123.5	130	135	
Electrical parameters	Heating	kW	25	31.5	37.5	45	50	56.5	63	69	76.5		81.5	90	95	100	108	113	119	126.5	131.5	137.5	145	150	
	Power supply	Ph/V/Hz	3/208-230/60	3/208-230/60	3/208-230/60	3/208-230/60	3/208-230/60	3/208-230/60	3/208-230/60	3/208-230/60	3/208-230/60		3/208-230/60	3/208-230/60	3/208-230/60	3/208-230/60	3/208-230/60	3/208-230/60	3/208-230/60	3/208-230/60	3/208-230/60	3/208-230/60	3/208-230/60	3/208-230/60	
	Cooling	Rated power input	kW	5.81	7.55	9.18	12.3	14.1	13.36	15.1	16.73	19.85		21.65	24.6	26.4	28.2	27.4	29.2	30.83	33.95	35.75	37.38	40.5	42.3
		Max power input	kW	12.5	14.5	16.5	18.5	20	27	29	31	33		34.5	37	38.5	40	47.5	49	51	53	54.5	56.5	58.5	60
		Rated current	A	16.40	21.31	25.91	34.71	39.79	37.70	42.61	47.21	56.02		61.09	69.42	74.50	79.58	77.32	82.40	87.00	95.80	100.88	105.48	114.29	119.37
		Max current	A	38.6	44.7	50.9	57.1	61.7	83.3	89.4	95.6	101.8		106.4	114.2	118.8	123.4	146.5	151.1	157.3	163.5	168.1	174.3	180.5	185.1
	Heating	Rated power input	kW	6.1	7.97	9.15	11.1	13.5	14.07	15.94	17.12	19.07		21.47	22.2	24.6	27	27.04	29.44	30.62	32.57	34.97	36.15	38.1	40.5
		Max power input	kW	12.5	14.5	16.5	18.5	20	27	29	31	33		34.5	37	38.5	40	47.5	49	51	53	54.5	56.5	58.5	60
		Rated current	A	17.21	22.49	25.82	31.32	38.10	39.70	44.98	48.31	53.81		60.59	62.65	69.42	76.19	76.31	83.08	86.41	91.91	98.68	102.01	107.52	114.29
		Max current	A	38.6	44.7	50.9	57.1	61.7	83.3	89.4	95.6	101.8		106.4	114.2	118.8	123.4	146.5	151.1	157.3	163.5	168.1	174.3	180.5	185.1
	EER		3.86	3.71	3.65	3.25	3.19	3.77	3.71	3.68	3.43		3.37	3.25	3.22	3.19	3.50	3.46	3.45	3.33	3.30	3.30	3.21	3.19	
	COP		4.10	3.95	4.10	4.05	3.70	4.02	3.95	4.03	4.01		3.80	4.05	3.86	3.70	3.99	3.84	3.89	3.88	3.76	3.80	3.81	3.70	
	Performance	Air flow (H)	m³/h	11100	11100	14100	14100	22200	22200	25200	25200		25200	28200	28200	28200	36300	36300	39300	39300	42300	42300	42300	42300	
		Sound pressure level (H)	dB(A)	57	57	60	60	60	60	61	61		61	62	62	62	63	63	63	63	63	64	64	64	64
		Sound power level (H)	dB(A)	73	73	76	76	76	77	77	78	78		78	79	79	79	81	81	81	81	81	82	82	82
	Installation	External dimensions (W/D/H)	mm	990/750/1808	990/750/1808	1390/750/1808	1390/750/1808	1390/750/1808	990/750/1808+ 990/750/1808	990/750/1808+ 990/750/1808	990/750/1808+ 1390/750/1808	990/750/1808+ 1390/750/1808		990/750/1808+ 1390/750/1808	1390/750/1808+ 1390/750/1808	1390/750/1808+ 1390/750/1808	1390/750/1808+ 1390/750/1808	990/750/1808+ 990/750/1808	990/750/1808+ 1390/750/1808	990/750/1808+ 1390/750/1808	990/750/1808+ 1390/750/1808	990/750/1808+ 1390/750/1808	1390/750/1808+ 1390/750/1808	1390/750/1808+ 1390/750/1808	1390/750/1808+ 1390/750/1808
Shipping dimensions (W/D/H)		mm	1090/860/1990	1090/860/1990	1490/860/1990	1490/860/1990	1490/860/1990	1090/860/1990+ 1090/860/1990	1090/860/1990+ 1090/860/1990	1090/860/1990+ 1490/860/1990	1090/860/1990+ 1490/860/1990		1090/860/1990+ 1490/860/1990	1490/860/1990+ 1490/860/1990	1490/860/1990+ 1490/860/1990	1490/860/1990+ 1490/860/1990	1090/860/1990+ 1090/860/1990	1090/860/1990+ 1490/860/1990	1090/860/1990+ 1490/860/1990	1090/860/1990+ 1490/860/1990	1090/860/1990+ 1490/860/1990	1490/860/1990+ 1490/860/1990	1490/860/1990+ 1490/860/1990	1490/860/1990+ 1490/860/1990	
Net/Shipping weight		kg	240/268	240/268	368/393	368/393	368/393	480/536	480/536	608/661	608/641		608/641	736/786	736/786	736/786	848/929	848/929	976/1054	976/1054	976/1054	1104/1179	1104/1179	1104/1179	
Compressor type			DC INV SCROLL	DC INV SCROLL	DC INV SCROLL	DC INV SCROLL	DC INV SCROLL	DC INV SCROLL	DC INV SCROLL	DC INV SCROLL	DC INV SCROLL		DC INV SCROLL	DC INV SCROLL	DC INV SCROLL	DC INV SCROLL	DC INV SCROLL	DC INV SCROLL	DC INV SCROLL	DC INV SCROLL	DC INV SCROLL	DC INV SCROLL	DC INV SCROLL	DC INV SCROLL	
Compressor brand			MITSUBISHI ELECTRIC	MITSUBISHI ELECTRIC	MITSUBISHI ELECTRIC	MITSUBISHI ELECTRIC	MITSUBISHI ELECTRIC	MITSUBISHI ELECTRIC	MITSUBISHI ELECTRIC	MITSUBISHI ELECTRIC	MITSUBISHI ELECTRIC		MITSUBISHI ELECTRIC	MITSUBISHI ELECTRIC	MITSUBISHI ELECTRIC	MITSUBISHI ELECTRIC	MITSUBISHI ELECTRIC	MITSUBISHI ELECTRIC	MITSUBISHI ELECTRIC	MITSUBISHI ELECTRIC	MITSUBISHI ELECTRIC	MITSUBISHI ELECTRIC	MITSUBISHI ELECTRIC	MITSUBISHI ELECTRIC	
Compressor quantity			1 INV	1 INV	1 INV+1 FIX	1 INV+1 FIX	1 INV+1 FIX	1 INV+1 INV	1 INV+1 INV	(1 INV) +(1 INV+1 FIX)	(1 INV) +(1 INV+1 FIX)		(1 INV) +(1 INV+1 FIX)	(1 INV+1 FIX) +(1 INV+1 FIX)	(1 INV+1 FIX) +(1 INV+1 FIX)	(1 INV+1 FIX) +(1 INV+1 FIX)	1 INV +1 INV	1 INV +1 INV	1 INV +(1 INV+1 FIX)	1 INV +(1 INV+1 FIX)	1 INV +(1 INV+1 FIX)	1 INV +(1 INV+1 FIX)	(1 INV+1 FIX) +(1 INV+1 FIX)	(1 INV+1 FIX) +(1 INV+1 FIX)	
Refrigerant type			R410A	R410A	R410A	R410A	R410A	R410A	R410A	R410A	R410A		R410A	R410A	R410A	R410A	R410A	R410A	R410A	R410A	R410A	R410A	R410A	R410A	
Refrigerant charge		kg	10	10	10	10	10	20	20	20	20		20	20	20	30	30	30	30	30	30	30	30	30	
Refrigerant liquid pipe		mm	9.52	9.52	12.70	12.70	12.70	15.88	15.88	15.88	15.88		19.05	19.05	19.05	19.05	19.05	19.05	19.05	19.05	19.05	19.05	19.05	19.05	
Refrigerant gas pipe		mm	19.05	22.22	25.40	25.40	28.58	28.58	28.58	28.58	28.58		31.80	31.80	31.80	31.80	34.90	34.90	38.10	38.10	38.10	38.10	38.10	38.10	
Gas pipe		mm	19.05	19.05	22.22	22.22	22.22	25.40	25.40	25.40	25.40		28.58	28.58	28.58	28.58	28.58	28.58	31.80	31.80	31.80	31.80	31.80	31.80	
Oil equalization pipe		mm	9.52	9.52	9.52	9.52	9.52	9.52	9.52	9.52	9.52		9.52	9.52	9.52	9.52	9.52	9.52	9.52	9.52	9.52	9.52	9.52	9.52	
Total pipe length		m	300	300	300	300	300	300	300	300	300		300	300	300	300	300	300	300	300	300	300	300	300	
Max pipe length (Equivalent/Actual)		m	175/150	175/150	175/150	175/150	175/150	175/150	175/150	175/150	175/150		175/150	175/150	175/150	175/150	175/150	175/150	175/150	175/150	175/150	175/150	175/150	175/150	
Max drop between I.U.&O.U		m	50/40	50/40	50/40	50/40	50/40	50/40	50/40	50/40	50/40		50/40	50/40	50/40	50/40	50/40	50/40	50/40	50/40	50/40	50/40	50/40	50/40	
External static pressure		Pa	50	50	50	50	50	50	50	50	50		50	50	50	50	50	50	50	50	50	50	50	50	
Connection ratio	Connectable indoor unit ratio	%	50-130	50-130	50-130	50-130	50-130	50-130	50-130	50-130		50-130	50-130	50-130	50-130	50-130	50-130	50-130	50-130	50-130	50-130	50-130	50-130		
	Maximum number of indoor units		13	16	19	23	26	29	33	36		43	46	50	53	56	59	63	64	64	64	64	64		
Working temp.	Cooling	°C	-5-43	-5-43	-5-43	-5-43	-5-43	-5-43	-5-43	-5-43		-5-43	-5-43	-5-43	-5-43	-5-43	-5-43	-5-43	-5-43	-5-43	-5-43	-5-43	-5-43		
	Heating	°C	-15-15.5	-15-15.5	-15-15.5	-15-15.5	-15-15.5	-15-15.5	-15-15.5	-15-15.5	-15-15.5		-15-15.5	-15-15.5	-15-15.5	-15-15.5	-15-15.5	-15-15.5	-15-15.5	-15-15.5	-15-15.5	-15-15.5	-15-15.5	-15-15.5	
	Cooling & Heating	°C	-8-18	-8-18	-8-18	-8-18	-8-18	-8-18	-8-18	-8-18	-8-18		-8-18	-8-18	-8-18	-8-18	-8-18	-8-18	-8-18	-8-18	-8-18	-8-18	-8-18	-8-18	

* 1 outdoor above 50m outdoor below 40m.
 * All the specifications are tested under normal condition in cooling. Indoor temp is 27°C DB/19°C WB. Outdoor temp 35°C DB/24°C WB. In heating. Indoor temp is 20°C DB. Outdoor temp is 7°C DB/6°C WB.
 * The specification may change according to the further product development.

MRV V-C
 MRV III-C
 MRV III-RC
 MRV S
 MRV W
 Easy MRV
 MRV AHU
 MRV Indoor
 Control System
 Reference Projects



- | 067 Features & Benefits
- | 075 MRV S¹Outdoor
- | 080 MRV S¹Outdoor

MRV S^{II} (4/5/6HP)

New platform, new outlook

Spiral air outlet grill
Better outlook and lower noise

Built-in stop valve
Better outlook and easier to install

Round corner
Better outlook & safer



High energy efficiency

- 1 DC inverter compressor**
Haier takes DC INV. compressor, 5% power input lower. (14kw)
- 2 DC fan motor and 550mm big fan**
38% power input lower and 8% airflow higher
- 3 Larger heat exchanger**
Heat exchange area rise 10% . (14kw)
- 4 Ball valve**
0 pressure loss when refrigerant goes through the valve .
capacity rise 0.5% with same power input
- 5 Low standby power**
New PCB programme , reduce 20% standby power consumption

Comfort

- 6 New aerodynamics fan**
550mm super big diameter aerospace helix fan.
lowering sound level 3 dB(A)
- 7 Enlarged air inlet path and spiral air outlet path**
Air flow direction follows the grill direction .
lowering sound level 2-4 dB(A)
- 8 Automatic sound-lowering programme**
Night mode set by PCB, 8dB(A) lower

Convenience

- 9 Double side "4" handles**
Easy to carry
- 10 "888" test panel**
All running data & error code can be checked from "888" screen, which is easy for installers
- 11 "Four-way" pipe connection**
4-way (front,back,left & right) pipe connection,
easy to design and install



MRV S^{II} (8/10/12HP)

Outdoor Structure (8/10/12HP Side Discharge)

Bigger Outdoor Capacity, More Flexible Application



- Twin rotary DC Inverter compressor**
 - High chamber DC INVERTER twin rotary compressor
 - Small vibration, low noise, high energy efficiency
- Double pressure sensor**
 - Equipped with high and low voltage Pressure double sensors
 - Accurate Pressure control, the system run more smoothly, more energy efficiency
- Large diameter fan**
 - 570mm big diameter axial flow fan
 - Zigzag design, reduce airflow disturbance, air volume is bigger, the noise is lower
- High efficiency condenser**
 - New type high efficiency Ø8 inner grooved tube
 - New hydrophilic corrugated fissure fin, high efficiency
- Vector inverter control**
 - 180 degrees sine wave vector control, 64-bit operation
 - High precision control, to achieve high efficiency and lower noise
- High efficiency DC fan motor**
 - DC fan motor with stepless inverter control, efficiency increase 45% comparing with AC motor and power input largely decrease



- 1 Energy Efficiency
- 2 Comfort Environment
- 3 Side Discharge and Compact Design
- 4 High Reliability

High EER and COP

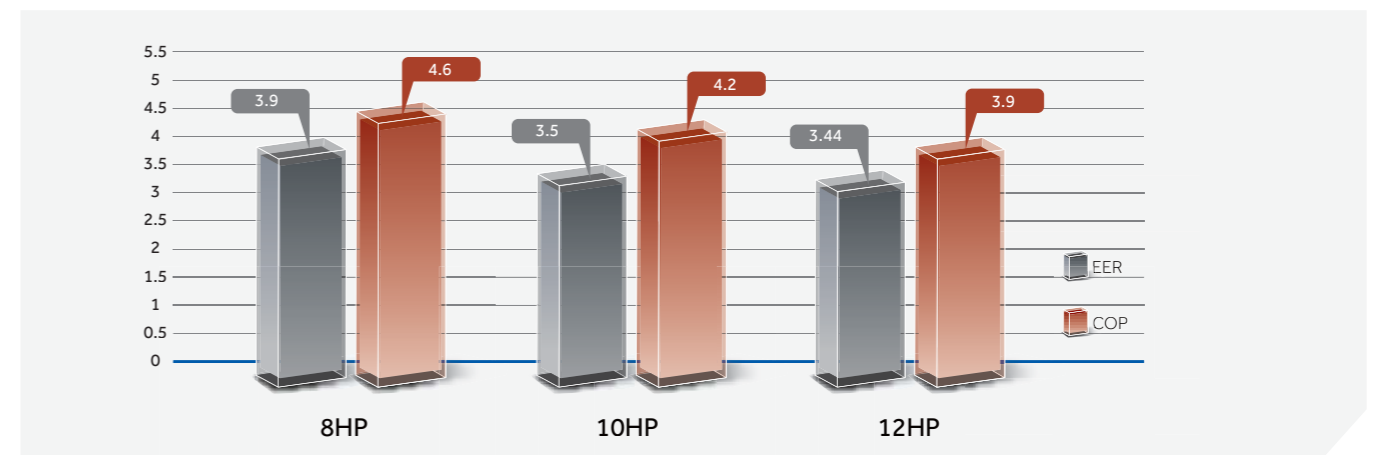

DC Fan and Fan Motor

DC inverter fan motor more higher efficiency in part load running

- 16-stage speed control; high efficiency running especially in low speed
- Efficiency increase 45% comparing with AC motor and power input largely decrease

Big diameter fan

- 570mm big diameter fan, more big air flow and more higher efficiency

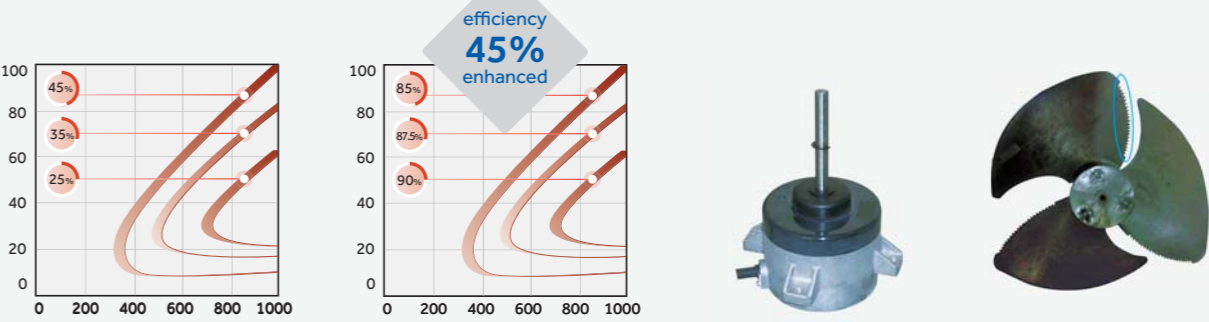

efficiency 45% enhanced

AC motor efficiency vs DC motor efficiency comparison graphs showing efficiency levels of 25%, 35%, 45%, 85%, 87.5%, and 90%.

DC motor and Ø570mm fan images.

MRV S^{II}

MRV S^{II} (8/10/12HP)

Energy Efficiency

Low noise level

Night Quiet Operation Function

Noise can be reduced to 45dB(A)

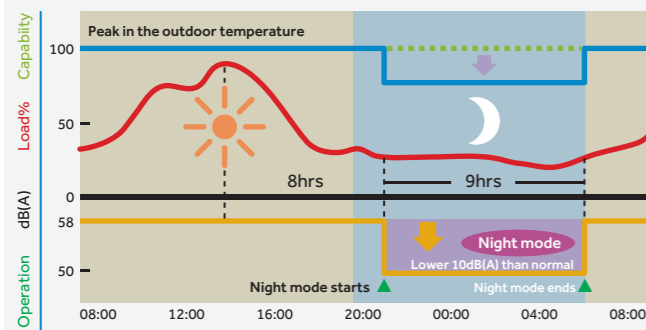

Low noise operation

- DC INVERTER compressor, smooth operation, no need frequent start the compressor, effectively reduce the noise outdoor
- Vector inverter control, more precise control
- DC fan motor, motor bracket used the non-resonance structure, ensure smooth running of the motor, reduce operating noise
- Big diameter fan, design according to aviation quieter principle



Easy installation

Compact Side Discharge Design, Big Capacity, Small Floor Area

Small floor area, only 0.42m², 43% floor area can be reduced

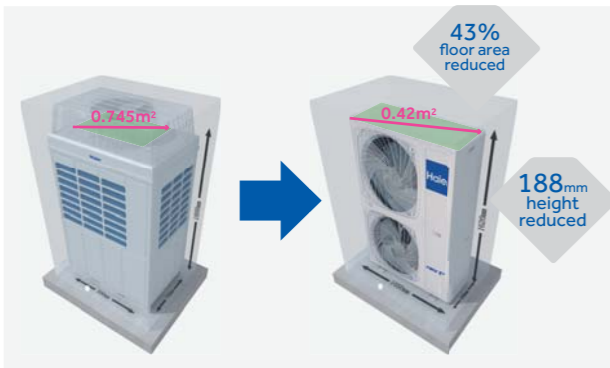

Compact Side Discharge Design

No need additional ventilation hood comparing with top discharge unit

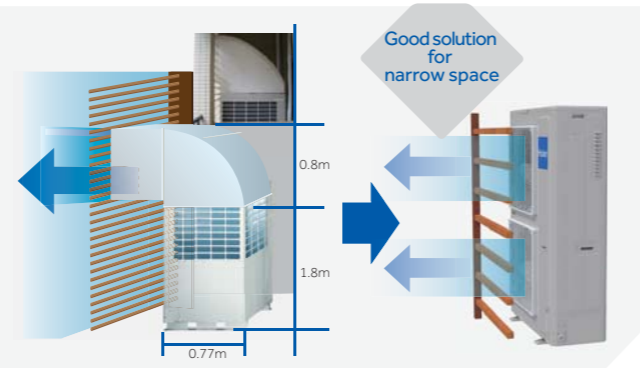

Easy installation

4 Way pipe connection

Front, rear, right, down 4 way pipe connection, flexible installation



New DC inverter twin rotary compressor

- Small torque change, good dynamic balance, the system runs stably, little vibration, low noise, high efficiency
- More higher efficiency in part load running

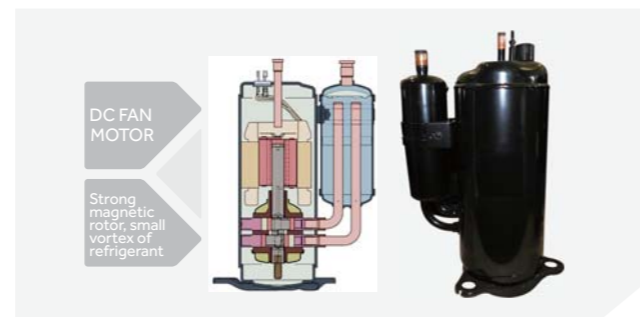

Easy Installation

Long pipe length, high height drop

- Total pipe length: 300m
- Single pipe length: Max.175m
- From outdoor to the first branch pipe: 135m
- From the first branch to the farthest indoor door unit: 40m
- Height drop: 50m(outdoor above)/40m(outdoor below)
- Height drop between indoor units: 15m

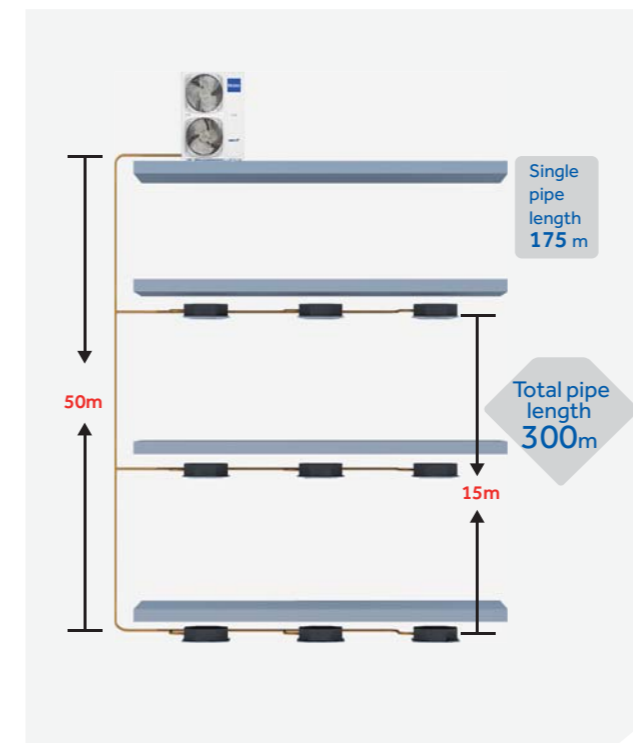

Separate refrigerant charging valve

Easy for refrigerant charging

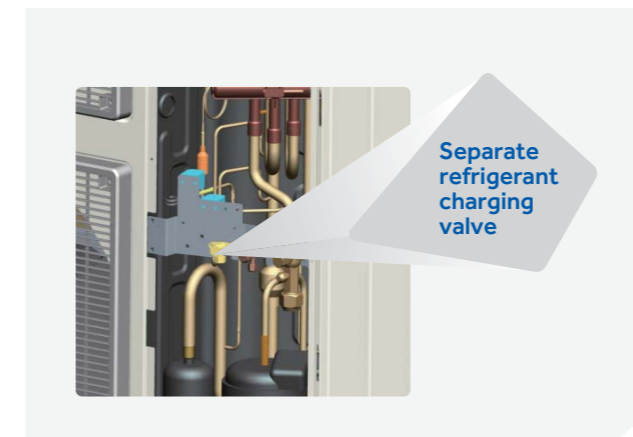

Easy Service

Parameter display panel

- The first original parameter display panel on the side
- The parameter can be observed directly by opening the protective cover in case of maintenance, to avoid removing the repair board

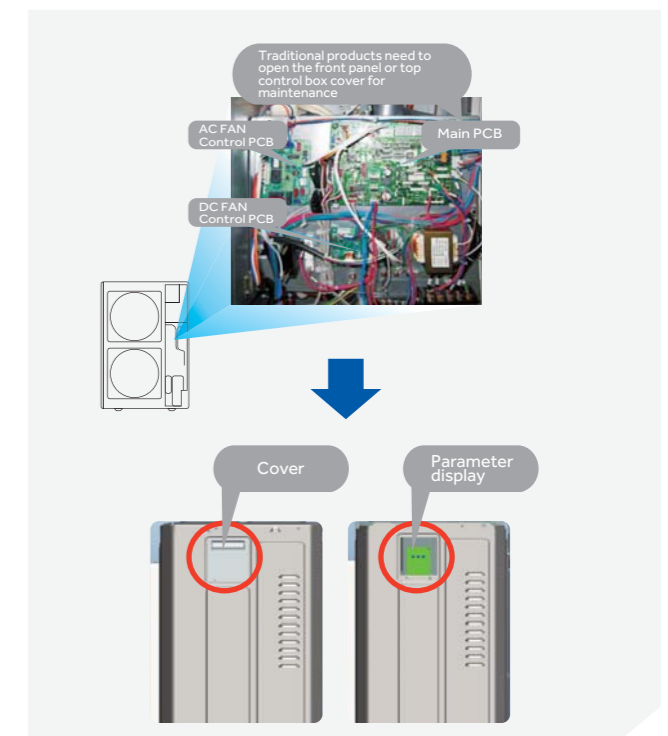

Easy maintenance for control

- The control box is in front, reserving space 108mm between control box and top panel, easy maintenance from the top
- Control box is with hinge design, easy to open for maintenance

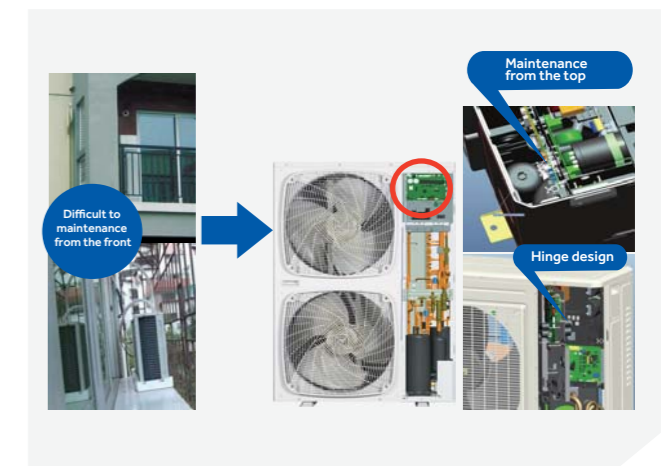

FEATURES & BENEFITS

High Reliability

Refrigerant automatically reclaim Technology

•Set refrigerant automatically reclaim through dip switch, the refrigerant in indoor and pipe can be automatically return to outdoor, convenient in maintenance and reducing waste of refrigerant, reduce customer maintenance cost, improve the efficiency of after-sales maintenance

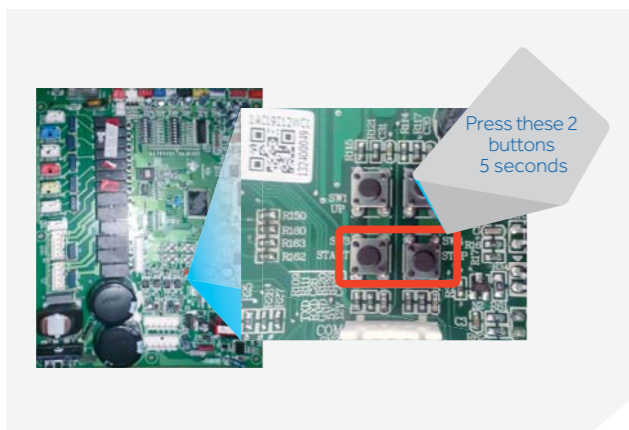

Refrigerant control technology

•Refrigerant control technology without high pressure accumulator, reducing the refrigerant volume and enhancing the running efficiency

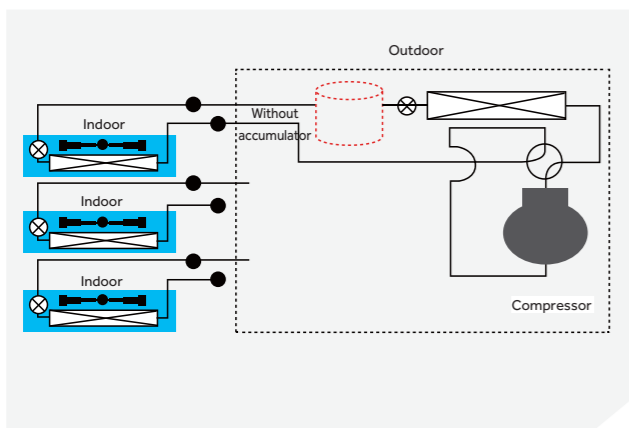

High Reliability

Air inlet grill design on right side panel

•Air inlet grill design, reducing the module temperature and avoid air dust into air conditioner

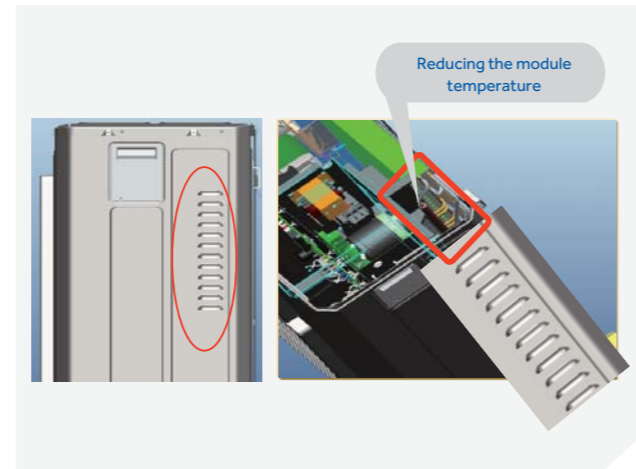



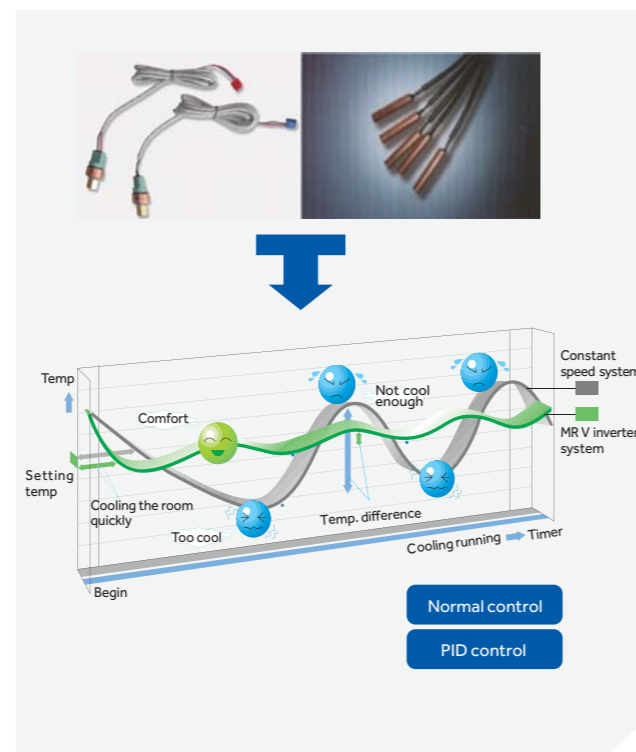

High and low double pressure sensor

•Double pressure sensor with PID control technology
•Together with high speed communication to realize the quick start of compressor and more precise control, the temperature can be control $\pm 0.5^{\circ}\text{C}$



MRV S^{II} OUTDOOR



-  AU042FPERA
-  AU052FPERA
-  AU051FPERA
-  AU061FPERA



Model			AU042FPERA	AU052FPERA	AU051FPERA	AU061FPERA
Capacity	Capacity range	HP	4	5	5	6
	Cooling	kBtu/h	43	47.8	47.8	52.9
		kW	12.6	14	14	15.5
Heating	kBtu/h	48.4	54.6	54.6	61.4	
	kW	14.2	16	16	18	
Electrical parameters	Power supply	PhV/Hz	1/220-230/50/60	1/220-230/50/60	3/380-400/50/60	3/380-400/50/60
	Power input (Cooling)	kW	3.41	3.84	3.90	4.89
	Power input (Heating)	kW	3.40	4.12	4.19	5.04
	EER/COP		3.70	3.65	3.59	3.17
Performance	Air flow (H)	m ³ /h	4.18	3.88	3.82	3.57
	Sound pressure level (H)	dB(A)	7200	7200	7200	7200
	Sound power level (H)	dB(A)	50	51	51	53
Installation	External dimensions(W/D/H)	mm	66	67	67	69
	Shipping dimensions(W/D/H)	mm	950/370/1340	950/370/1340	950/370/1340	950/370/1340
	Net/Shipping weight	kg	1023/471/1420	1023/471/1420	1023/471/1420	1023/471/1420
	Compressor type		115/123	115/123	115/123	115/123
	Compressor brand		Rotary	Rotary	Rotary	Rotary
			MITSUBISHI ELECTRIC	MITSUBISHI ELECTRIC	MITSUBISHI ELECTRIC	MITSUBISHI ELECTRIC
	Compressor quantity		1	1	1	1
	Refrigerant type		R410A	R410A	R410A	R410A
	Refrigerant charge	kg	4	4	4	4
	Refrigerant liquid pipe	mm	9.52	9.52	9.52	9.52
	Refrigerant gas pipe	mm	15.88	15.88	15.88	15.88
	Total pipe length	m	300	300	300	300
Max. pipe length(Equivalent/Actual)	m	150	150	150	150	
Max drop between I.U.&O.U.	m	50	50	50	50	
Connection ratio	Connectable indoor unit ratio	%	50-130	50-130	50-130	50-130
	Maximum number of indoor units		7	10	10	12
Working temp.	Cooling	°C	-15-48	-15-48	-15-48	-15-48
	Heating	°C	-20-27	-20-27	-20-27	-20-27

* Models are under development, data is pending.

MRV S^{II} OUTDOOR

-  AV08NMSETA
-  AV10NMSETA
-  AV12NMSETA



Model			AV08NMSETA	AV10NMSETA	AV12NMSETA
Capacity	Capacity range	HP	8	10	12
	Cooling	kBtu/h	77.1	95.5	114.3
		kW	22.6	28	33.5
Heating	kBtu/h	85.3	107.5	128	
	kW	25	31.5	37.5	
Electrical parameters	Power supply	PhV/Hz	3/380-400/50/60	3/380-400/50/60	3/380-400/50/60
	Power input (Cooling)	kW	5.79	8	9.75
	Power input (Heating)	kW	5.43	7.5	9.62
	EER/COP		3.9/4.6	3.5/4.2	3.44/3.9
Performance	Air flow (H)	m ³ /h	10000	10000	10000
	Sound pressure level (H)	dB(A)	55	58	60
	Sound power level (H)	dB(A)	66	69	71
Installation	External dimensions(W/D/H)	mm	1050/400/1636	1050/400/1636	1050/400/1636
	Shipping dimensions(W/D/H)	mm	1150/510/1795	1150/510/1795	1150/510/1795
	Net/Shipping weight	kg	168/183	168/183	168/183
	Compressor type		Rotary	Rotary	Rotary
	Compressor brand		MITSUBISHI ELECTRIC	MITSUBISHI ELECTRIC	MITSUBISHI ELECTRIC
	Compressor quantity		1 INV	1 INV	1 INV
	Refrigerant type		R410A	R410A	R410A
	Refrigerant charge	kg	7.4	7.4	7.4
	Refrigerant liquid pipe	mm	9.52	12.7	12.7
	Refrigerant gas pipe	mm	19.05	22.22	25.4
	Total pipe length	m	300	300	300
	Max. pipe length(Equivalent/Actual)	m	175/135	175/135	175/135
Max drop between I.U.&O.U.	m	50	50	50	
Connection ratio	Connectable indoor unit ratio	%	50-130	50-130	50-130
	Maximum number of indoor units		13	16	19
Working temp.	Cooling	°C	-5-43	-5-43	-5-43
	Heating	°C	-15-21	-15-21	-15-21

* All the specifications are tested under nominal condition. In cooling, indoor temp is 27°C DB/19°C WB, Outdoor temp 35°C DB/24°C WB. In heating, indoor temp is 20°C DB, Outdoor temp is 7°C DB/6°C WB.



MRV S¹ (3/5/7HP)

DC Inverter Twin Rotary Compressor

Realize high efficiency and compact designed compressor by joint wrap & earths metal magnet motor.

Wide range inverter compressors would satisfy the customer's innovative requirement and design.



DC Inverter Twin Rotary Compressor



DC Inverter Technology

DC inverter motor

•DC fan motor speed can be adjusted from 0-1000 r/min, it can improve the unit efficiency, at the same time, the unit can realize low ambient cooling operation.

Ferrite Magnet **Neodymium Magnet**

High efficiency
Low vibration, low noise
High reliability

Operation Range

•MRV S¹ series permits a system design considering a heating range operation under a low temperature condition from -15°C of previous model and a cooling range operation -5°C.

•For the capacities under low temperature conditions, please see technical data sheets.

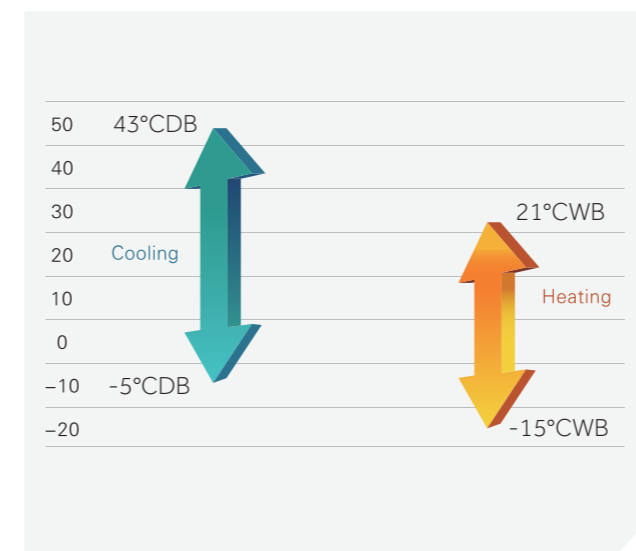

Precise Control

•PID control adjusts the output of compressor and the open degree of EEV, balances the indoor refrigerant flow, realizes the linear output, creates a comfortable environment. The temperature could be controlled precisely.

P : Proportion adjustment
I : Integral adjustment
D : Differential adjustment

Refrigerant flow speed vs Time

Refrigerant flow speed vs Time

Indoor temperature vs Time

Cooling

MRVIII (PID control)
Conventional control

Temp

Setting temp

Begin

Cooling the room quickly

Too cool

Temp. difference

Not cool enough

Cooling running

Timer

Constant speed system

MR V inverter system

MRV S¹

MRV S^I 3/5/7HP

180° Vector Control Technology

•Haier using power resistance to detect the rotor position of compressor, results in the consistency of the compressor working current and current sine waves, improve power efficiency about 17%.

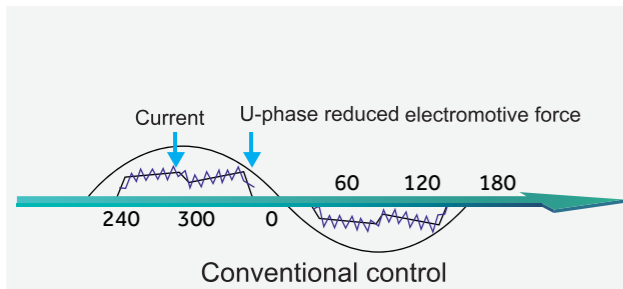

Side Discharge MRV S^I Outdoor Units

•Dual Frequency 50/60Hz
DC Inverter TWIN Rotary Compressor
BLDC Fan (BrushLess DC motor)



15kW 1 Phase
15kW 3 Phase
18kW 3 Phase



- 1 Control the compressor running frequency by temp. Sensor, more precise and prompt than conventional control system.
- 1 Protections: Pressure, temp., compressor, fan motor, refrigerant, oil quantity etc. Realize perfect performance.
- 1 Malfunction self-diagnose.
- 2 DC fan motor (AU48/60).
- 3 DC inverter compressor, high efficiency.
- 4 Single set valve, easy to installation and save installation time.

MRV S^I OUTDOOR

AU282FHERA

AU482FIERA(G)
AU48NFIERA(G)
AU60NFIERA(G)



Model		AU282FHERA	AU482FIERA(G)	AU48NFIERA(G)	AU60NFIERA(G)	
Capacity	Capacity range	HP	3HP	5HP	5HP	7HP
	Cooling	kBtu/h	27.3	51.2	51.2	61.4
		kW	8	15	15	18
Heating	kBtu/h	32.4	58	58	68.2	
	kW	9.5	17	17	20	
Electrical parameters	Power supply	PhV/Hz	1/220-230/50	1/220-230/50/60	3/380-400/50/60	3/380-400/50/60
	Power input (Cooling)	kW	2.2	4.2	4.2	5.5
	Power input (Heating)	kW	2.15	4	4	5.25
	EER/COP		3.64/4.42	3.57/4.25	3.57/4.25	3.27/3.8
Performance	Air flow (H)	m ³ /h	3500	6500	6500	6500
	Sound pressure level (H)	dB(A)	55	59	59	60
	Sound power level (H)	dB(A)	66	70	70	71
Installation	External dimensions(W/D/H)	mm	960/340/830	960/340/1250	960/340/1250	960/340/1250
	Shipping dimensions(W/D/H)	mm	1095/410/945	1095/410/1400	1095/410/1400	1095/410/1400
	Net/Shipping weight	kg	74/89	105/113	105/113	105/113
	Compressor type		Rotary	Rotary	Rotary	Rotary
	Compressor brand		MITSUBISHI ELECTRIC	MITSUBISHI ELECTRIC	MITSUBISHI ELECTRIC	MITSUBISHI ELECTRIC
	Compressor quantity		1 INV	1 INV	1 INV	1 INV
	Refrigerant type		R410A	R410A	R410A	R410A
	Refrigerant charge	kg	2.6	3.6	4	4
	Refrigerant liquid pipe	mm	9.52	9.52	9.52	9.52
	Refrigerant gas pipe	mm	15.88	19.05	19.05	19.05
Total pipe length	m	50	100	100	100	
Max pipe length(Equivalent/Actual)	m	35	70	70	70	
Max drop between I.U.&O.U	m	30	30	30	30	
Connectable indoor unit ratio	%	50-130	50-130	50-130	50-130	
Connection ratio	Maximum number of indoor units		4	8	8	9
	Cooling	°C	10-43	-5-43	-5-43	-5-43
Working temp.	Heating	°C	-15-21	-15-21	-15-21	-15-21

* All the specifications are tested under nominal condition in cooling, indoor temp is 27°C DB/19°C WB, Outdoor temp 35°C DB/24°C WB. In heating, indoor temp is 20°C DB, Outdoor temp is 7°C DB/6°C WB.





MRV W

| 083 Features & Benefits

| 097 MRV W Outdoor

MRV W

MRV W

FEATURES & BENEFITS

Outdoor Structure (8/10/12hp Side Discharge)

More Bigger Outdoor Capacity, More Flexible Application

River water **Lake water**

Sea water **Ground water**

Soil **Solar energy**

Waste water **Industry waste heat**

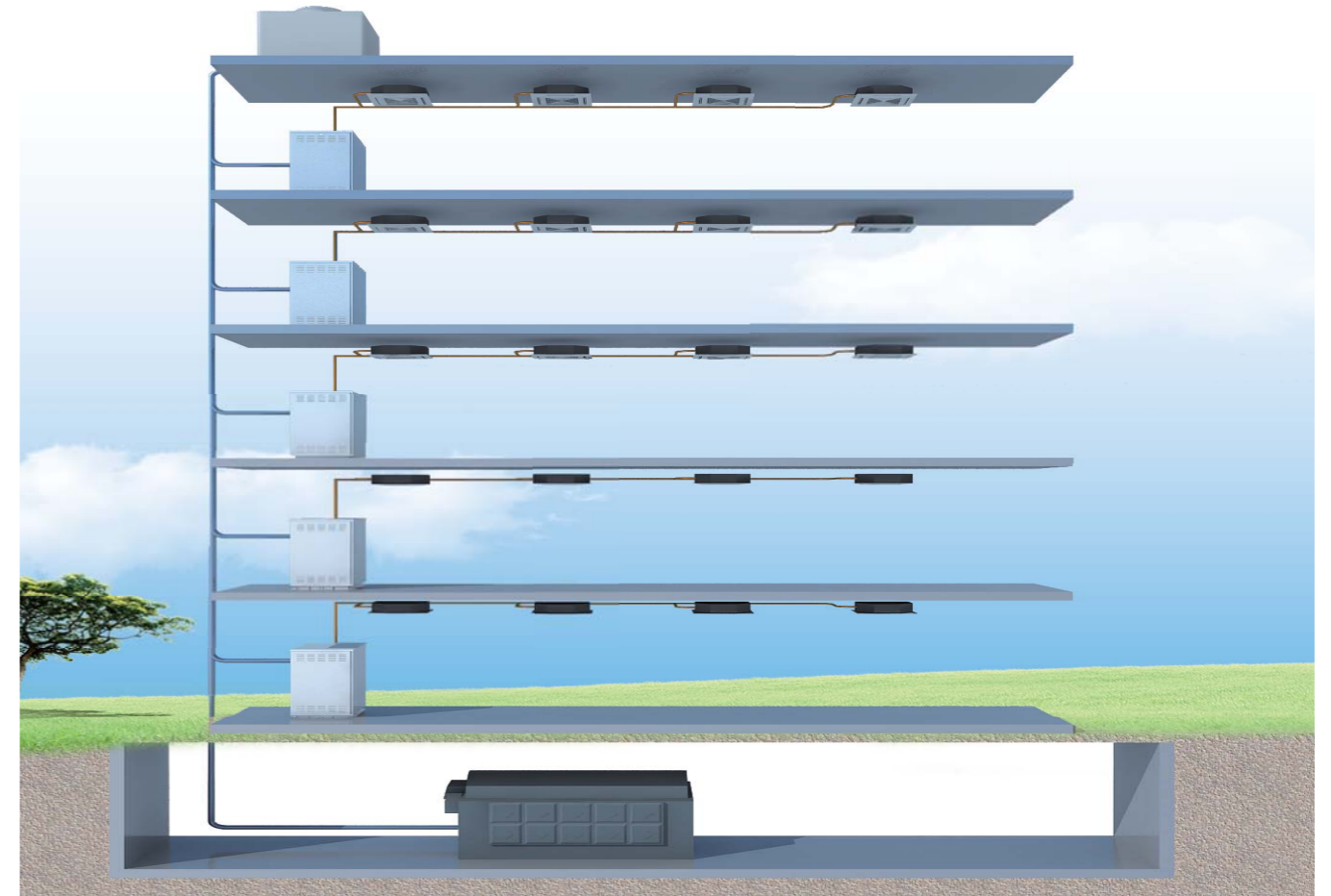

What is MRV W Series

- MRV W series system is a VRF air conditioning system that adopts water as a cooling or heating source
- MRV W series can combine water system and refrigerant system together

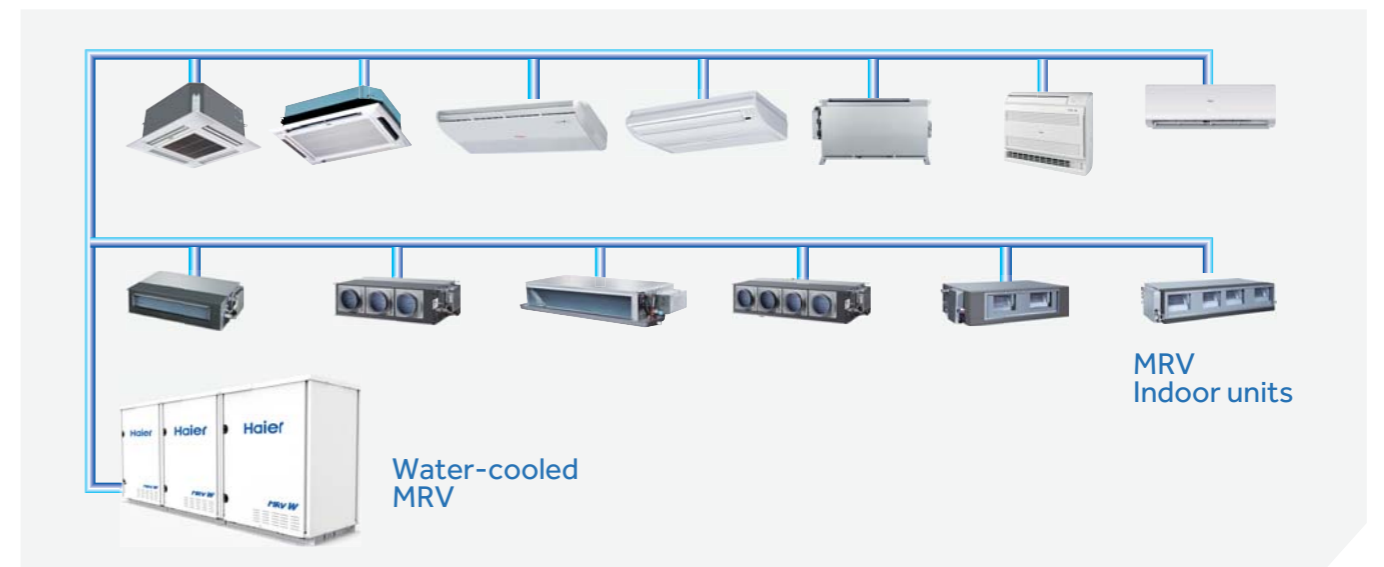

FEATURES & BENEFITS

System Introduction

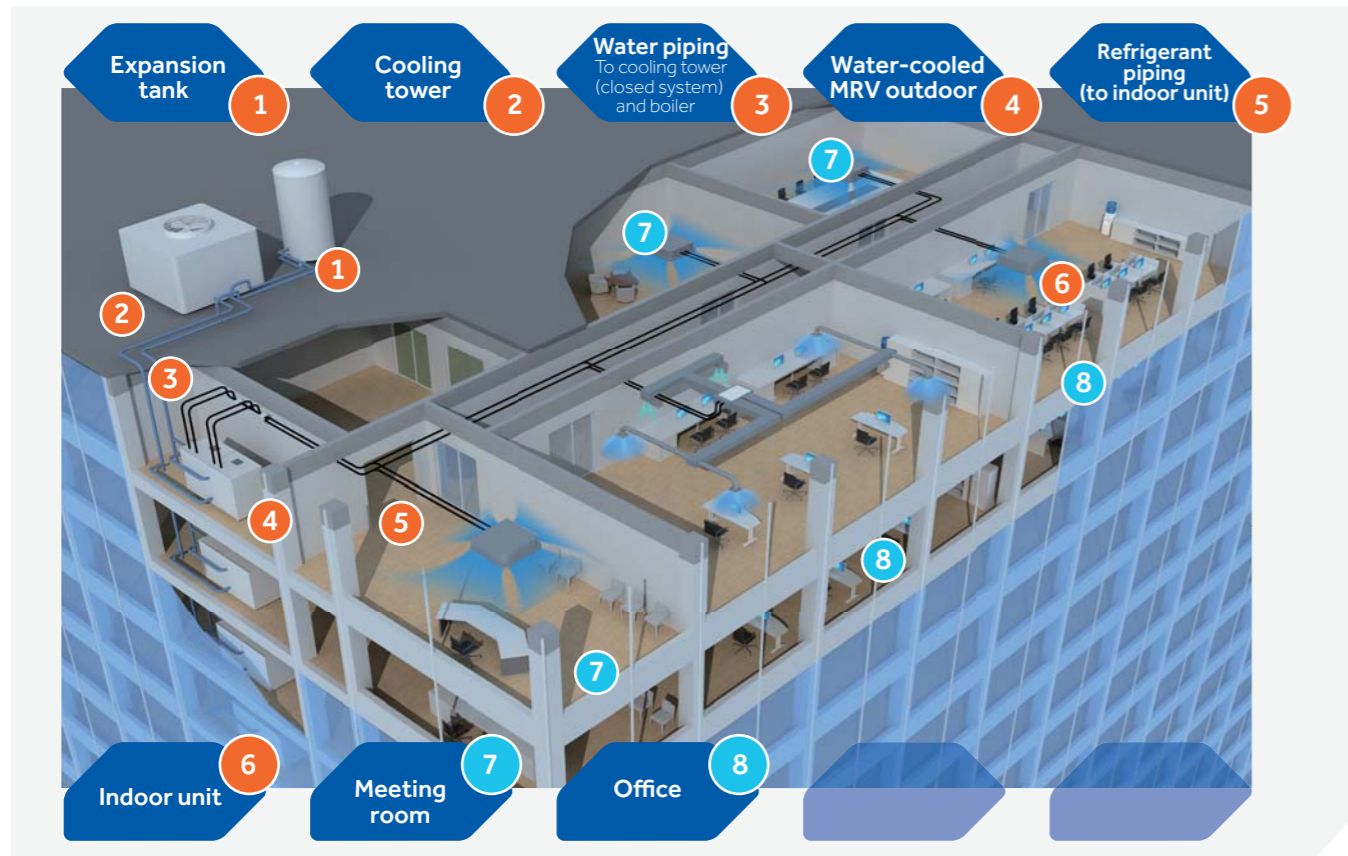

Working Principle

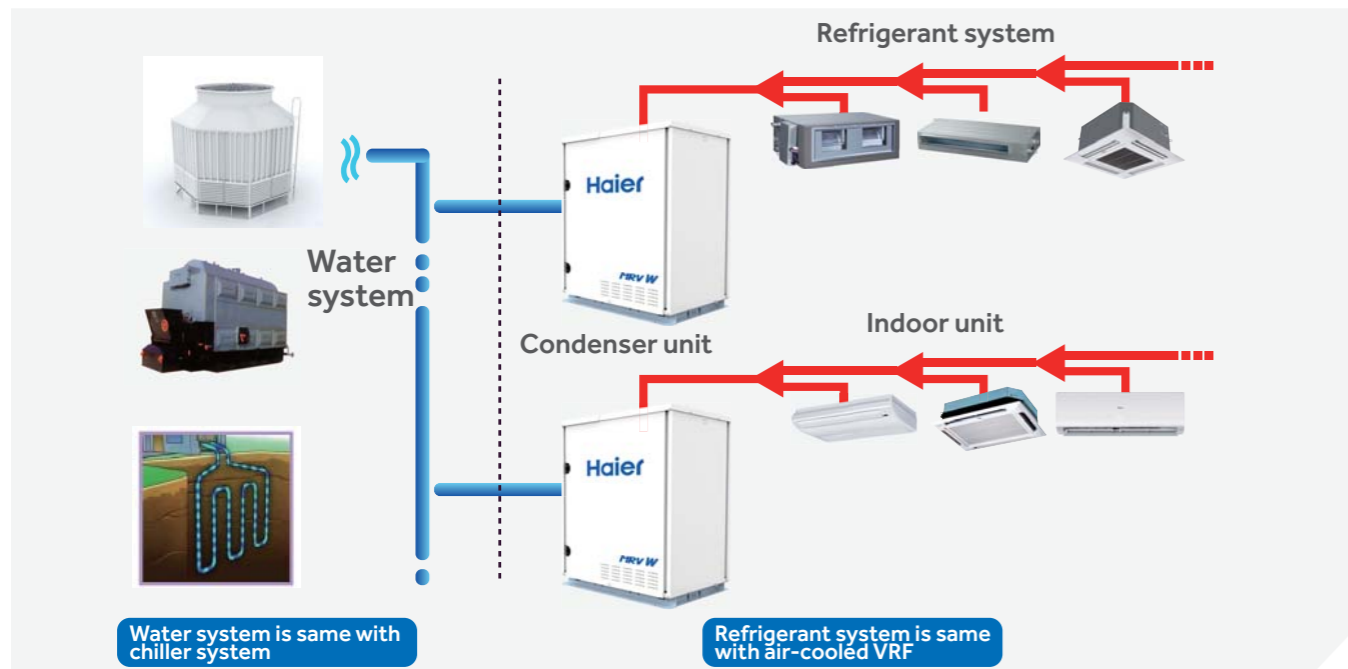

Working Principle

Working principle in cooling mode

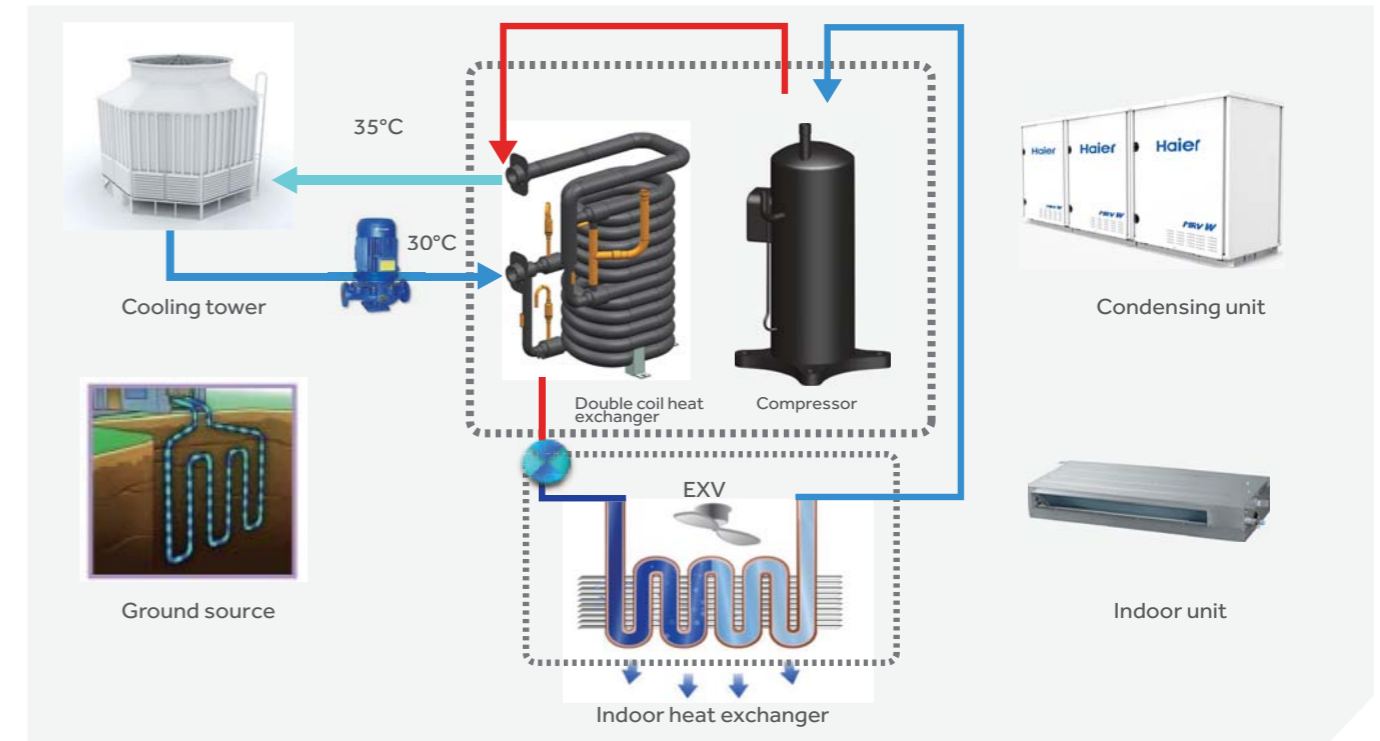

Working principle in heating mode

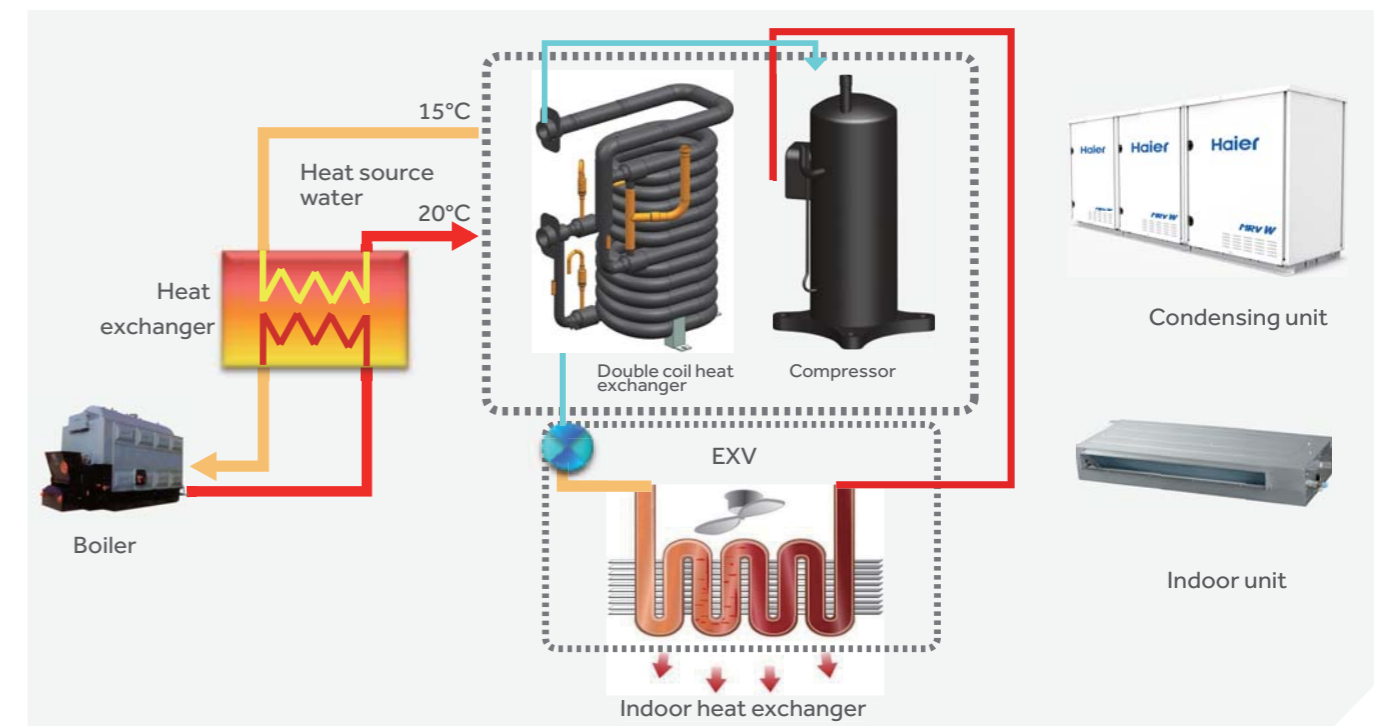

FEATURES & BENEFITS

Outdoor Structure

Core Technologies and Parts (Front Side)

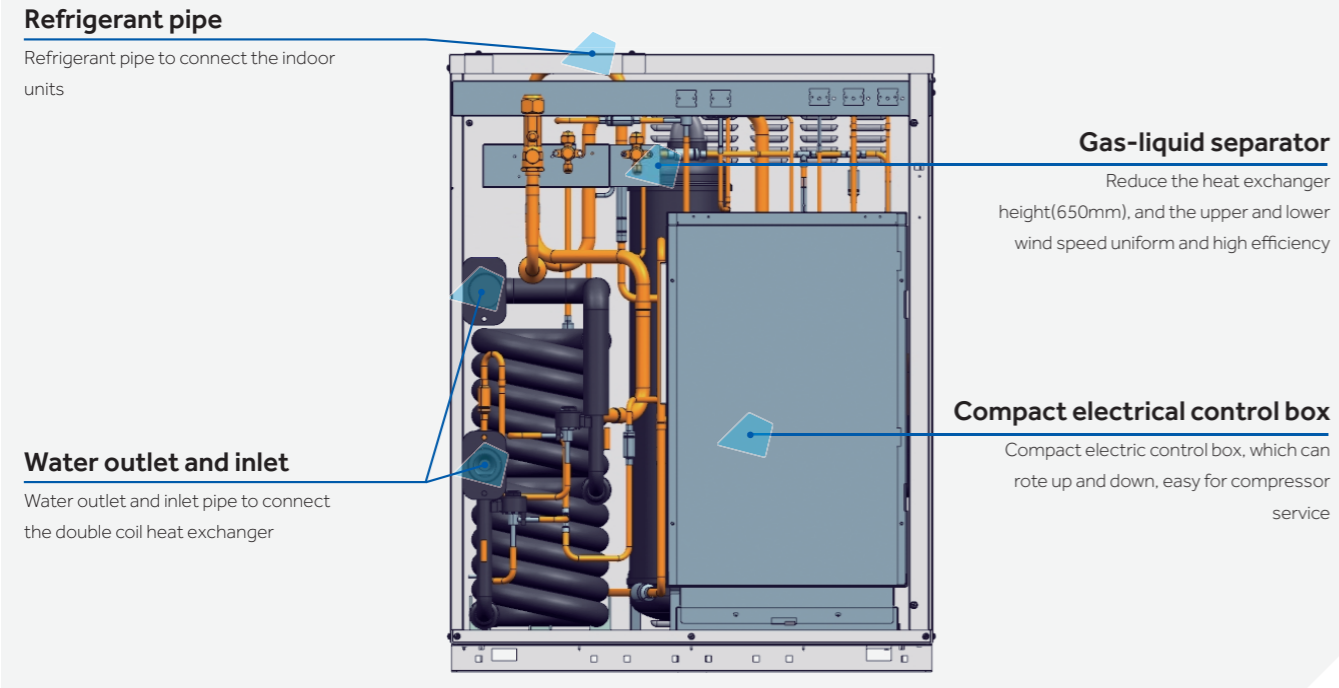

Core Technologies and Parts(Back Side)

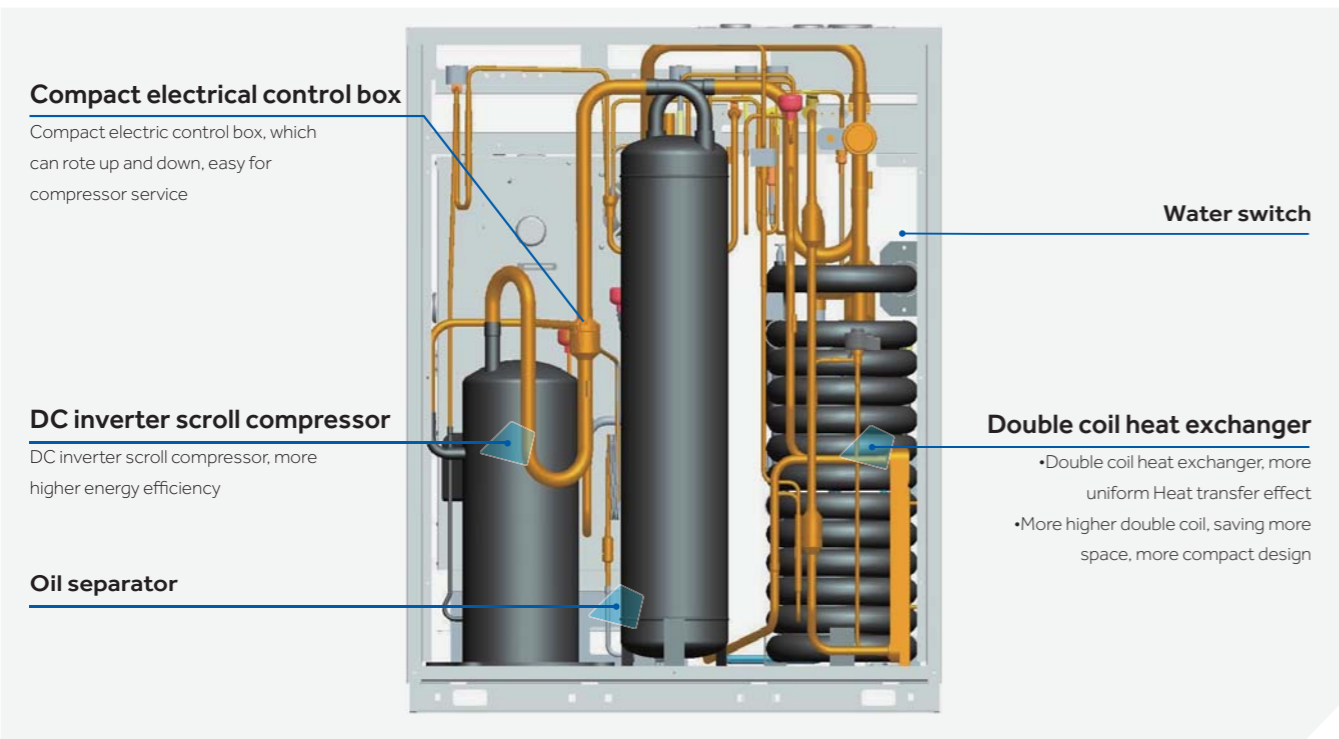

MRV W Application Typical high-rise buildings

3 Types Typical High-rise Buildings

- Compact inner structure and core parts

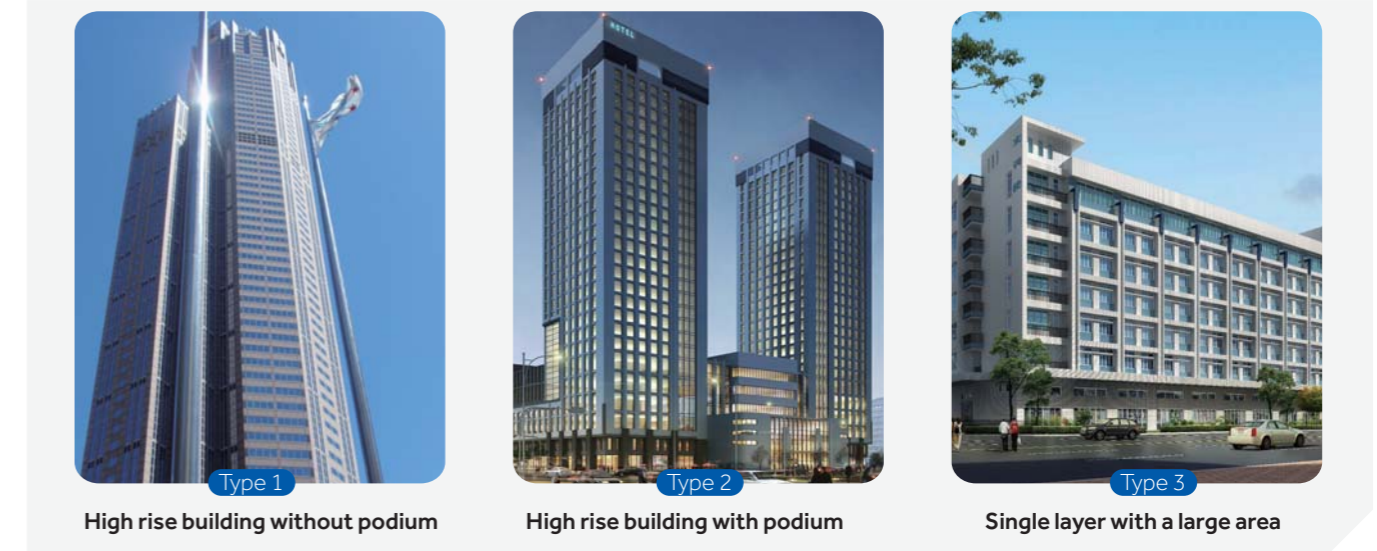

Type 1 High-rise Building

- Conventional chiller system, and new water-cooled MRV solution

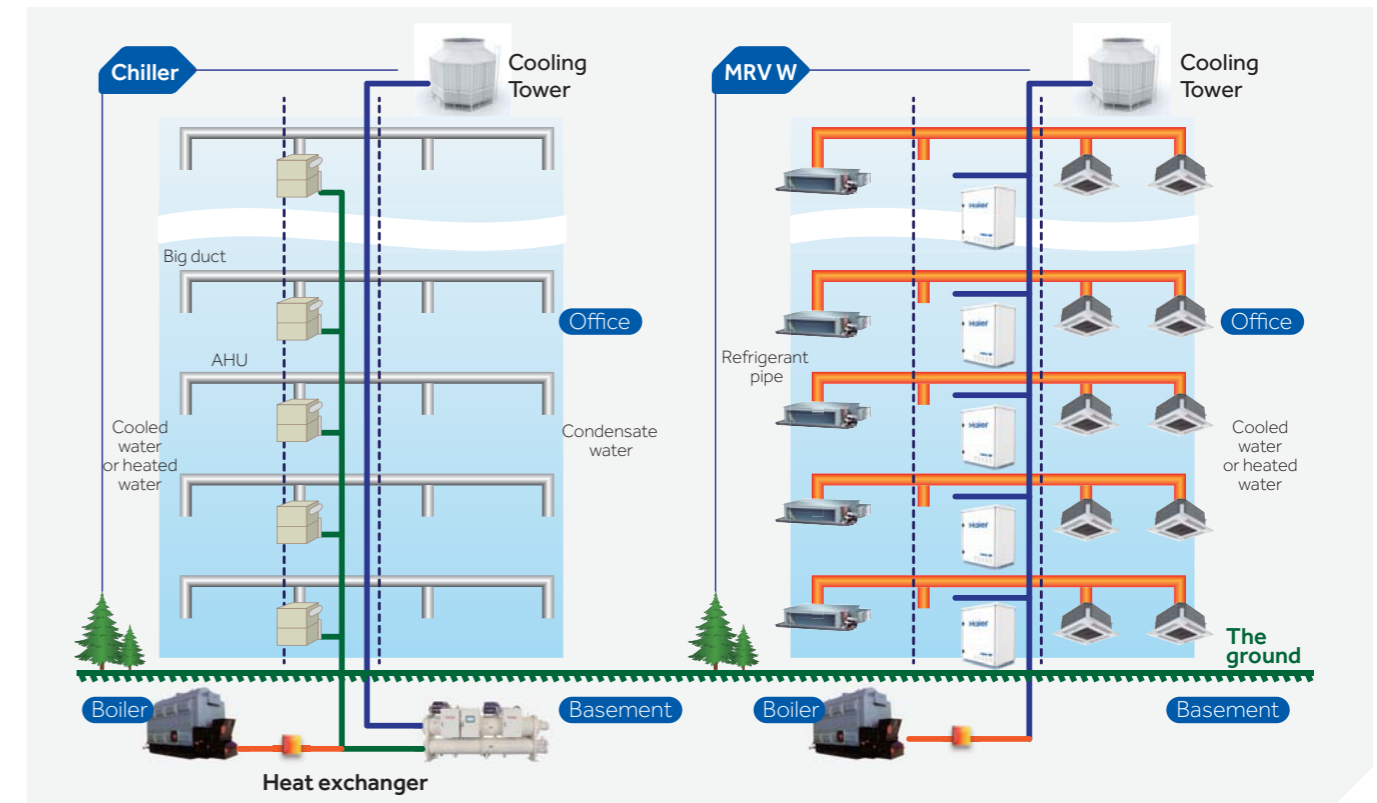

FEATURES & BENEFITS

MRV W Application

Type 2 High-rise Building

•Conventional chiller system, and water-cooled MRV solution

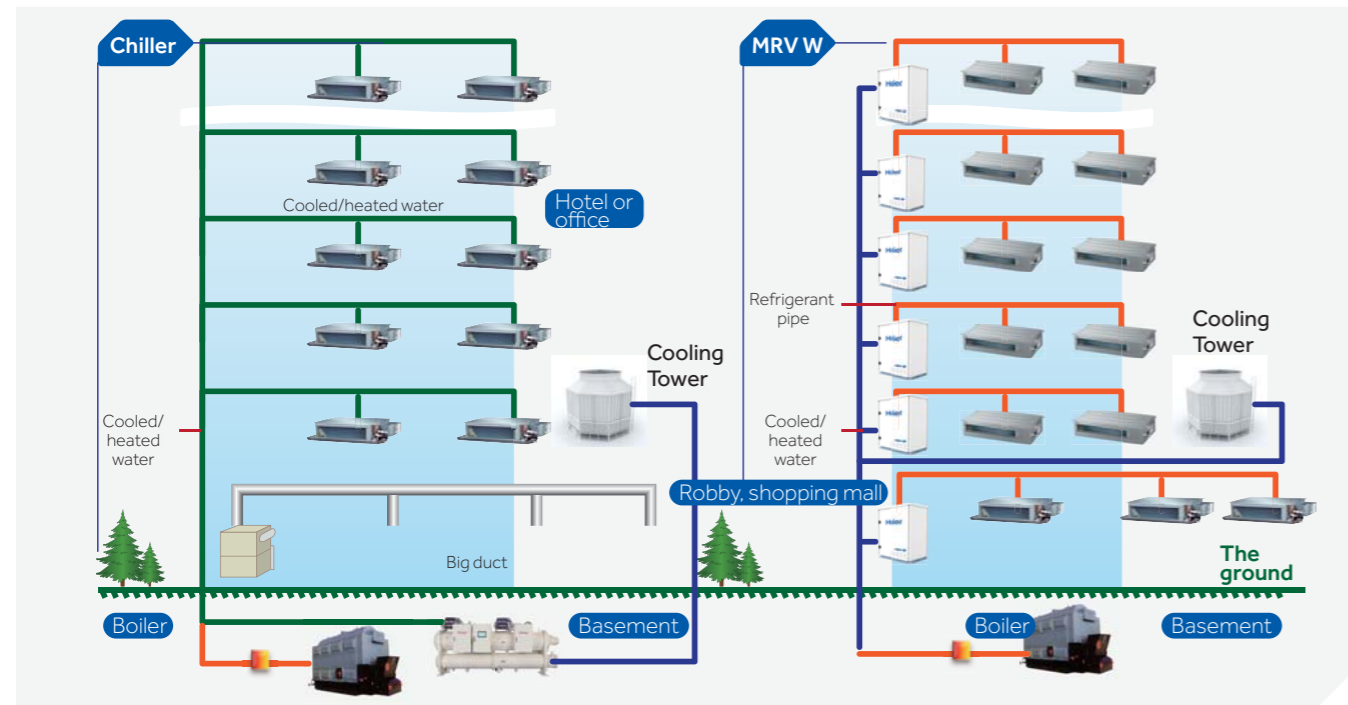

Type 3 High-rise Building

•Conventional chiller system, and water-cooled MRV solution

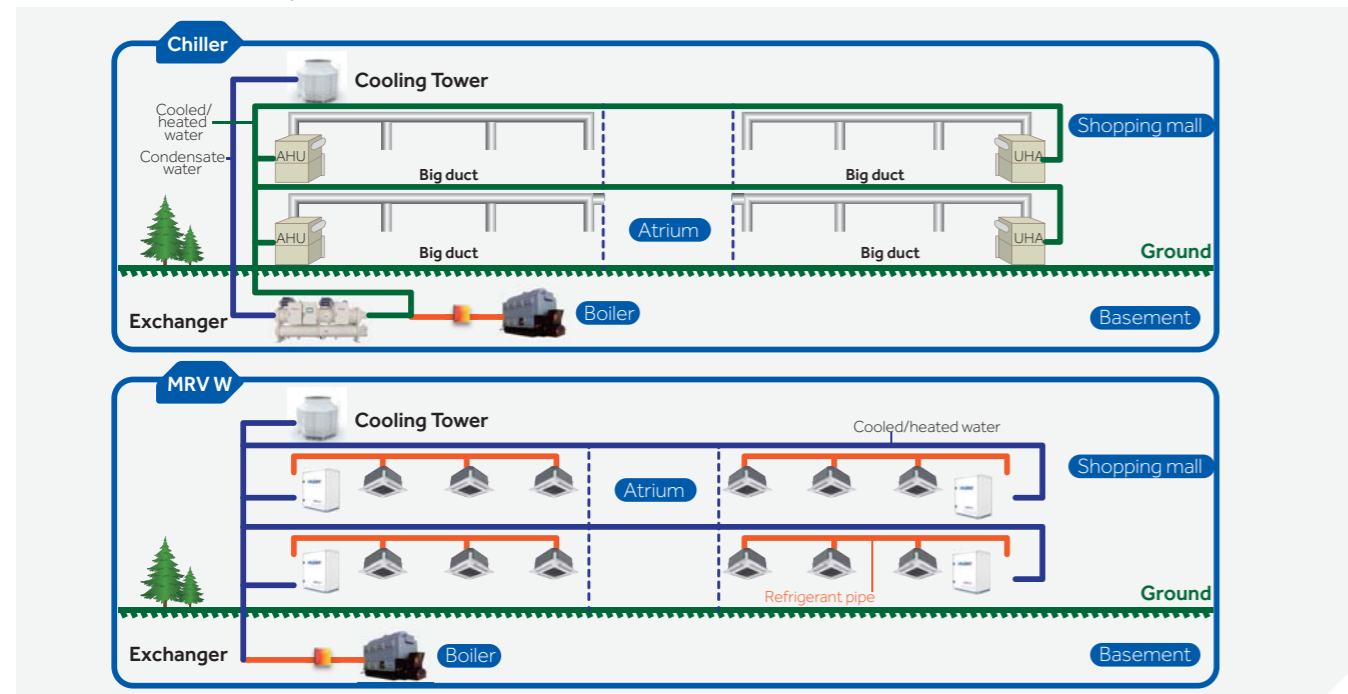

MRV W Application

Buildings That Suitable

- New construction or retrofit building: MRV W provides an energy efficient solution anywhere that could use a water-cooled chiller or replacing water source heat pump design by enabling them to afford the water-cooled chiller benefits. It is especially true for high-rise buildings such as condos, offices, medical centers, schools
- High-rise building that didn't design with VRF system
- Glass curtain wall or special design building
- No enough space to put the outdoor unit even accept the VRF system
- Building which required to renewable energy sources

Benefit

- Lower initial cost for the developer and builder
- Client or developer can add air conditioning to match load requirement
- No rebalancing of water systems if commissioning valves are installed on each floor
- Connect to the full suite of MRV control solution A/C management system
- Separate control to every indoor unit

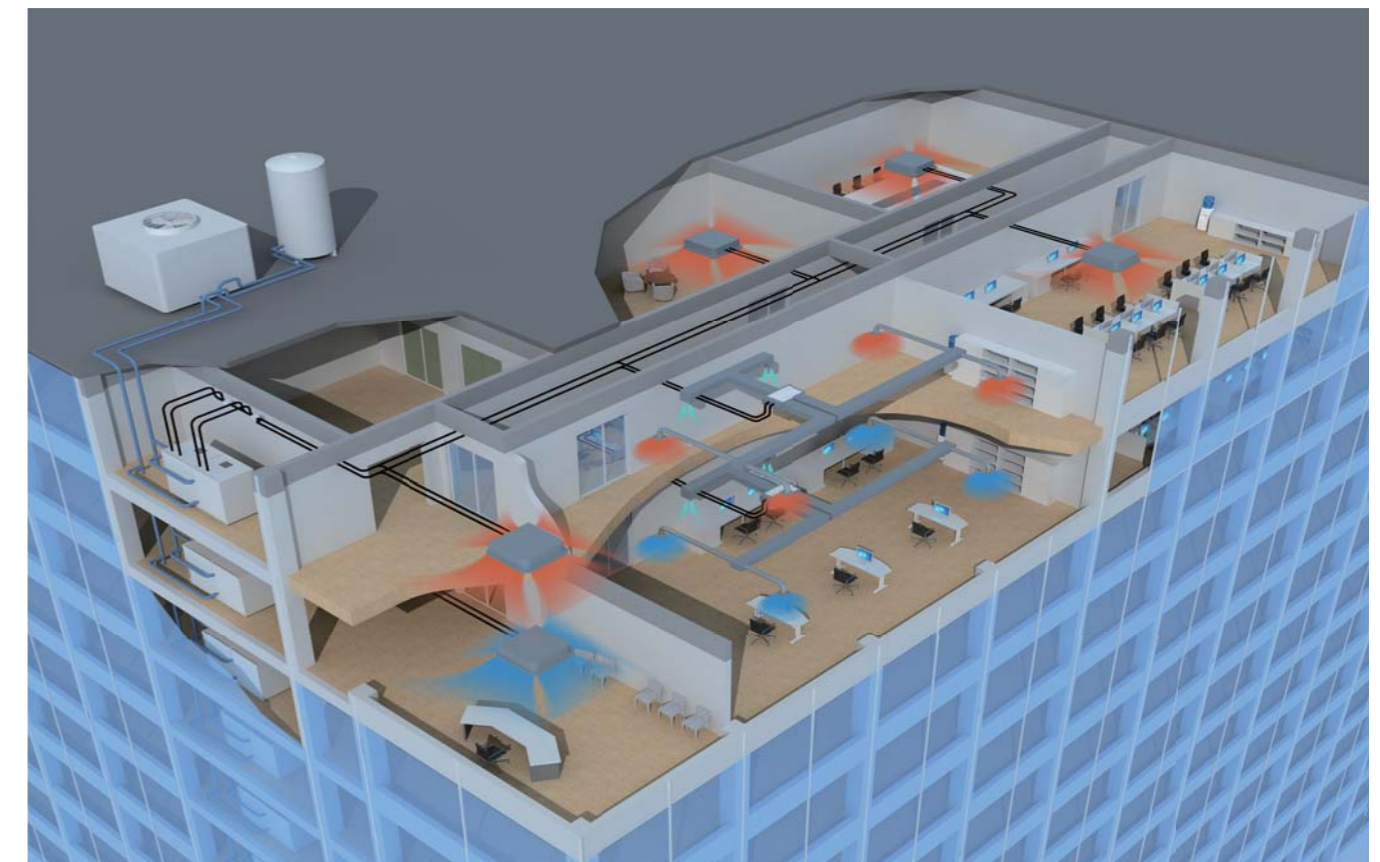

FEATURES & BENEFITS

Overview

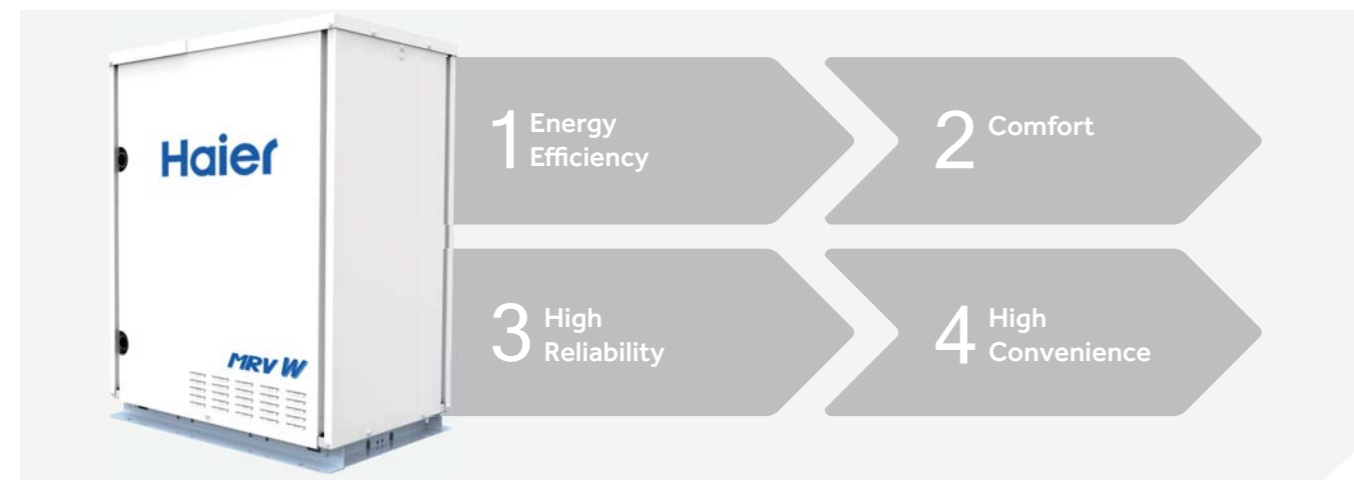

Energy saving

- COP can be up to 6.02, much more higher energy level than air system
- EER can be up to 4.98, more higher energy level than air system

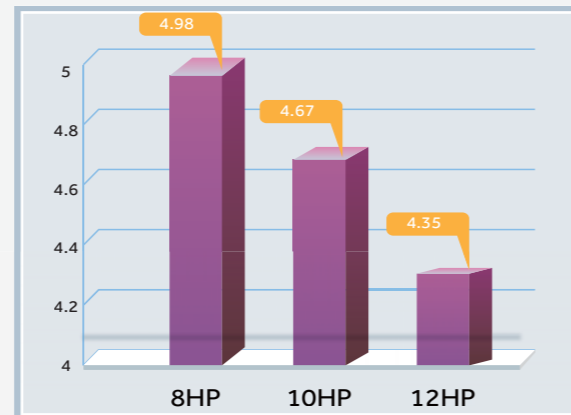
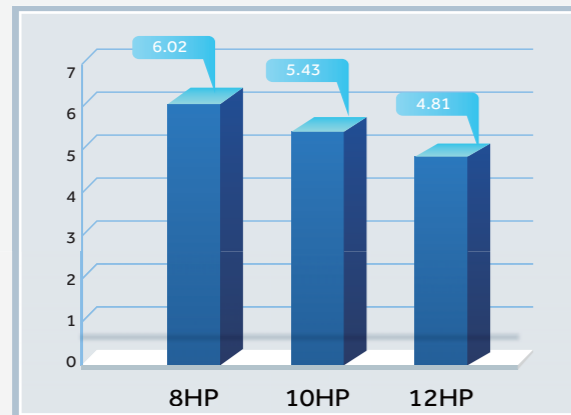

Energy Saving

High efficiency dc inverter compressor

- High efficiency DC inverter compressor from mitsubishi electric



Energy Saving

High efficiency double coil heat exchanger

- Double coil heat-exchanger, more uniform heat transfer effect



Energy Saving

Heat recovery between different refrigerant system

- Heat recovery is achieved within the water loop between different refrigerant system, more higher total COP
- Cooling and heating at the same time in different refrigerant system

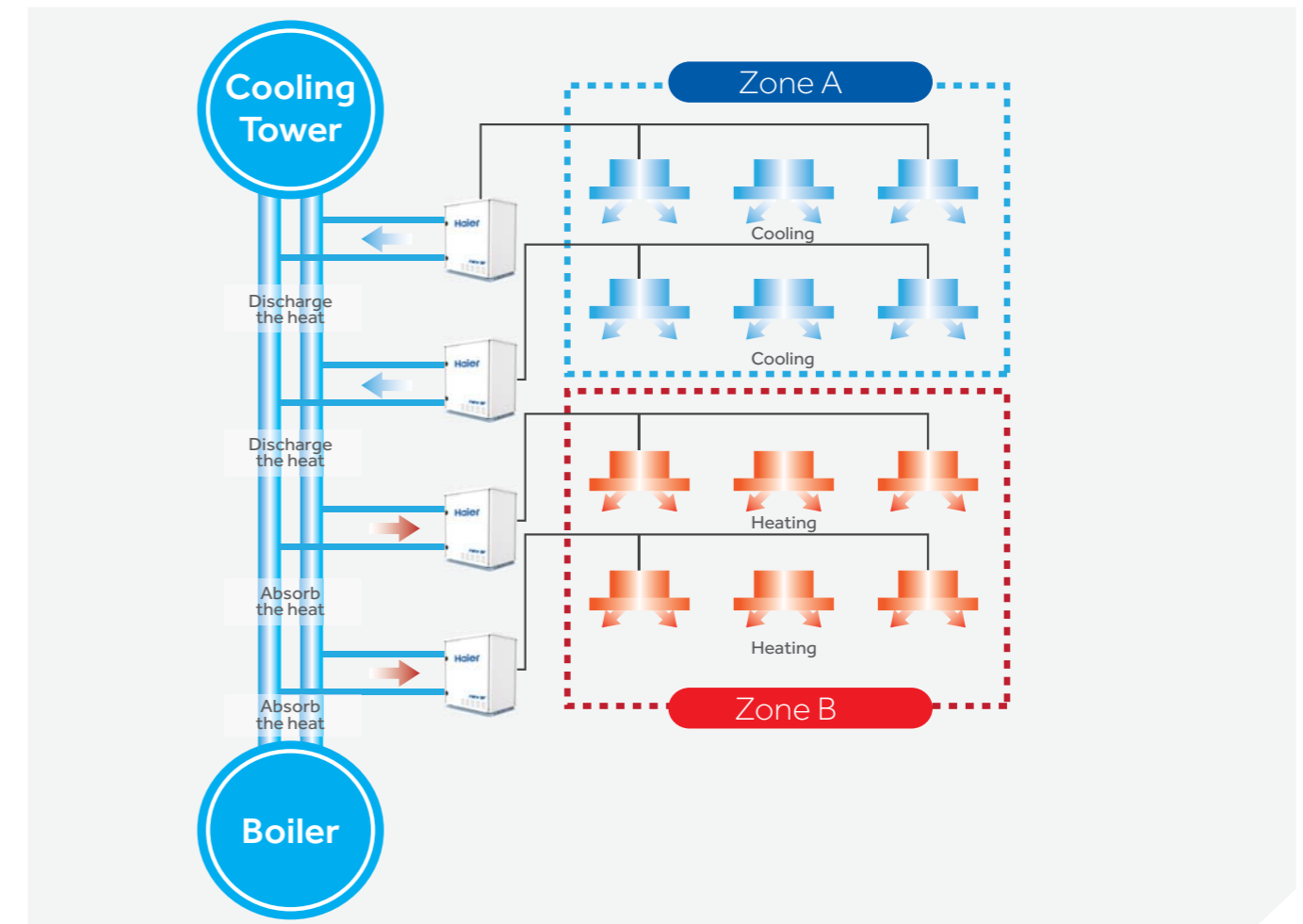

Double EEV Control

- The double EEV control the 2 stages heat exchanger separately, which can adjust the condenser volume

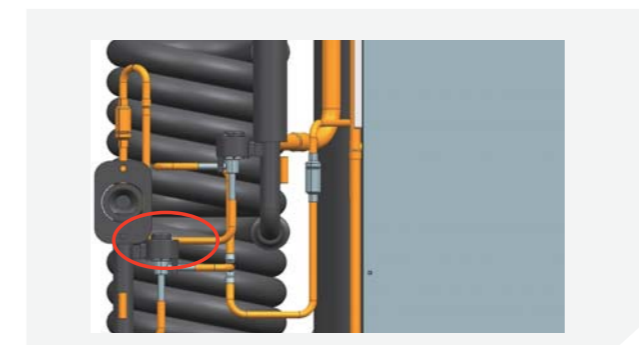

Two Stage Deep Sub Cooling Technology

- 1st stage sub cooling added a sub cooling coil to condenser
- 2nd stage sub cooling added a stand alone sub cooler
- After further cooling, sub-cooling degree can be up to 30°C, with the heat exchanging capacity per unit mass of refrigerant improved by 46% and flow resistance reduced by 55%, and running efficiency improved by 9%

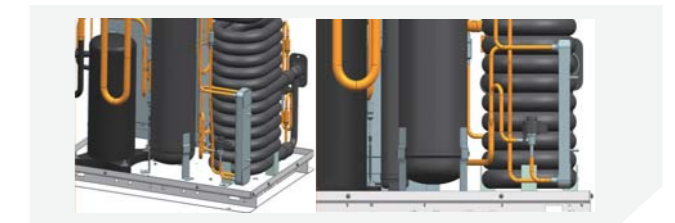

FEATURES & BENEFITS

Comfortable Environment

Low Noise Level

- Comparing with air system, without fan in the outdoor and with full insulation design, the noise level can be reduced to only 50dB(A), much lower than the air system and conventional chiller

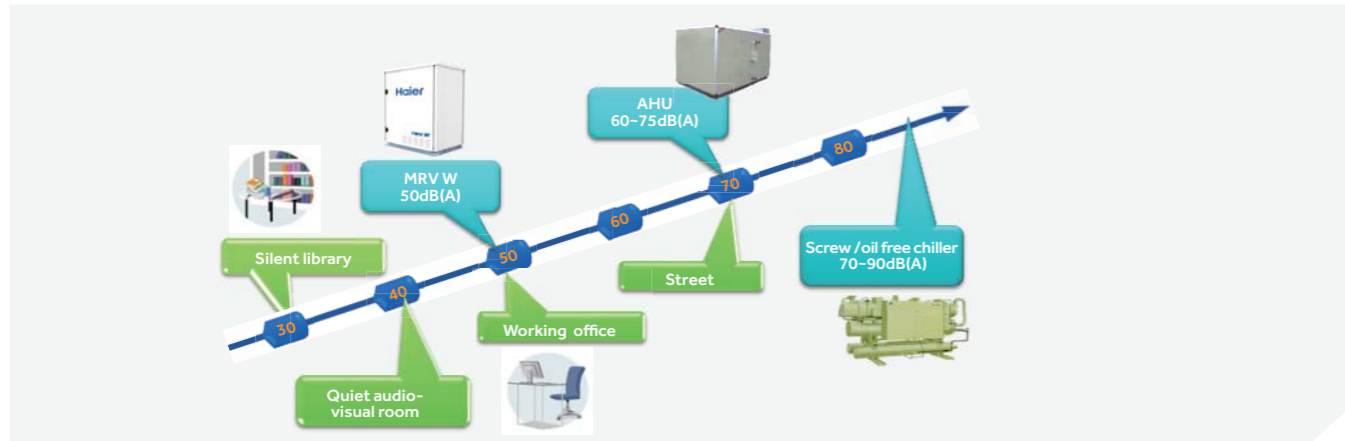

No Influence From Ambient Temperature

- Thanks to the stable water source, the capacity and efficiency will not reduce with extreme ambient conditions compare with air-cooled system
- Especially in heating mode, water cooling means no defrost operation is required, the resultant rapid start up time assures quick and comfortable heating, even in cold environment



High Reliability

Water Pump Controlled Together with the Outdoor

- The reserved water pump linkage control, realize the pump linkage control, reduce the energy consumption and eliminate hidden dangers

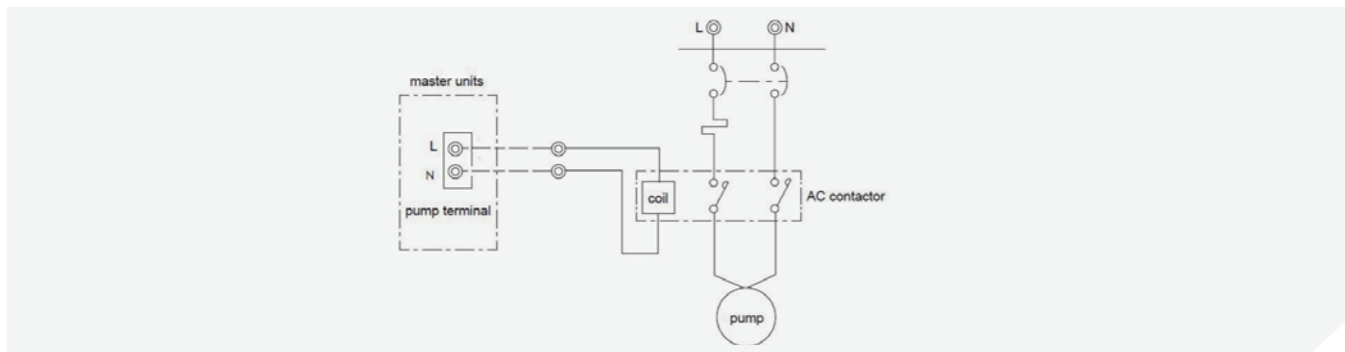

High Convenience (Use/installation/service)

Compact and Lightweight Design

- The industry's most compact and lightweight design, installed in the narrow space.
Comparing with the conventional top discharge air-cooled system, height 45% reduced, footprint 43% reduced



Stacked Installation

- The condensers are smaller and can be stacked, reducing the installation space and increasing the customers usable square footage



High Reliability

Chilled Electric Control Module

- Using refrigerant to reduce the module temperature, to realize stable module temperature, more reliable operation
- Canceling heat dissipation fan of the module, reduce the power consumption and noise level

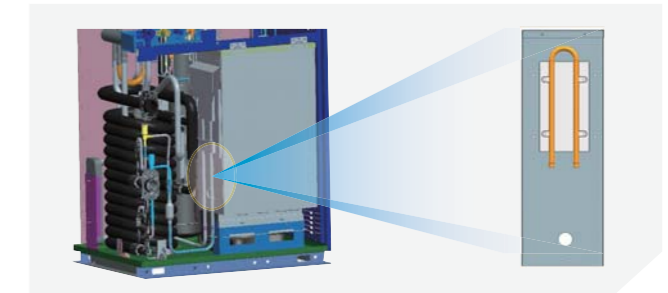

Stable Pressure Setting

- Stable pressure setting design, to make the high pressure keep above the required pressure, ensure the compressor reliability and stable capacity output

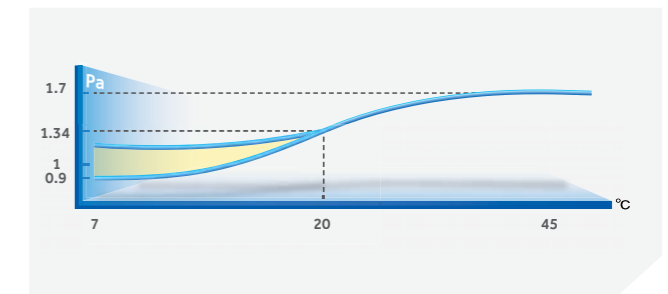

Wide Operation Range

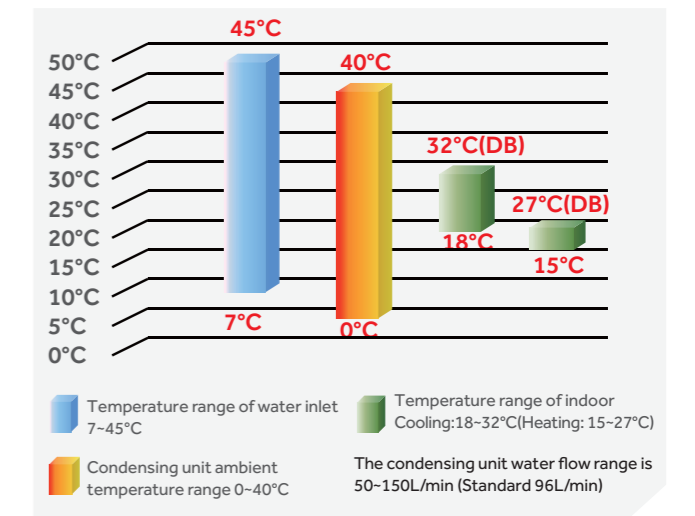

FEATURES & BENEFITS

Energy Efficiency

Long Pipe Length and High Height Drop

The condensers are smaller and can be staked, reducing the installation space and increasing the customers' usable square footage

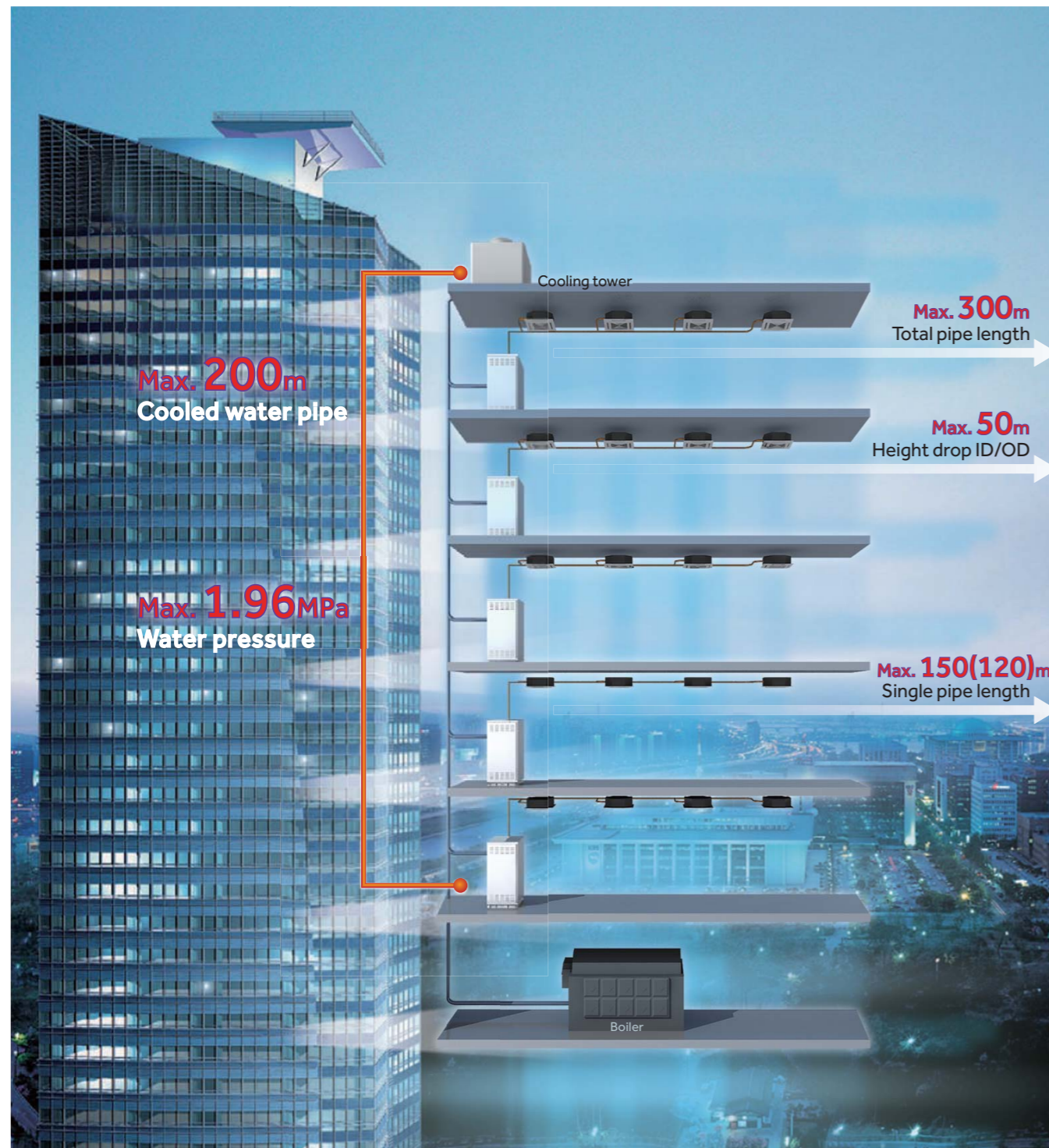

Energy Efficiency

Flexible Water Pipe Design

- Max water pressure can be up to 1.96MPa
- Condensate pipe length can be up to 200m

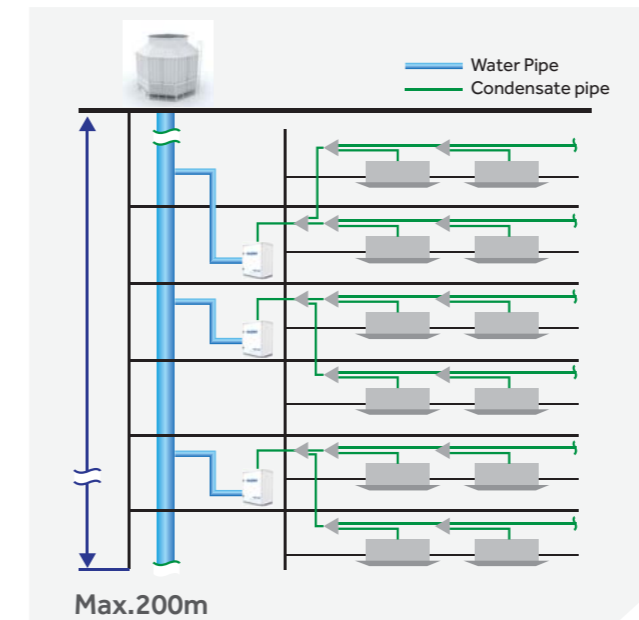

Energy Efficiency

Flexible Installation Location

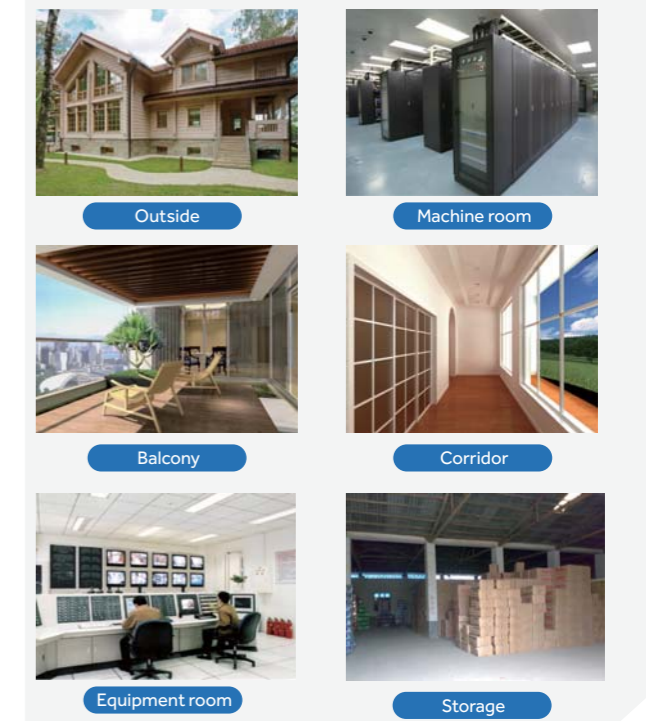

High Convenience (Use/installation/service)

Various Mode and Priority Selection

- The condensers are smaller and can be staked, reducing the installation space and increasing the customers' usable square footage



Easy Maintenance

Compact outdoor structure design

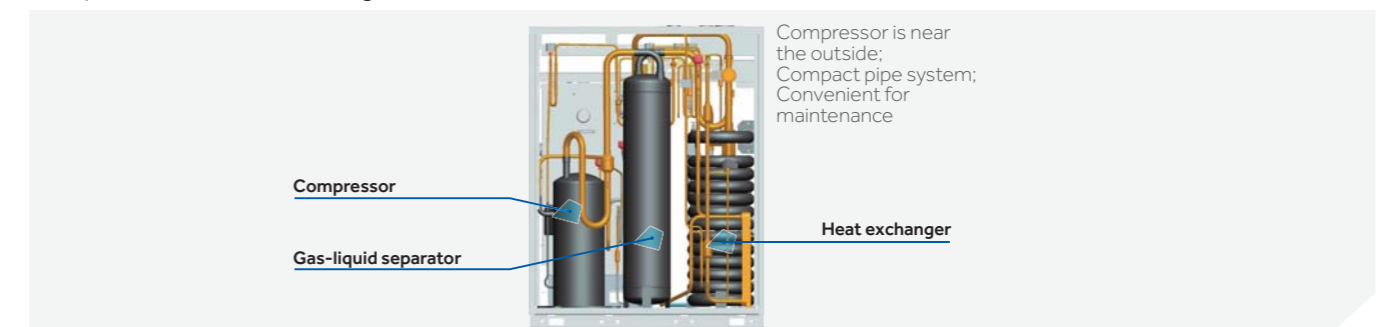

MRV W OUTDOOR 3Ph/380-400V/50(60)Hz



8/10/12HP



Water Source MRV Outdoor Unit, Combine Water System and Refrigerant System in one System
 3 Basic Single Module:8/10/12HP, Max 3 Modules Combination up to 36HP
 Most Compact Size Outdoor Design in the Industry
 Total 300m Long Pipe Length, Easy for Installation
 Double Coil Outdoor Heat Exchanger
 Compatible with all the MRV Indoor Units



Model		AV08IMWEWA	AV10IMWEWA	AV12IMWEWA	AV16IMWEWA	AV18IMWEWA	AV20IMWEWA	AV22IMWEWA	AV24IMWEWA	AV26IMWEWA	AV28IMWEWA	AV30IMWEWA	AV32IMWEWA	AV34IMWEWA	AV36IMWEWA		
Combination model		/	/	/	AV08IMWEWA	AV08IMWEWA	AV10IMWEWA	AV10IMWEWA	AV12IMWEWA	AV12IMWEWA	AV08IMWEWA	AV10IMWEWA	AV10IMWEWA	AV10IMWEWA	AV12IMWEWA		
		/	/	/	AV08IMWEWA	AV10IMWEWA	AV10IMWEWA	AV12IMWEWA	AV12IMWEWA	AV08IMWEWA	AV10IMWEWA	AV10IMWEWA	AV10IMWEWA	AV12IMWEWA	AV12IMWEWA		
		/	/	/	/	/	/	/	/	AV10IMWEWA	AV10IMWEWA	AV10IMWEWA	AV12IMWEWA	AV12IMWEWA	AV12IMWEWA		
Capacity	Capacity range	HP	8	10	12	16	18	20	22	24	26	28	30	32	34	36	
	Cooling capacity	kW	22.4	28	33.5	44.8	50.4	56	61.5	67.0	72.8	78.4	84.0	89.5	95.0	100.5	
	Heating capacity	kW	25	31.5	37.5	50.0	56.5	63	69.0	75.0	81.5	88.0	94.5	100.5	106.5	112.5	
Electrical parameters	Power supply	PhV/Hz	3/380-400/50/60	3/380-400/50/60	3/380-400/50/60	3/380-400/50/60	3/380-400/50/60	3/380-400/50/60	3/380-400/50/60	3/380-400/50/60	3/380-400/50/60	3/380-400/50/60	3/380-400/50/60	3/380-400/50/60	3/380-400/50/60	3/380-400/50/60	
	Cooling	Rated power input	kW	4.50	6.00	7.70	9.00	10.50	12.00	13.70	15.40	15.00	16.50	18.00	19.70	21.40	23.10
		Max. power input	kW	13.00	15.00	17.00	26.00	28.00	30.00	32.00	34.00	41.00	43.00	45.00	47.00	49.00	51.00
		Rated current	A	7.20	9.60	12.32	14.39	16.79	19.19	21.91	24.63	23.99	26.39	28.79	31.51	34.23	36.95
		Max. current	A	20.79	23.99	27.19	41.58	44.78	47.98	51.18	54.38	65.57	68.77	71.97	75.17	78.37	81.57
	Heating	Rated power input	kW	4.15	5.80	7.80	8.30	9.95	11.60	13.60	15.60	14.10	15.75	17.40	19.40	21.40	23.40
		Max. power input	kW	13.00	15.00	17.00	26.00	28.00	30.00	32.00	34.00	41.00	43.00	45.00	47.00	49.00	51.00
		Rated current	A	6.64	9.28	12.47	13.27	15.91	18.55	21.75	24.95	22.55	25.19	27.83	31.03	34.23	37.42
		Max. current	A	20.79	23.99	27.19	41.58	44.78	47.98	51.18	54.38	65.57	68.77	71.97	75.17	78.37	81.57
	EER/COP		4.98/6.02	4.67/5.43	4.35/4.81	4.98/6.02	4.80/5.68	4.67/5.43	4.49/5.07	4.35/4.81	4.85/5.78	4.75/5.59	4.67/5.43	4.54/5.18	4.44/4.98	4.35/4.81	
Performance	Water flow (H)	m ³ /h	4.8	6	7.2	9.6	10.8	12	13.2	14.4	15.6	16.8	18.0	19.2	20.4	21.6	
	Sound pressure level (H)	dB(A)	50	51	53	53	54	54	55	56	55	55	56	57	57	58	
	Sound power level (H)	dB(A)	61	62	64	64	65	65	66	67	66	66	67	68	68	69	
	External dimensions(W/D/H)	mm	775/545/995	775/545/995	775/545/995	(775/545/995)*2	(775/545/995)*2	(775/545/995)*2	(775/545/995)*2	(775/545/995)*2	(775/545/995)*2	(775/545/995)*3	(775/545/995)*3	(775/545/995)*3	(775/545/995)*3	(775/545/995)*3	
Shipping dimensions(W/D/H)	mm	840/625/1150	840/625/1150	840/625/1150	(840/625/1150)*2	(840/625/1150)*2	(840/625/1150)*2	(840/625/1150)*2	(840/625/1150)*2	(840/625/1150)*2	(840/625/1150)*3	(840/625/1150)*3	(840/625/1150)*3	(840/625/1150)*3	(840/625/1150)*3		
Net/Shipping weight	kg	172/183	172/183	172/183	344/366	344/366	344/366	344/366	344/366	344/366	516/549	516/549	516/549	516/549	516/549		
Installation	Compressor type		DC INV. SCROLL	DC INV. SCROLL	DC INV. SCROLL	DC INV. SCROLL	DC INV. SCROLL	DC INV. SCROLL	DC INV. SCROLL	DC INV. SCROLL	DC INV. SCROLL	DC INV. SCROLL	DC INV. SCROLL	DC INV. SCROLL	DC INV. SCROLL		
	Compressor quantity		1 INV	1 INV	1 INV	2 INV	2 INV	2 INV	2 INV	2 INV	3 INV	3 INV	3 INV	3 INV	3 INV		
	Refrigerant type		R410A	R410A	R410A	R410A	R410A	R410A	R410A	R410A	R410A	R410A	R410A	R410A	R410A	R410A	
	Refrigerant charge	kg	2	2	2	4	4	4	4	4	6	6	6	6	6	6	
	Refrigerant liquid pipe	mm	9.52	9.52	12.7	12.7	15.88	15.88	15.88	15.88	19.05	19.05	19.05	19.05	19.05	19.05	
	Refrigerant gas pipe	mm	19.05	28.22	25.4	28.58	28.58	28.58	28.58	28.58	31.8	31.8	31.8	31.8	31.8	31.8	
	Oil equalization pipe	mm	9.52	9.52	9.52	9.52	9.52	9.52	9.52	9.52	9.52	9.52	9.52	9.52	9.52	9.52	
	Total pipe length	m	300	300	300	300	300	300	300	300	300	300	300	300	300	300	
	Max. pipe length(Equivalent/Actual)	m	150/120	150/120	150/120	150/120	150/120	150/120	150/120	150/120	150/120	150/120	150/120	150/120	150/120	150/120	
	Max drop between I.U.&O.U	m	50/40	50/40	50/40	50/40	50/40	50/40	50/40	50/40	50/40	50/40	50/40	50/40	50/40	50/40	
Heat Exchanger	Type		Double coil	Double coil	Double coil	Double coil	Double coil	Double coil	Double coil	Double coil	Double coil	Double coil	Double coil	Double coil	Double coil		
	Material		Copper	Copper	Copper	Copper	Copper	Copper	Copper	Copper	Copper	Copper	Copper	Copper	Copper		
	Inlet water connection pipe	mm	DN32	DN32	DN32	DN32	DN32	DN32	DN32	DN32	DN32	DN32	DN32	DN32	DN32	DN32	
Water side	Outlet water connection pipe	mm	DN32	DN32	DN32	DN32	DN32	DN32	DN32	DN32	DN32	DN32	DN32	DN32	DN32		
	pressure drop(inlet and outlet)	Kpa	35	50	70	35+35	35+50	50+50	50+70	70+70	35+35+50	35+50+50	50+50+70	50+70+70	70+70+70		
	Connection type		inner grooved	inner grooved	inner grooved	inner grooved	inner grooved	inner grooved	inner grooved	inner grooved	inner grooved	inner grooved	inner grooved	inner grooved	inner grooved		
	Max. system water pressure	Mpa	1.6	1.6	1.6	1.6	1.6	1.6	1.6	1.6	1.6	1.6	1.6	1.6	1.6		
Connection ratio	Inlet water temperature range (Cooling & Heating)	°C	7-45	7-45	7-45	7-45	7-45	7-45	7-45	7-45	7-45	7-45	7-45	7-45	7-45		
	Connectable indoor unit ratio	%	50-130	50-130	50-130	50-130	50-130	50-130	50-130	50-130	50-130	50-130	50-130	50-130	50-130		
Maximum number of indoor units	unt	13	16	19	23	29	33	36	39	43	46	50	53	56	59		

* 1 outdoor above 50m outdoor below 40m.
 All the specifications are tested under nominal condition(In cooling, Indoor temp is 27°C DB/19°C WB; Outdoor temp is 35°C DB/24°C WB; In heating, Indoor temp is 20°C DB, Outdoor temp is 7°C DB/6°C WB).
 The specification may change according to the further product development.

MRV W OUTDOOR 3Ph/208-230V/60Hz



8/10/12HP



Model		AV08CMWEWA	AV10CMWEWA	AV12CMWEWA	AV16CMWEWA	AV18CMWEWA	AV20CMWEWA	AV22CMWEWA	AV24CMWEWA	AV26CMWEWA	AV28CMWEWA	AV30CMWEWA	AV32CMWEWA	AV34CMWEWA	AV36CMWEWA		
Combination model		/	/	/	AV08CMWEWA	AV08CMWEWA	AV10CMWEWA	AV10CMWEWA	AV12CMWEWA	AV12CMWEWA	AV08CMWEWA	AV08CMWEWA	AV10CMWEWA	AV10CMWEWA	AV12CMWEWA		
		/	/	/	AV08CMWEWA	AV10CMWEWA	AV10CMWEWA	AV12CMWEWA	AV12CMWEWA	AV08CMWEWA	AV10CMWEWA	AV10CMWEWA	AV10CMWEWA	AV12CMWEWA	AV12CMWEWA		
		/	/	/	/	/	/	/	/	AV10CMWEWA	AV10CMWEWA	AV10CMWEWA	AV12CMWEWA	AV12CMWEWA	AV12CMWEWA		
Capacity	Capacity range	HP	8	10	12	16	18	20	22	24	26	28	30	32	34	36	
	Cooling capacity	kW	22.4	28	33.5	44.8	50.4	56	61.5	67.0	72.8	78.4	84.0	89.5	95.0	100.5	
	Heating capacity	kW	25	31.5	37.5	50.0	56.5	63	69.0	75.0	81.5	88.0	94.5	100.5	106.5	112.5	
Electrical parameters	Power supply	Ph/V/Hz	3/208-230/60	3/208-230/60	3/208-230/60	3/208-230/60	3/208-230/60	3/208-230/60	3/208-230/60	3/208-230/60	3/208-230/60	3/208-230/60	3/208-230/60	3/208-230/60	3/208-230/60	3/208-230/60	
	Cooling	Rated power input	kW	4.50	6.00	7.70	9.00	10.50	12.00	13.70	15.40	15.00	16.50	18.00	19.70	21.40	23.10
		Max. power input	kW	13.00	15.00	17.00	26.00	28.00	30.00	32.00	34.00	41.00	43.00	45.00	47.00	49.00	51.00
		Rated current	A	12.43	16.58	21.27	24.86	29.01	33.15	37.85	42.54	41.44	45.58	49.73	54.42	59.12	63.81
		Max. current	A	35.91	41.44	46.96	71.83	77.35	82.88	88.40	93.93	113.26	118.79	124.31	129.84	135.36	140.89
	Heating	Rated power input	kW	4.15	5.80	7.80	8.30	9.95	11.60	13.60	15.60	14.10	15.75	17.40	19.40	21.40	23.40
		Max. power input	kW	13.00	15.00	17.00	26.00	28.00	30.00	32.00	34.00	41.00	43.00	45.00	47.00	49.00	51.00
		Rated current	A	11.46	16.02	21.55	22.93	27.49	32.05	37.57	43.10	38.95	43.51	48.07	53.59	59.12	64.64
		Max. current	A	35.91	41.44	46.96	71.83	77.35	82.88	88.40	93.93	113.26	118.79	124.31	129.84	135.36	140.89
	EER/COP		4.98/6.02	4.67/5.43	4.35/4.81	4.98/6.02	4.8/5.68	4.67/5.43	4.49/5.07	4.35/4.81	4.85/5.78	4.75/5.59	4.67/5.43	4.54/5.18	4.44/4.98	4.35/4.81	
Performance	Water flow (H)	m ³ /h	4.8	6	7.2	9.6	10.8	12	13.2	14.4	15.6	16.8	18.0	19.2	20.4	21.6	
	Sound pressure level (H)	dB(A)	50	51	53	53	54	54	55	56	55	55	56	57	57	58	
	Sound power level (H)	dB(A)	61	62	64	64	65	65	66	67	66	66	67	68	68	69	
	External dimensions(W/D/H)	mm	775/545/995	775/545/995	775/545/995	(775/545/995)*2	(775/545/995)*2	(775/545/995)*2	(775/545/995)*2	(775/545/995)*2	(775/545/995)*2	(775/545/995)*3	(775/545/995)*3	(775/545/995)*3	(775/545/995)*3	(775/545/995)*3	
Shipping dimensions(W/D/H)	mm	875/655/1182	875/655/1182	875/655/1182	(875/655/1182)*2	(875/655/1182)*2	(875/655/1182)*2	(875/655/1182)*2	(875/655/1182)*2	(875/655/1182)*2	(875/655/1182)*3	(875/655/1182)*3	(875/655/1182)*3	(875/655/1182)*3	(875/655/1182)*3		
Net/Shipping weight	kg	172/183	172/183	172/183	344/366	344/366	344/366	344/366	344/366	344/366	516/549	516/549	516/549	516/549	516/549		
Installation	Compressor type		DC INV. SCROLL	DC INV. SCROLL	DC INV. SCROLL	DC INV. SCROLL	DC INV. SCROLL	DC INV. SCROLL	DC INV. SCROLL	DC INV. SCROLL	DC INV. SCROLL	DC INV. SCROLL	DC INV. SCROLL	DC INV. SCROLL	DC INV. SCROLL		
	Compressor quantity		1 INV	1 INV	1 INV	2 INV	2 INV	2 INV	2 INV	2 INV	3 INV	3 INV	3 INV	3 INV	3 INV		
	Refrigerant type		R410A	R410A	R410A	R410A	R410A	R410A	R410A	R410A	R410A	R410A	R410A	R410A	R410A		
	Refrigerant charge	kg	2	2	2	4	4	4	4	4	6	6	6	6	6		
	Refrigerant liquid pipe	mm	9.52	9.52	12.7	12.7	15.9	15.9	15.9	15.9	19.1	19.1	19.1	19.1	19.1		
	Refrigerant gas pipe	mm	19.05	22.2	25.4	28.6	28.6	28.6	28.6	28.6	31.8	31.8	31.8	31.8	31.8		
	Oil equalization pipe	mm	9.52	9.52	9.52	9.52	9.52	9.52	9.52	9.52	9.52	9.52	9.52	9.52	9.52		
	Total pipe length	m	300	300	300	300	300	300	300	300	300	300	300	300	300		
	Max. pipe length(Equivalent/Actual)	m	150/120	150/120	150/120	150/120	150/120	150/120	150/120	150/120	150/120	150/120	150/120	150/120	150/120		
	Max drop between I.U.&O.U	m	50/40	50/40	50/40	50/40	50/40	50/40	50/40	50/40	50/40	50/40	50/40	50/40	50/40		
Heat Exchanger	Type		Double coil	Double coil	Double coil	Double coil	Double coil	Double coil	Double coil	Double coil	Double coil	Double coil	Double coil	Double coil	Double coil		
	Material		Copper&Steel	Copper&Steel	Copper&Steel	Copper&Steel	Copper&Steel	Copper&Steel	Copper&Steel	Copper&Steel	Copper&Steel	Copper&Steel	Copper&Steel	Copper&Steel	Copper&Steel		
Water side	Inlet water connection pipe	mm	DN32	DN32	DN32	DN32	DN32	DN32	DN32	DN32	DN32	DN32	DN32	DN32	DN32		
	Outlet water connection pipe	mm	DN32	DN32	DN32	DN32	DN32	DN32	DN32	DN32	DN32	DN32	DN32	DN32	DN32		
	pressure drop(inlet and outlet)	Kpa	35	50	70	35+35	35+50	50+50	50+70	70+70	35+35+50	35+50+50	50+50+70	50+70+70	70+70+70		
	Connection type		inner grooved	inner grooved	inner grooved	inner grooved	inner grooved	inner grooved	inner grooved	inner grooved	inner grooved	inner grooved	inner grooved	inner grooved	inner grooved		
	Max. system water pressure	Mpa	1.6	1.6	1.6	1.6	1.6	1.6	1.6	1.6	1.6	1.6	1.6	1.6	1.6		
Connection ratio	Connectable indoor unit ratio	%	50-130	50-130	50-130	50-130	50-130	50-130	50-130	50-130	50-130	50-130	50-130	50-130	50-130		
	Maximum number of indoor units	unt	13	16	19	23	29	33	36	39	43	46	50	53	56		

* 1 outdoor above 50m outdoor below 40m.
 All the specifications are tested under nominal condition(In cooling, Indoor temp is 27°C DB/19°C WB; Outdoor temp is 35°C DB/24°C WB; In heating, Indoor temp is 20°C DB, Outdoor temp is 7°C DB/6°C WB).
 The specification may change according to the further product development.



EASY MRV KIT

- | 103 Features & Benefits
- | 107 Easy MRV Outdoor

FEATURES & BENEFITS

Intergraded System Solution

System Connection Kit to link the systems together.

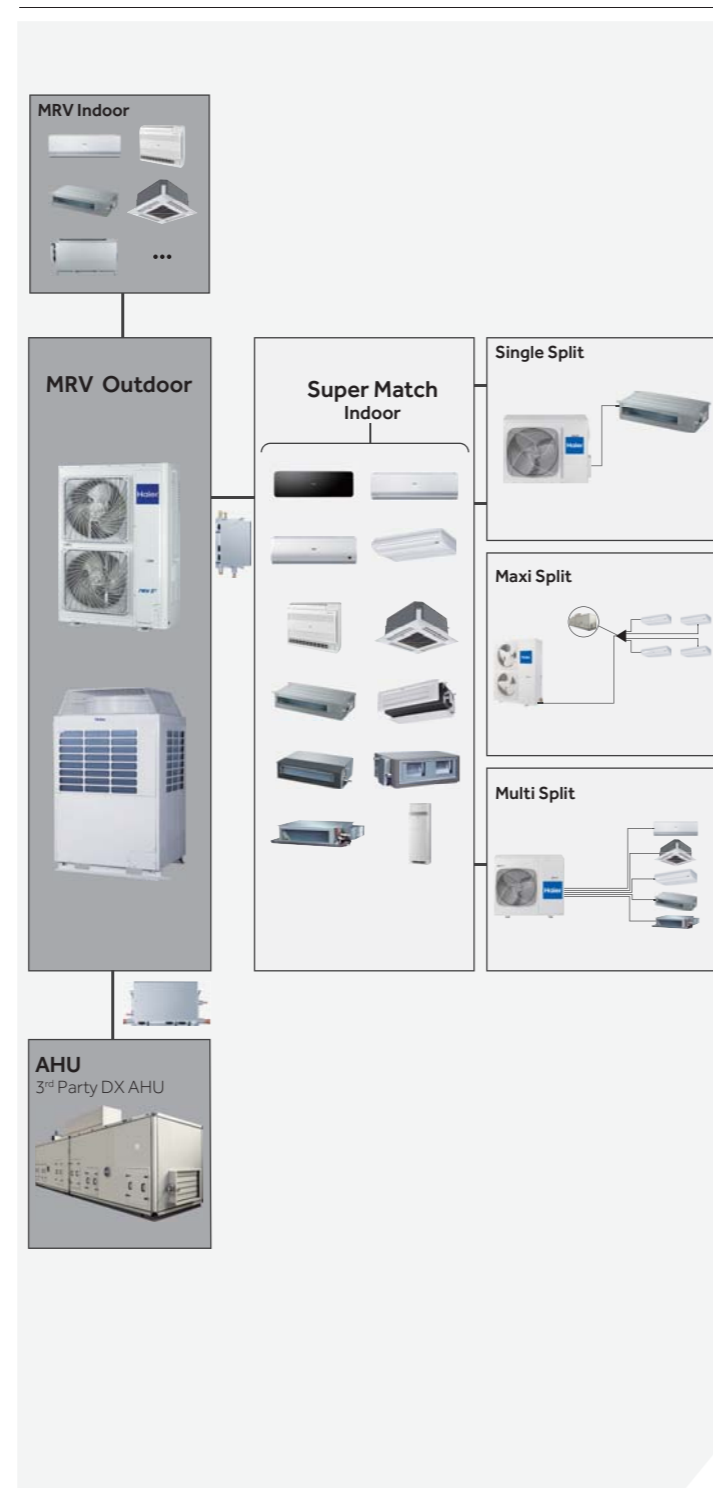

Easy MRV System Introduction

Haier Easy MRV Connection Kit offers a range of expansion valve kits and control boxes to connect Haier SUPER MATCH indoor units.

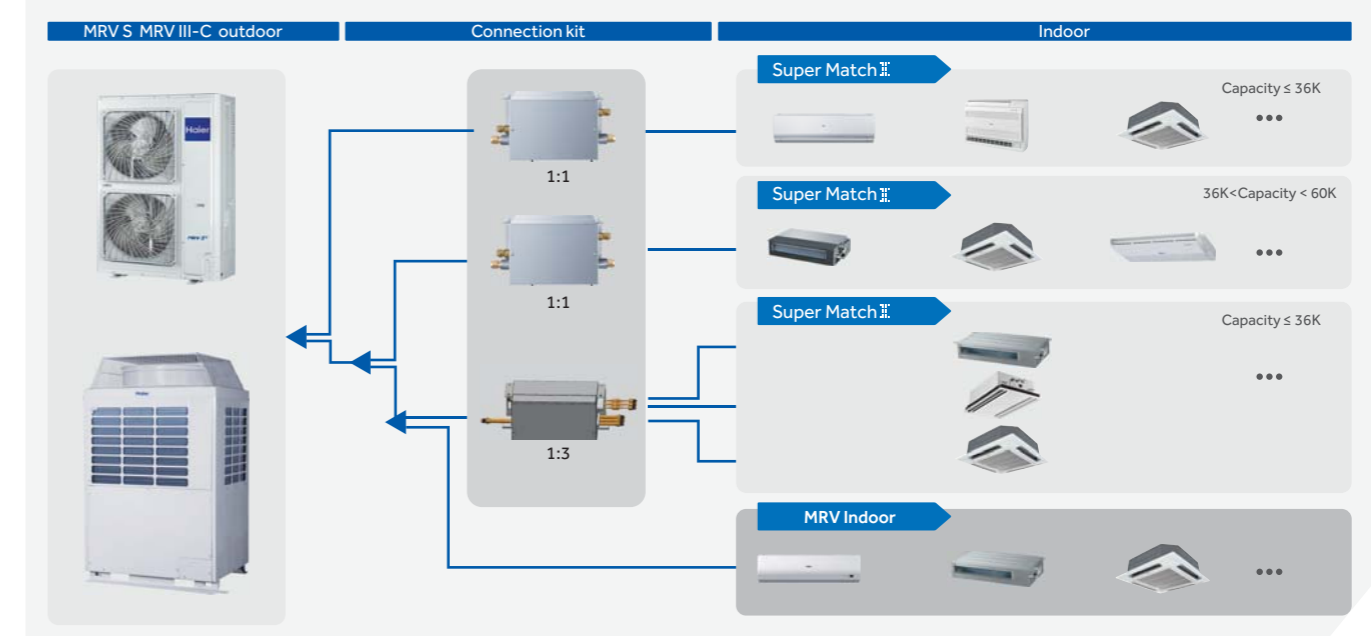

Easy MRV Line up

Haier Easy MRV Provide a wide range of MRV outdoor, valve box and Super Match Indoor solution.



FEATURES & BENEFITS

Valve Box Inner Structure

Haier Easy MRV Connection Kit consists the following 2 parts.

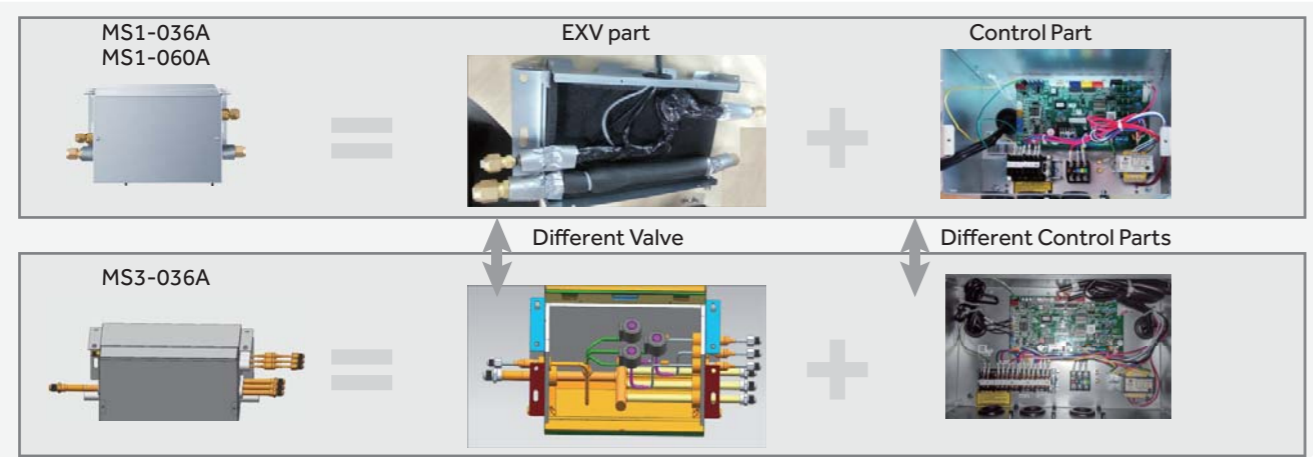



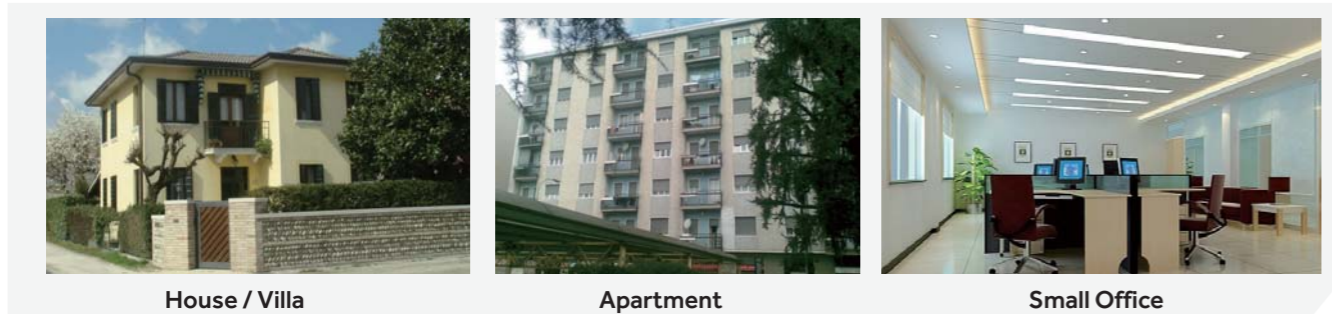

High Compatible

- Provide a new solution with MRV outdoor and Super Match indoor units to dealers/consumers, more compatible, stock reduced.
- Super match new Hi-wall NF, NH unit and console type can be directly connected with MRV outdoor.

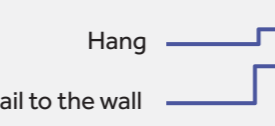

Easy Installation

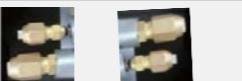
EXV part and Control part integration, easy for translation and installation. Gas pipe is integrated into the valve box.	<p>Gas pipe no need the bend and welding, easy installation.</p> <p>HAIER  Traditional </p>
Optional installation location EEV box inlet and outlet pipe can be left or right.	<p>Installation can choose lifting or nailed to the wall.</p> <p>Hang </p> <p>Nail to the wall </p>
Flare Connection	<p>Different sizes of nut.</p> 

Good performance





Largest Indoor Capacity	Largest Indoor Capacity can be up to 60K ,the largest indoor in the industry for this integrated system
Largest outdoor Capacity	Largest capacity of side discharge up to 12HP for EASY MRV system. Largest capacity of top discharge up to 16HP for Easy MRV system.
Low noise	Outside EEV box, low noise
Good parts	FUJIKOKI EEV, good performance and high reliability

Specification

Model	MS1-036A	MS1-060A	MS3-036A
Connected indoor quantity	1	1	3
Connected indoor capacity(Btu/h)	X ≤36k	36 < X ≤60k	X ≤36k (each indoor)
Power Supply (Ph/V/Hz)	1/220-230/50/60	1/220-230/50/60	1/220-230/50/60
Size(W/D/H)	310/217/155	310/217/155	394/227/253
Shipping dimensions	509/285/209	509/285/209	687/295/303
Material	Galvanized steel	Galvanized steel	Galvanized steel
Color	Grey	Grey	Grey
Weight/kg	5	5	9
Shipping Weight/kg	7	7	12
Liquid pipe (mm)	9.52 (Main) /6.35	9.52 (Main) /12.7	6.35 (Main) /9.52 9.52 (Main) /12.7
Gas pipe (mm)	15.88 (Main) /12.7 /9.52	19.05 (Main) /15.88	19.05 (Main) /15.88 15.88 (Main) /12.7 /9.52
Pipe connection method	Flare connection	Flare connection	Flare connection
Brand box-Indoor Max Single pipe length(m)	15	15	15
Branch box- indoor max drop(m)	15	15	15
Height Drop between branch box (m)	15	15	15











PARAMETERS

Easy MRV Outdoor

OUTDOOR MODEL	MRV S						MRV III-C				
	AU482FIERA(G)	AU48NFIERA(G)	AU60NFIERA(G)	AV08NMSETA	AV10NMSETA	AV12NMSETA	AV08NMVESA	AV10NMVESA	AV12MVESA	AV14MVESA	AV16MVESA
Photo											
HP	5	5	7	8	10	12	8	10	12	14	16
kW	15	15	18	22.6	28	33.5	22.6	28	33.5	40	45
Power supply	1/220-230/50 1/220-230/60	3/380-400/50	3/380-400/60	3/380-400/50	3/380-400/60		3/380-400/50	3/380-400/60	3/208-230/60	3/460/60	

Easy MRV Indoor

Easy MRV indoor is universal indoor unit with Super Match

Super Match I INDOOR	PHOTO	7K 2.2	9K 2.8	12K 3.6	15K 4.4	18K 5.5	24K 7.1	28K 8	36K 10	48K 14	60K 16
AQUA Hi-Wall		AS07QS2HRA	AS09QS2HRA	AS12QS2HRA							
N F series		AS07NS1HRA-WU AS07NS1HRA-GU	AS09NS1HRA-WU AS09NS1HRA-GU	AS12NS1HRA-WU AS12NS1HRA-GU	AS15NS1HRA-GU	AS18NS1HRA-WU AS18NS1HRA-GU	AS24NS1HRA-WU AS24NS1HRA-GU				
NH series		AS07BS4HRA	AS09BS4HRA	AS12BS4HRA	AS15BS4HRA	AS18BS4HRA	AS24BS4HRA				
Zircon Hi-Wall		AS07ZB1HRA	AS09ZB1HRA	AS12ZB1HRA		AS18ZB1HRA	AS24ZB1HRA				
Console			AF09AS1ERA	AF12AS1ERA							
Cassette			AB09CS2ERA(S)	AB12CS2ERA(S)		AB18CS2ERA(S)	AB24ES1ERA(S)	AB28ES1ERA(S)	AB36ES1ERA(S)	AB48ES1ERA(S)	AB60CS1ERA(S)
Convertible			AC12CS1ERA(S)	AC18CS1ERA(S)	AC24CS1ERA(S)			AC28ES1ERA(S)	AC36ES1ERA(S)	AC48FS1ERA(S)	AC60FS1ERA(S)
Slim ESP			AD09SS1ERA	AD12SS1ERA	AD18SS1ERA	AD24SS1ERA					
Low ESP duct			AD09LS1ERA	AD12LS1ERA	AD18LS1ERA	AD24LS1ERA					
Medium ESP duct				AD12MS1ERA		AD18MS1ERA	AD24MS1ERA	AD28NS1ERA(S)	AD36NS1ERA(S)	AD48NS1ERA(S)	
High ESP duct										AD48HS1ERA(S)	AD60HS1ERA(S)

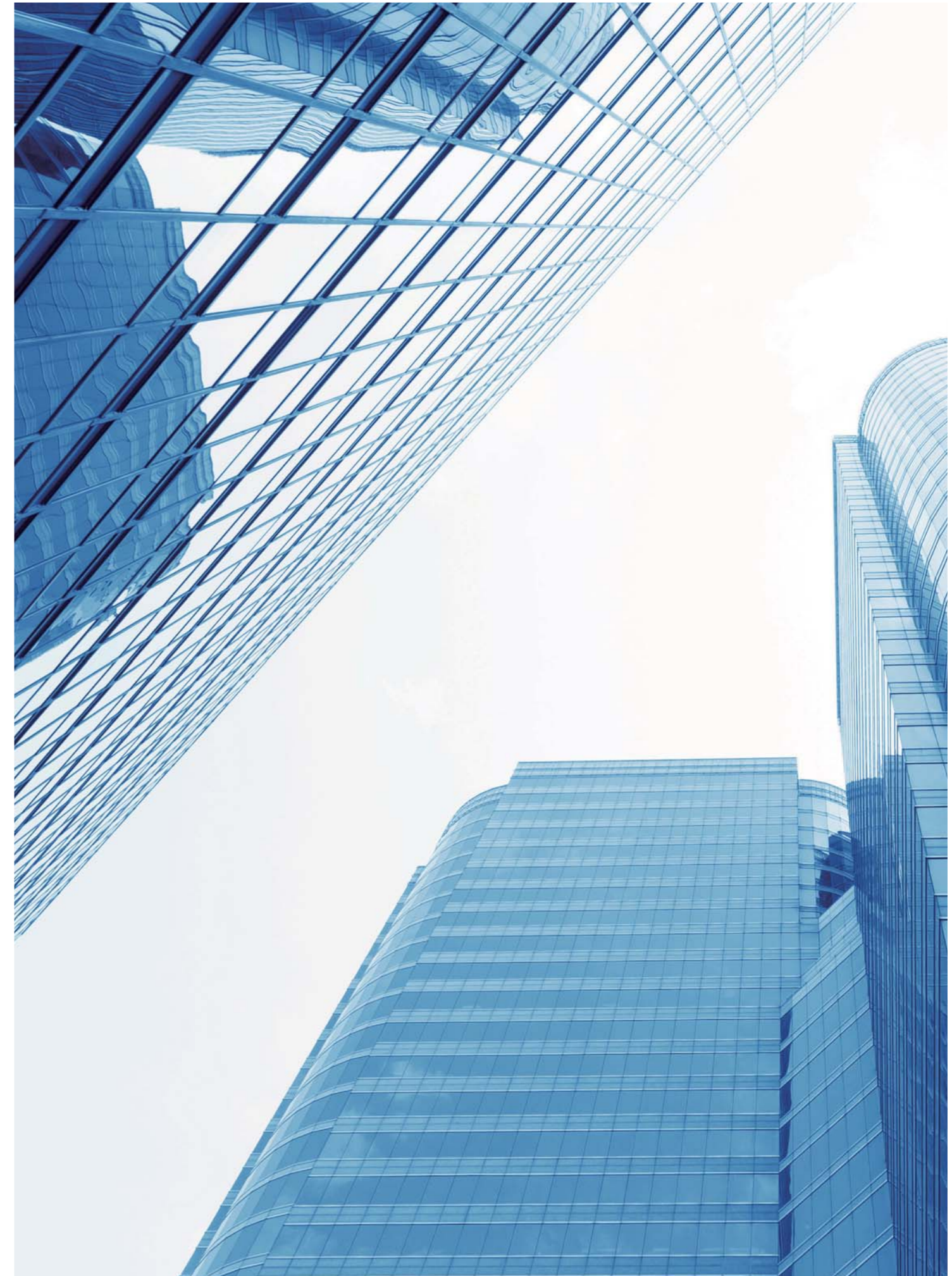



MRV AHU CONNECTION KIT

- | 111 Features & Benefits
- | 115 MRV Outdoor Line Up

FEATURES & BENEFITS

System Introduction

Haier offers a range of connection kit to connect MRV outdoor units to third party DX air handling units.

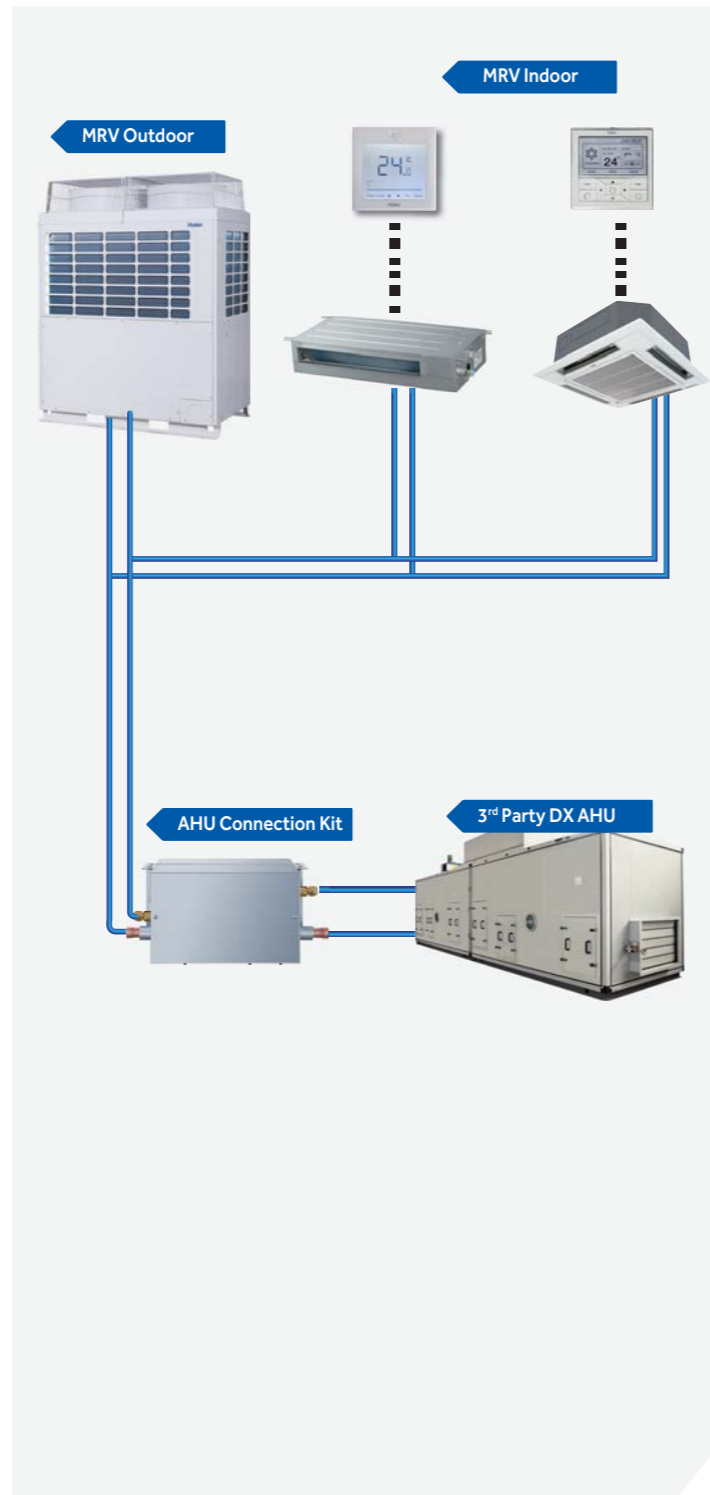

System Application

- Provide a solution for big space to cool down the supply fresh air with MRV outdoor units to match the air handling units. Intergraded the advantages of MRV and AHU units
- Meet the requirement of law in EU, that for every working place it have to supply at minimum 25 m³/h fresh air. so it means that every office, every shop and mostly every commercial building MUST have this solution.

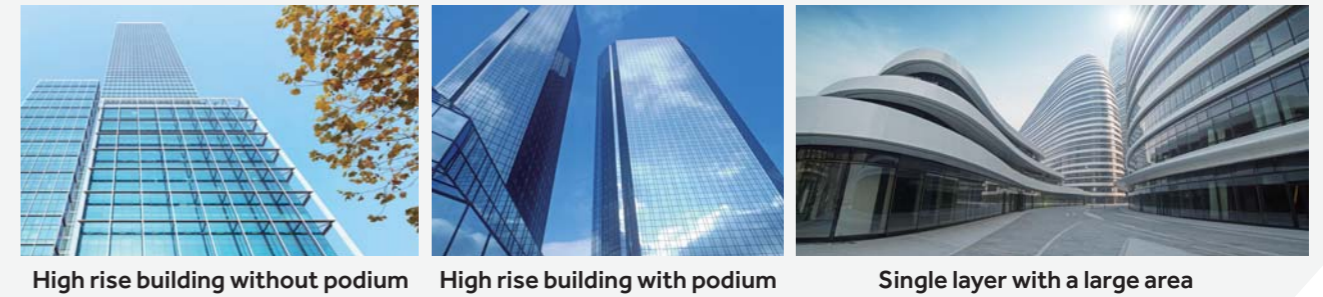

System Line up

Haier Easy MRV Provide a wide range of MRV outdoor, valve box and Super Match Indoor solution.



AHU Kit Configuration

Haier AHU Connection Kit consists the following 4 parts.

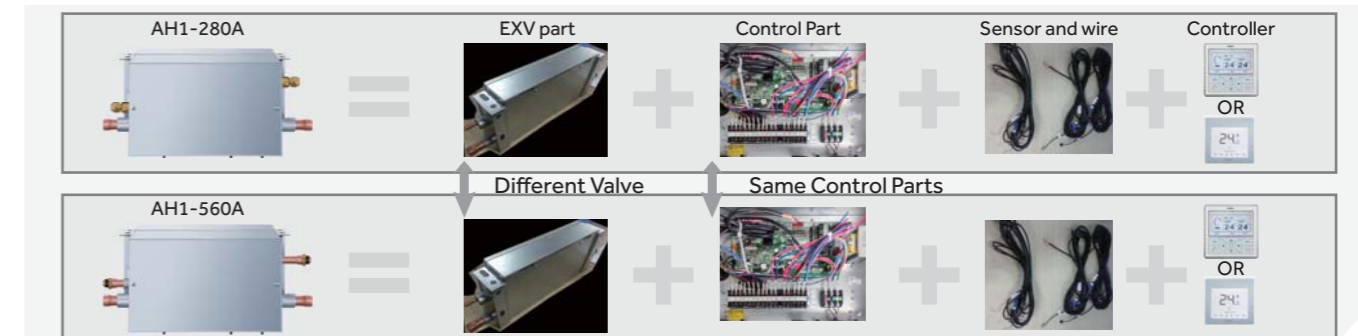

- EXV part, Control part, Sensor and wire are all integrated in one box.
- Controller need to be purchased separately.

FEATURES & BENEFITS

AHU Connection Kit Control

System Control

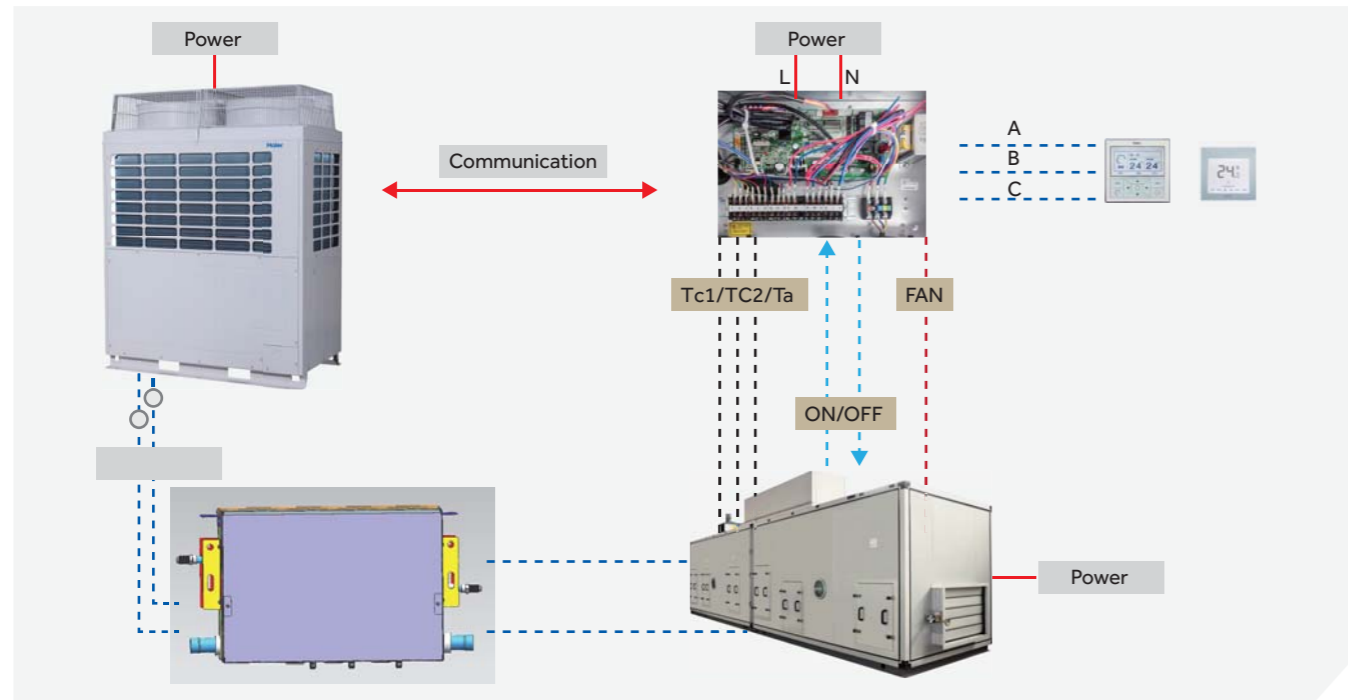

Connection Kit Control

Central Control: AHU control is same as MRV indoor unit control.

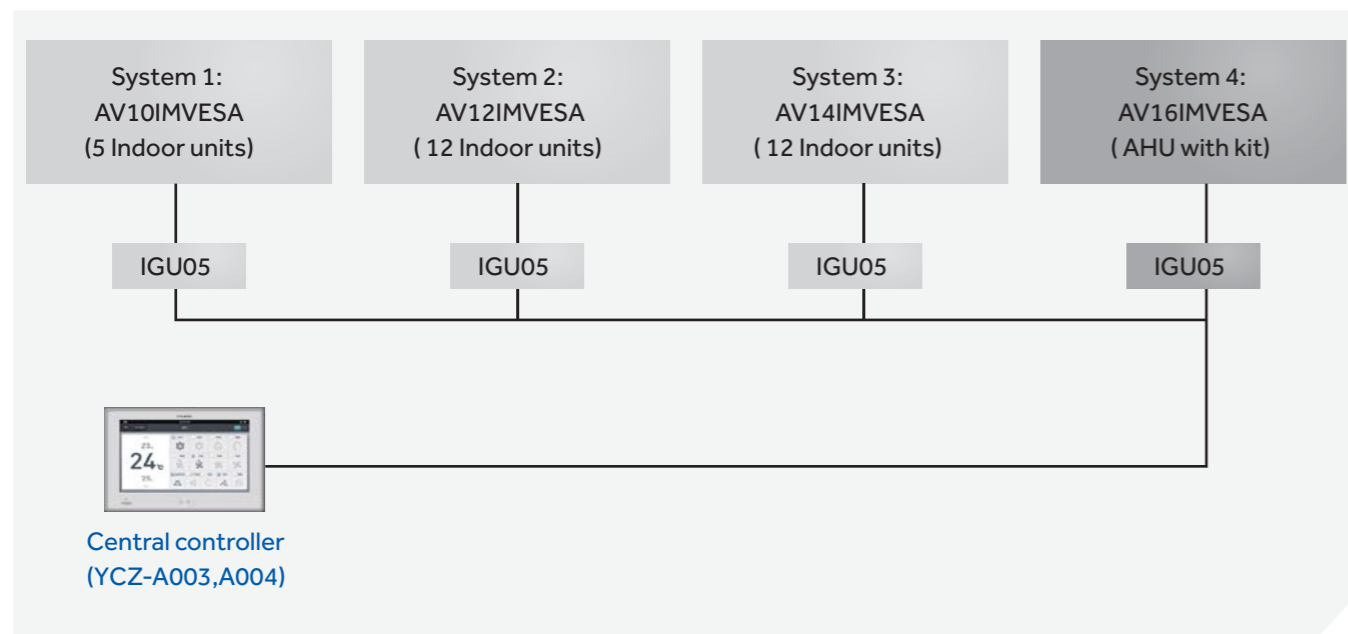

Easy Installation

• Adopting the MRV outdoor, not the traditional chiller outdoor system, is easy to design and install since no additional water system such as boilers, gas connections, cooling tower etc. are required. This also reduces the total system cost.

• AHU can provide enough cooled fresh air to big space other than HRV and fresh air indoor units.

• All the control system for MRV outdoor is available:

- Wired control
- Central control
- Net work control
- BMS control

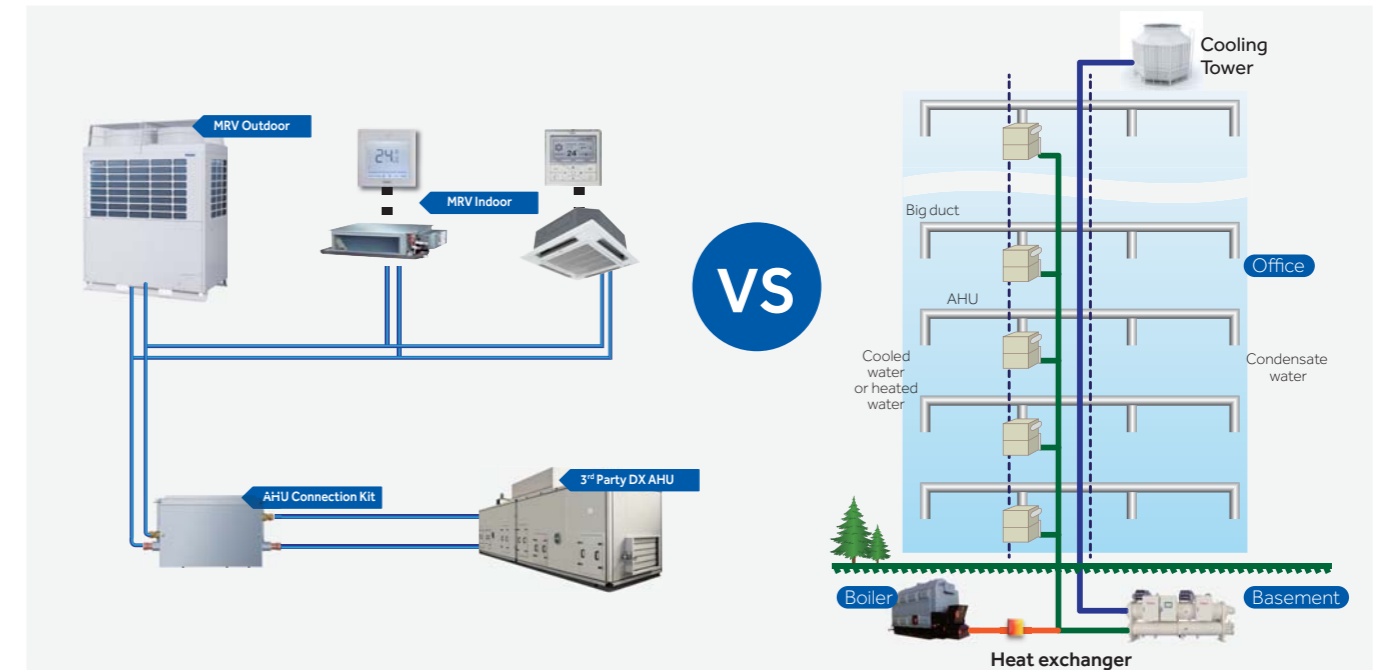

EXV part and Control part integration, easy for translation and installation. Gas pipe is integrated into the valve box.

Gas pipe no need the bend and welding, easy installation.

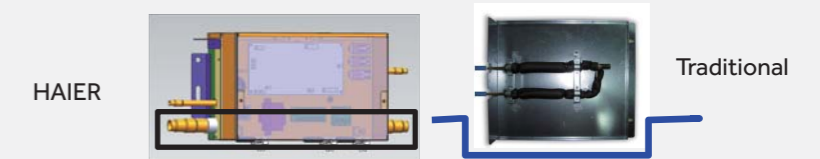

Optional installation location
EEV box inlet and outlet pipe can be left or right.

Installation can choose lifting or nailed to the wall.

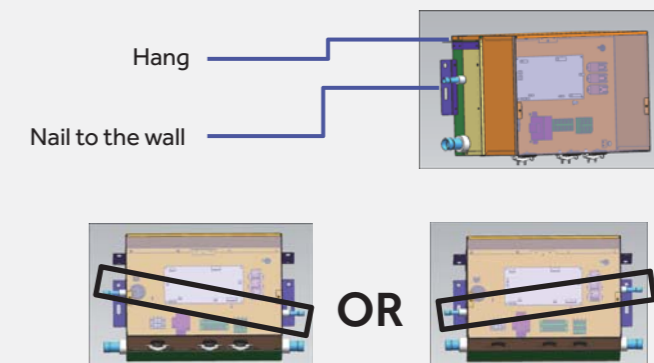

FEATURES & BENEFITS

Advantages

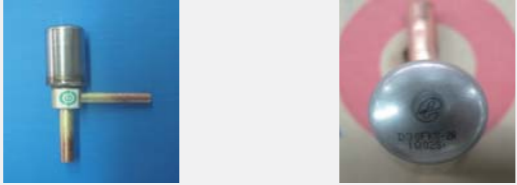

Broad capacity	Connected AHU capacity from 5HP to 20HP.
High Compatible	<p>1.Same PCB board with MRV indoor, easy operation and service.</p> <p>2.Same wired controller can be used with MRV indoor unit such as YR-E16,YR-E17 and YR-E14.</p>
Reliable EEV	<p>EEV is supplied by FUJIKOKI.</p> 

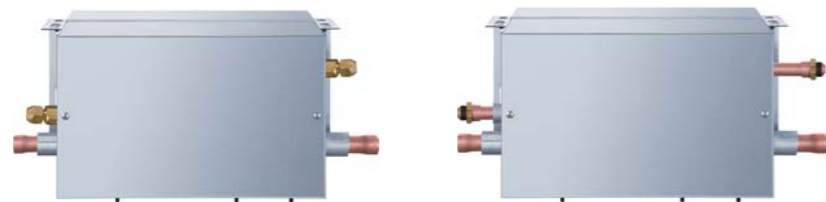
Specification



Model	AH1-280A	AH1-560A
Connected AHU capacity	14≤x ≤28kW(5-10HP)	28<x ≤56kW(10-20HP)
Power Supply (Ph/V/Hz)	1/220-230/50/60	1/220-230/50/60
Dimension(W/D/H)	350/226/155	433/296/193
Shipping dimensions	606*295*209	667*365*249
Material	Galvanized steel	Galvanized steel
Color	Grey	Grey
Weight/kg	6	9
Shipping Weight/kg	8	12
Liquid pipe (mm)	9.52 (Main) /12.7	12.7 (Main) /15.88
Gas pipe (mm)	25.4 (Main) /22.2 /19.05	28.58 (Main) /25.4/22.22
Pipe connection method	Flare connection and welding	Flare connection and welding
Brand box-Indoor Max Single pipe length/m	5	5
Branch box- indoor max drop/m	5	5

MRV OUTDOOR LINE UP

OUTDOOR MODEL	MRV S			MRV III-C				
	AV08NMSETA	AV10NMSETA	AV12NMSETA	AV08MVEVA AV08GMVEVA	AV10MVEVA AV10GMVEVA	AV12MVEVA AV12GMVEVA	AV14MVEVA AV14GMVEVA	AV16MVEVA AV16GMVEVA
								
HP	8	10	12	8	10	12	14	16
kW	22.6	28	33.5	22.6	28	33.5	40	45
Power supply	3/380-400/50 3/380-400/60			3/380-400/50 3/380-400/60 3/208-230/60 3/460/60				





MRV INDOOR

- 119 Round-way Smart Air Flow Cassette
- 121 4-Way Cassette
- 124 2-Way Cassette
- 125 Convertible Type
- 127 Duct Slim Low ESP
- 129 Duct Low ESP (0/20Pa)

- 131 Duct Medium ESP (50/96Pa)
- 133 Duct Medium ESP (80/120Pa)
- 134 Duct High ESP (100/196Pa)
- 137 Built-in Floor Standing
- 138 Console
- 139 High Wall

Round-way Smart Air Flow Cassette

- AB072MRERA**
- AB162MRERA**
- AB092MRERA**
- AB182MRERA**
- AB122MRERA**
- AB242MRERA**



- Unique round-way air outlet, no blind spot
- Innovative 4 independent air flow control
- 6 adjustable louver positions, 1296 air flow combinations
- Move Eye intelligent system, intelligence all around(optional)



Model/Indoor unit			AB072MRERA	AB092MRERA	AB122MRERA	AB162MRERA	AB182MRERA	AB242MRERA
Capacity	Cooling	kBtu/h	7.5	9.5	12.3	15.3	19.1	24.2
		kW	2.2	2.8	3.6	4.5	5.6	7.1
Capacity	Heating	Btu/h	8.5	10.9	13.6	17.1	21.5	27.3
		kW	2.5	3.2	4	5	6.3	8
Electrical Parameters	Power supply	Ph/V/Hz	1/220-230/50/60	1/220-230/50/60	1/220-230/50/60	1/220-230/50/60	1/220-230/50/60	1/220-230/50/60
Performance	Air flow (H)	m³/h	1000	1000	1000	1000	1000	1380
	Sound pressure level(H/M/L)	dB(A)	30/27/25	30/27/25	30/27/25	32/29/27	33/30/29	35/34/31
Installation	External dimensions(W/D/H)	mm	840/840/183	840/840/183	840/840/183	840/840/183	840/840/183	840/840/204
	Shipping dimensions(W/D/H)	mm	983/983/268	983/983/268	983/983/268	983/983/268	983/983/268	983/983/290
	Net/Shipping weight	kg	28/31	28/31	28/31	28/31	28/31	29/32
	Refrigerant liquid pipe	mm	6.35	6.35	6.35	6.35	6.35	9.52
	Refrigerant gas pipe	mm	9.52	9.52	12.7	12.7	12.7	15.88
Panel	Model name		PB-950KB	PB-950KB	PB-950KB	PB-950KB	PB-950KB	PB-950KB
	External dimensions(W/D/H)	mm	950/950/50	950/950/50	950/950/50	950/950/50	950/950/50	950/950/50
	Shipping dimensions(W/D/H)	mm	1013/1025/123	1013/1025/123	1013/1025/123	1013/1025/123	1013/1025/123	1013/1025/123
	Net/Shipping weight	kg	6.5/9	6.5/9	6.5/9	6.5/9	6.5/9	6.5/9
Controller	Wired (O-Optional/S-Standard)	/	YR-E17(S)	YR-E17(S)	YR-E17(S)	YR-E17(S)	YR-E17(S)	YR-E17(S)
	Infrared(O-Optional/S-Standard)	/	YR-HBS01(O)	YR-HBS01(O)	YR-HBS01(O)	YR-HBS01(O)	YR-HBS01(O)	YR-HBS01(O)

Round-way Smart Air Flow Cassette

- AB282MRERA**
- AB482MRERA**
- AB302MRERA**
- AB602MRERA**
- AB382MRERA**





- Unique round-way air outlet, no blind spot
- Innovative 4 independent air flow control
- 6 adjustable louver positions, 1296 air flow combinations
- Move Eye intelligent system, intelligence all around(optional)



Model/Indoor unit			AB282MRERA	AB302MRERA	AB382MRERA	AB482MRERA	AB602MRERA
Capacity	Cooling	kBtu/h	27.3	30.7	38.2	47.7	54.6
		kW	8	9	11.2	14	16
Capacity	Heating	Btu/h	30.7	34.1	42.6	54.6	61.2
		kW	9	10	12.5	16	18
Electrical Parameters	Power supply	Ph/V/Hz	1/220-230/50/60	1/220-230/50/60	1/220-230/50/60	1/220-230/50/60	1/220-230/50/60
Performance	Air flow (H)	m³/h	1380	2050	2050	2100	2100
	Sound pressure level(H/M/L)	dB(A)	37/35/31	37/35/31	37/35/31	44/40/36	44/40/36
Installation	External dimensions(W/D/H)	mm	840/840/204	840/840/246	840/840/246	840/840/288	840/840/288
	Shipping dimensions(W/D/H)	mm	983/983/290	983/983/331	983/983/331	983/983/373	983/983/373
	Net/Shipping weight	kg	29/32	34/37	34/37	35/38	35/38
	Refrigerant liquid pipe	mm	9.52	9.52	9.52	9.52	9.52
	Refrigerant gas pipe	mm	15.88	15.88	15.88	15.88	15.88
Panel	Model name		PB-950KB	PB-950KB	PB-950KB	PB-950KB	PB-950KB
	External dimensions(W/D/H)	mm	950/950/50	950/950/50	950/950/50	950/950/50	950/950/50
	Shipping dimensions(W/D/H)	mm	1013/1025/123	1013/1025/123	1013/1025/123	1013/1025/123	1013/1025/123
	Net/Shipping weight	kg	6.5/9	6.5/9	6.5/9	6.5/9	6.5/9
Controller	Wired (O-Optional/S-Standard)	/	YR-E17(S)	YR-E17(S)	YR-E17(S)	YR-E17(S)	YR-E17(S)
	Infrared(O-Optional/S-Standard)	/	YR-HBS01(O)	YR-HBS01(O)	YR-HBS01(O)	YR-HBS01(O)	YR-HBS01(O)

4-WAY CASSETTE

-  **AB092MCERA**
-  **AB122MCERA**
-  **AB162MCERA**





YR-E17(S) YR-HD(O) YR-E16A(O)

- 700x700mm new panel design
- Pre-set fresh air inlet
- Built-in high head drain pump
- Quiet operation



Model/Indoor unit			AB092MCERA	AB122MCERA	AB162MCERA
Capacity	Cooling	kBtu/h	9.5	12.3	15.3
		kW	2.8	3.6	4.5
Capacity	Heating	Btu/h	10.9	13.6	17.1
		kW	3.2	4	5
Electrical Parameters	Power supply	Ph/V/Hz	1/220-230/50/60	1/220-230/50/60	1/220-230/50/60
Performance	Air flow (H)	m ³ /h	700	700	700
	Sound pressure level(H/M/L)	dB(A)	32/30/29	32/30/29	33/30/29
	Sound power level(H/M/L)	dB(A)	46/44/43	46/44/43	47/44/43
Installation	External dimensions(W/D/H)	mm	570/570/260	570/570/260	570/570/260
	Shipping dimensions(W/D/H)	mm	718/680/380	718/680/380	718/680/380
	Net/Shipping weight	kg	17/21	19/23	19/23
	Refrigerant liquid pipe	mm	6.35	6.35	6.35
	Refrigerant gas pipe	mm	9.52	12.7	12.7
Panel	Model name		PB-700IB	PB-700IB	PB-700IB
	External dimensions(W/D/H)	mm	700/700/60	700/700/60	700/700/60
	Shipping dimensions(W/D/H)	mm	740/740/115	740/740/115	740/740/115
	Net/Shipping weight	kg	2.8/4.5	2.8/4.5	2.8/4.5
Controller	Wired (O-Optional/S-Standard)	/	YR-E16A(O)	YR-E16A(O)	YR-E16A(O)
		/	YR-E16(O)	YR-E16(O)	YR-E16(O)
	Infrared(O-Optional/S-Standard)	/	YR-E17(S)	YR-E17(S)	YR-E17(S)
			YR-HD(O)	YR-HD(O)	YR-HD(O)

4-WAY CASSETTE

-  **AB182MCERA**
-  **AB242MCERA**
-  **AB282MCERA**





YR-E17(S) YR-HD(O) YR-E16A(O)

- Compact design
- Pre-set fresh air inlet
- Built-in high head drain pump
- Reserve branch outlet



Model/Indoor unit			AB182MCERA	AB242MCERA	AB282MCERA
Capacity	Cooling	kBtu/h	19.1	24.2	27.3
		kW	5.6	7.1	8
Capacity	Heating	Btu/h	21.5	27.3	30.7
		kW	6.3	8	9
Electrical Parameters	Power supply	Ph/V/Hz	1/220-230/50/60	1/220-230/50/60	1/220-230/50/60
Performance	Air flow (H)	m ³ /h	1200	1200	1200
	Sound pressure level(H/M/L)	dB(A)	34/32/30	35/34/31	37/35/31
	Sound power level(H/M/L)	dB(A)	48/46/44	49/48/45	51/49/45
Installation	External dimensions(W/D/H)	mm	840/840/240	840/840/240	840/840/240
	Shipping dimensions(W/D/H)	mm	930/930/330	930/930/330	930/930/330
	Net/Shipping weight	kg	30/32.5	30/32.5	30/32.5
	Refrigerant liquid pipe	mm	6.35	9.52	9.52
	Refrigerant gas pipe	mm	12.7	15.88	15.88
Panel	Model name		PB-950JB	PB-950JB	PB-950JB
	External dimensions(W/D/H)	mm	950/950/60	950/950/60	950/950/60
	Shipping dimensions(W/D/H)	mm	992/992/115	992/992/115	992/992/115
	Net/Shipping weight	kg	6/7.5	6/7.5	6/7.5
Controller	Wired (O-Optional/S-Standard)	/	YR-E16A(O)	YR-E16A(O)	YR-E16A(O)
		/	YR-E16(O)	YR-E16(O)	YR-E16(O)
	Infrared(O-Optional/S-Standard)	/	YR-E17(S)	YR-E17(S)	YR-E17(S)
			YR-HD(O)	YR-HD(O)	YR-HD(O)

4-WAY CASSETTE

-  **AB302MCERA**
-  **AB382MCERA**
-  **AB482MCERA**



- Compact design
- Pre-set fresh air inlet
- Built-in high head drain pump
- Reserve branch outlet



Model/Indoor unit			AB302MCERA	AB382MCERA	AB482MCERA
Capacity	Cooling	kBtu/h	30.7	38.2	47.7
		kW	9	11.2	14
	Heating	Btu/h	34.1	42.6	54.6
		kW	10	12.5	16
Electrical Parameters	Power supply	Ph/V/Hz	1/220-230/50/60	1/220-230/50/60	1/220-230/50/60
	Air flow (H)	m³/h	1800	1800	1800
Performance	Sound pressure level(H/M/L)	dB(A)	37/35/31	37/35/31	42/39/35
	Sound power level(H/M/L)	dB(A)	51/49/45	51/49/45	56/53/49
	Installation	External dimensions(W/D/H)	mm	840/840/295	840/840/295
Shipping dimensions(W/D/H)		mm	930/930/390	930/930/390	930/930/390
Net/Shipping weight		kg	38/40	38/40	38/40
Refrigerant liquid pipe		mm	9.52	9.52	9.52
Refrigerant gas pipe		mm	15.88	15.88	15.88
Panel	Model name		PB-950JB	PB-950JB	PB-950JB
	External dimensions(W/D/H)	mm	950/950/60	950/950/60	950/950/60
	Shipping dimensions(W/D/H)	mm	992/992/115	992/992/115	985/985/115
	Net/Shipping weight	kg	6/7.5	6/7.5	6/7.5
Controller	Wired (O-Optional/S-Standard)	/	YR-E16A(O)	YR-E16A(O)	YR-E16A(O)
		/	YR-E16(O)	YR-E16(O)	YR-E16(O)
	Infrared(O-Optional/S-Standard)	/	YR-E17(S)	YR-E17(S)	YR-E17(S)
			YR-HD(O)	YR-HD(O)	YR-HD(O)

2-WAY CASSETTE

-  **AB072MBERA**
-  **AB092MBERA**
-  **AB122MBERA**
-  **AB162MBERA**
-  **AB182MBERA**







- Compact design: only 220mm height
- Built in high head drain pump
- Ceiling antifouling design unique antifouling design
- Quiet operation



Model/Indoor unit			AB072MBERA	AB092MBERA	AB122MBERA	AB162MBERA	AB182MBERA
Capacity	Cooling	kBtu/h	7.5	9.6	12.3	15.4	19.1
		kW	2.2	2.8	3.6	4.5	5.6
	Heating	Btu/h	8.5	10.9	13.7	17.1	21.5
		kW	2.5	3.2	4	5	6.3
Electrical Parameters	Power supply	Ph/V/Hz	1/220-230/50/60	1/220-230/50/60	1/220-230/50/60	1/220-230/50/60	1/220-230/50/60
	Air flow (H)	m³/h	840	840	840	840	840
Performance	Sound pressure level(H/M/L)	dB(A)	42/37/33	42/37/33	42/37/33	44/39/34	44/39/34
	Sound power level(H/M/L)	dB(A)	55/50/46	55/50/46	55/50/46	57/52/47	57/52/47
	Installation	External dimensions(W/D/H)	mm	817/620/220	817/620/220	817/620/220	817/620/220
Shipping dimensions(W/D/H)		mm	1022×682×274	1022×682×274	1022×682×274	1022×682×274	1022×682×274
Net/Shipping weight		kg	21/23	21/23	21/23	21/23	21/23
Refrigerant liquid pipe		mm	6.35	6.35	6.35	6.35	6.35
Refrigerant gas pipe		mm	9.52	9.52	12.7	12.7	12.7
Panel	Model name		P2B-1055IB	P2B-1055IB	P2B-1055IB	P2B-1055IB	P2B-1055IB
	External dimensions(W/D/H)	mm	1055/680/68	1055/680/68	1055/680/68	1055/680/68	1055/680/68
	Shipping dimensions(W/D/H)	mm	1097×707×136	1097×707×136	1097×707×136	1097×707/136	1097×707×136
	Net/Shipping weight	kg	7/8	7/8	7/8	7/8	7/8
Controller	Wired (O-Optional/S-Standard)	/	YR-E16A(O)	YR-E16A(O)	YR-E16A(O)	YR-E16A(O)	YR-E16A(O)
		/	YR-E16(O)	YR-E16(O)	YR-E16(O)	YR-E16(O)	YR-E16(O)
	Infrared(O-Optional/S-Standard)	/	YR-E17(S)	YR-E17(S)	YR-E17(S)	YR-E17(S)	YR-E17(S)
			YR-HD(O)	YR-HD(O)	YR-HD(O)	YR-HD(O)	YR-HD(O)





CONVERTIBLE

-  AC092MCERA
-  AC122MCERA
-  AC162MCERA
-  AC182MCERA
-  AC242MCERA



- Flexible installation, on the floor or on the ceiling
- Ultra thin design, only 199mm thick
- Automatic horizontal and vertical swing
- Reserved fresh air inlet

CONVERTIBLE

-  AC282MFERA
-  AC302MFERA
-  AC382MFERA
-  AC482MFERA



- Flexible installation, on the floor or on the ceiling
- Automatic horizontal and vertical swing
- Reserved fresh air inlet
- Multiple direction for connection pipe setting
- Long-life and high efficiency air purify filter







Model/Indoor unit			AC092MCERA	AC122MCERA	AC162MCERA	AC182MCERA	AC242MCERA
Capacity	Cooling	kBtu/h	9.5	12.3	15.4	19.1	24.2
		kW	2.8	3.6	4.5	5.6	7.1
	Heating	Btu/h	10.9	13.6	17.1	21.5	27.3
		kW	3.2	4	5	6.3	8
Electrical Parameters	Power supply	Ph/V/Hz	1/220-230/50/60	1/220-230/50/60	1/220-230/50/60	1/220-230/50/60	1/220-230/50/60
	Air flow (H)	m³/h	800	800	800	800	800
Performance	Sound pressure level(H/M/L)	dB(A)	38/35/33	38/35/33	40/37/35	40/37/35	40/37/35
	Sound power level(H/M/L)	dB(A)	51/48/46	51/48/46	53/50/48	53/50/48	53/50/48
	External dimensions(W/D/H)	mm	990/655/199	990/655/199	990/655/199	990/655/199	990/655/199
Installation	Shipping dimensions(W/D/H)	mm	1160/730/280	1160/730/280	1160/730/280	1160/730/280	1160/730/280
	Net/Shipping weight	kg	28.3/34.3	28.3/36.4	28.3/36.4	28.3/36.4	28.3/36.4
	Refrigerant liquid pipe	mm	6.35	6.35	6.35	6.35	9.52
	Refrigerant gas pipe	mm	9.52	12.7	12.7	12.7	15.88
	Controller	Wired (O-Optional/S-Standard)	/	YR-E16A(O)	YR-E16A(O)	YR-E16A(O)	YR-E16A(O)
		/	YR-E16(O)	YR-E16(O)	YR-E16(O)	YR-E16(O)	YR-E16(O)
		/	YR-E17(S)	YR-E17(S)	YR-E17(S)	YR-E17(S)	YR-E17(S)
	Infrared(O-Optional/S-Standard)		YR-HD(O)	YR-HD(O)	YR-HD(O)	YR-HD(O)	YR-HD(O)



Model/Indoor unit			AC282MFERA	AC302MFERA	AC382MFERA	AC482MFERA
Capacity	Cooling	kBtu/h	27.3	30.7	38.2	48
		kW	8	9	11.2	14
	Heating	Btu/h	30.7	34.1	42.6	55
		kW	9	10	12.5	16
Electrical Parameters	Power supply	Ph/V/Hz	1/220-230/50/60	1/220-230/50/60	1/220-230/50/60	1/220-230/50/60
	Air flow (H)	m³/h	2040	2040	2040	2040
Performance	Sound pressure level(H/M/L)	dB(A)	43/40/38	43/40/38	46/42/38	46/42/38
	Sound power level(H/M/L)	dB(A)	56/53/51	56/53/51	59/55/51	59/55/51
	External dimensions(W/D/H)	mm	1580/700/240	1580/700/240	1580/700/240	1580/700/240
Installation	Shipping dimensions(W/D/H)	mm	1720/800/330	1720/800/330	1720/800/330	1720/800/330
	Net/Shipping weight	kg	50/57	50/57	54/61	54/61
	Refrigerant liquid pipe	mm	9.52	9.52	9.52	9.52
	Refrigerant gas pipe	mm	15.88	15.88	15.88	15.88
	Controller	Wired (O-Optional/S-Standard)	/	YR-E16A(O)	YR-E16A(O)	YR-E16A(O)
		/	YR-E16(O)	YR-E16(O)	YR-E16(O)	YR-E16(O)
		/	YR-E17(S)	YR-E17(S)	YR-E17(S)	YR-E17(S)
	Infrared(O-Optional/S-Standard)		YR-HD(O)	YR-HD(O)	YR-HD(O)	YR-HD(O)

DUCT SLIM LOW ESP



-  AD072MSERA
-  AD092MSERA
-  AD122MSERA
-  AD162MSERA



YR-E17(S) YR-HD(O) YR-E16A(O)

- Super slim design, only 185mm
- Reserved fresh air inlet
- Built-in high head drain pump
- Friendly design of rear or bottom air return
- Quiet operation
- Static pressure 0/30Pa

DUCT SLIM LOW ESP

-  AD182MSERA
-  AD242MSERA

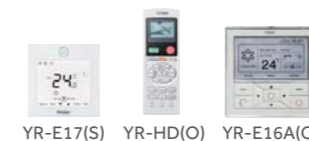

YR-E17(S) YR-HD(O) YR-E16A(O)

- Super slim design, only 185mm
- Reserved fresh air inlet
- Built-in high head drain pump
- Friendly design of rear or bottom air return
- Quiet operation
- Static pressure 0/30Pa

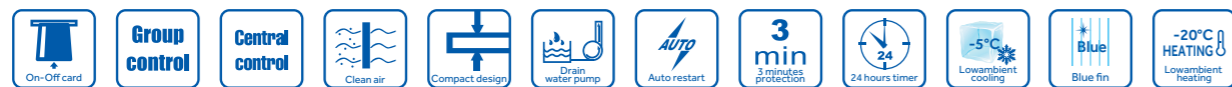

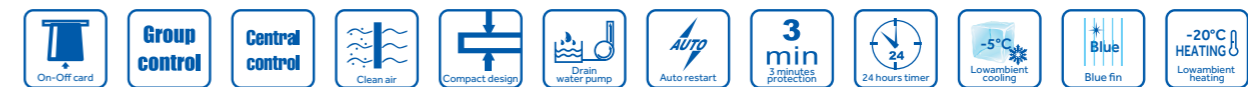

Model/Indoor unit			AD072MSERA	AD092MSERA	AD122MSERA	AD162MSERA
Capacity	Cooling	kBtu/h	7.5	9.5	12.3	15.3
		kW	2.2	2.8	3.6	4.5
	Heating	Btu/h	8.5	10.9	13.6	17.1
		kW	2.5	3.2	4	5
Electrical Parameters	Power supply	Ph/V/Hz	1/220-230/50/60	1/220-230/50/60	1/220-230/50/60	1/220-230/50/60
	Air flow (H)	m³/h	480	480	550	600
Performance	Sound pressure level(H/M/L)	dB(A)	27/24/21	27/24/21	30/28/25	33/30/27
	Sound power level(H/M/L)	dB(A)	41/38/35	41/38/35	44/42/39	47/44/41
Installation	External dimensions(W/D/H)	mm	850/420/185	850/420/185	850/420/185	850/420/185
	Shipping dimensions(W/D/H)	mm	1045/540/270	1045/540/270	1045/540/270	1045/540/270
	Net/Shipping weight	kg	16.5/21.5	16.5/21.5	17.5/22.5	18.5/23.5
	Refrigerant liquid pipe	mm	6.35	6.35	6.35	6.35
	Refrigerant gas pipe	mm	9.52	9.52	12.7	12.7
Drain pump	Static pressure	Pa	0/30	0/30	0/30	0/30
Controller	S-standard		S	S	S	S
	Wired (O-Optional/S-Standard)	/	YR-E16A(O)	YR-E16A(O)	YR-E16A(O)	YR-E16A(O)
		/	YR-E16(O)	YR-E16(O)	YR-E16(O)	YR-E16(O)
		/	YR-E17(S)	YR-E17(S)	YR-E17(S)	YR-E17(S)
Infrared(O-Optional/S-Standard)	/	YR-HD(O)	YR-HD(O)	YR-HD(O)	YR-HD(O)	



Model/Indoor unit			AD182MSERA	AD242MSERA
Capacity	Cooling	kBtu/h	19.1	24.2
		kW	5.6	7.1
	Heating	Btu/h	21.5	27.3
		kW	6.3	8
Electrical Parameters	Power supply	Ph/V/Hz	1/220-230/50/60	1/220-230/50/60
	Air flow (H)	m³/h	800	930
Performance	Sound pressure level(H/M/L)	dB(A)	33/30/28	36/33/31
	Sound power level(H/M/L)	dB(A)	47/44/42	50/47/44
Installation	External dimensions(W/D/H)	mm	1170/420/185	1170/420/185
	Shipping dimensions(W/D/H)	mm	1365/540/270	1365/540/270
	Net/Shipping weight	kg	22.2/28.2	24/30
	Refrigerant liquid pipe	mm	6.35	9.52
	Refrigerant gas pipe	mm	12.7	15.88
Drain Pump	Static Pressure	Pa	0/30	0/30
Controller	S-standard		S	S
	Wired (O-Optional/S-Standard)	/	YR-E16A(O)	YR-E16A(O)
		/	YR-E16(O)	YR-E16(O)
		/	YR-E17(S)	YR-E17(S)
Infrared(O-Optional/S-Standard)	/	YR-HD(O)	YR-HD(O)	

DUCT LOW ESP

-  **AD072MLERA**
-  **AD092MLERA**
-  **AD122MLERA**





- Ultra thin design, only 220mm
- Knock-down drain pan
- Two-way pipe connection
- Left or right side drain outlet
- Static pressure 0/20Pa



Model/Indoor unit			AD072MLERA	AD092MLERA	AD122MLERA
Capacity	Cooling	kBtu/h	7.5	9.5	12.3
		kW	2.2	2.8	3.6
Capacity	Heating	Btu/h	8.5	10.9	13.6
		kW	2.5	3.2	4
Electrical Parameters	Power supply	Ph/V/Hz	1/220-230/50/60	1/220-230/50/60	1/220-230/50/60
Performance	Air flow (H)	m³/h	400	400	500
	Sound pressure level(H/M/L)	dB(A)	35/32/30	35/32/30	35/32/30
	Sound power level(H/M/L)	dB(A)	49/46/44	49/46/44	49/46/44
Installation	External dimensions(W/D/H)	mm	610/500/220	610/500/220	610/500/220
	Shipping dimensions(W/D/H)	mm	710/549/280	710/549/280	710/549/280
	Net/Shipping weight	kg	15/17	15/17	16/18
	Refrigerant liquid pipe	mm	6.35	6.35	6.35
	Refrigerant gas pipe	mm	9.52	9.52	12.7
	Static Pressure(Standard/Max.)	Pa	0/20	0/20	0/20
Drain Pump	O-optional,S-standard,W-without		KT-NP01(Optional)	KT-NP01(Optional)	KT-NP01(Optional)
Controller	Wired (O-Optional/S-Standard)	/	YR-E16A(O)	YR-E16A(O)	YR-E16A(O)
	Infrared(O-Optional/S-Standard)	/	YR-E16(O)	YR-E16(O)	YR-E16(O)
		/	YR-E17(S)	YR-E17(S)	YR-E17(S)
		/	YR-HD(O)	YR-HD(O)	YR-HD(O)

DUCT LOW ESP

-  **AD162MLERA**
-  **AD182MLERA**
-  **AD242MLERA**



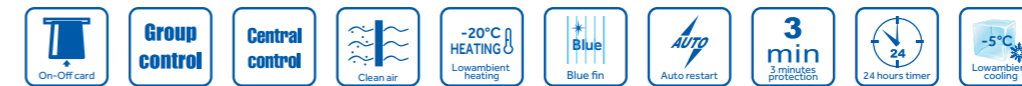

- Ultra thin design, only 220mm
- Knock-down drain pan
- Two-way pipe connection
- Left or right side drain outlet
- Static pressure 0/20Pa



Model/Indoor unit			AD162MLERA	AD182MLERA	AD242MLERA
Capacity	Cooling	kBtu/h	15.3	19.1	24.2
		kW	4.5	5.6	7.1
Capacity	Heating	Btu/h	17.1	21.5	27.3
		kW	5	6.3	8
Electrical Parameters	Power supply	Ph/V/Hz	1/220-230/50/60	1/220-230/50/60	1/220-230/50/60
Performance	Air flow (H)	m³/h	850	1250	1250
	Sound pressure level(H/M/L)	dB(A)	35/32/30	39/37/35	39/37/35
	Sound power level(H/M/L)	dB(A)	49/46/44	53/51/49	53/51/49
Installation	External dimensions(W/D/H)	mm	1105/500/220	1105/500/220	1105/500/220
	Shipping dimensions(W/D/H)	mm	1174/549/294	1174/549/294	1174/549/294
	Net/Shipping weight	kg	25/27	28/30	28/30
	Refrigerant liquid pipe	mm	6.35	6.35	9.52
	Refrigerant gas pipe	mm	12.7	12.7	15.88
	Static Pressure(Standard/Max.)	Pa	0/20	0/20	0/20
Drain Pump	O-optional,S-standard,W-without		KT-NP01(Optional)	KT-NP01(Optional)	KT-NP01(Optional)
Controller	Wired (O-Optional/S-Standard)	/	YR-E16A(O)	YR-E16A(O)	YR-E16A(O)
	Infrared(O-Optional/S-Standard)	/	YR-E16(O)	YR-E16(O)	YR-E16(O)
		/	YR-E17(S)	YR-E17(S)	YR-E17(S)
		/	YR-HD(O)	YR-HD(O)	YR-HD(O)

MRV IV-C
MRV III-C
MRV III-RC
MRV S
MRV W
Easy MRV
MRV AHU
MRV Indoor
Control System
Reference Projects

DUCT MEDIUM ESP

-  AD182MMERA
-  AD242MMERA
-  AD282MMERA





- Flexible duct connection
- Built in drain pump
- Static pressure 50/96Pa



Model/Indoor unit			AD182MMERA	AD242MMERA	AD282MMERA
Capacity	Cooling	kBtu/h	19.1	24.2	27.3
		kW	5.6	7.1	8
	Heating	Btu/h	21.5	27.3	30.7
		kW	6.3	8	9
Electrical Parameters	Power supply	Ph/V/Hz	1/220-230/50/60	1/220-230/50/60	1/220-230/50/60
	Air flow (H)	m³/h	1200	1200	1200
Performance	Sound pressure level(H/M/L)	dB(A)	36/34/31	36/34/31	39/37/35
	Sound power level(H/M/L)	dB(A)	49/47/44	49/47/44	52/50/48
	External dimensions(W/D/H)	mm	990/650/300	990/650/300	990/650/300
Installation	Shipping dimensions(W/D/H)	mm	1170/860/340	1170/860/340	1170/860/340
	Net/Shipping weight	kg	39/45	39/45	39/45
	Refrigerant liquid pipe	mm	6.35	9.52	9.52
	Refrigerant gas pipe	mm	12.7	15.88	15.88
	Static Pressure(Standard/Max.)	Pa	50/96	50/96	50/96
	Drain Pump	O-optional,S-standard,W-without		S	S
Controller	Wired (O-Optional/S-Standard)	/	YR-E16A(O)	YR-E16A(O)	YR-E16A(O)
		/	YR-E16(O)	YR-E16(O)	YR-E16(O)
	Infrared(O-Optional/S-Standard)	/	YR-E17(S)	YR-E17(S)	YR-E17(S)
		/	YR-HD(O)	YR-HD(O)	YR-HD(O)

DUCT MEDIUM ESP

-  AD302MMERA
-  AD382MMERA
-  AD482MMERA



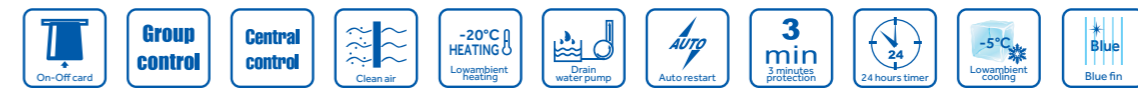

- Flexible duct connection
- Built in drain pump
- Static pressure 50/96Pa



Model/Indoor unit			AD302MMERA	AD382MMERA	AD482MMERA
Capacity	Cooling	kBtu/h	30.7	38.2	47.7
		kW	9	11.2	14
	Heating	Btu/h	34.1	42.6	54.6
		kW	10	12.5	16
Electrical Parameters	Power supply	Ph/V/Hz	1/220-230/50	1/220-230/50	1/220-230/50
	Air flow (H)	m³/h	1900	1900	2100
Performance	Sound pressure level(H/M/L)	dB(A)	39/37/35	41/40/39	41/40/39
	Sound power level(H/M/L)	dB(A)	52/50/48	54/53/52	54/53/52
	External dimensions(W/D/H)	mm	1418/655/350	1418/655/350	1418/655/350
Installation	Shipping dimensions(W/D/H)	mm	1570/813/383	1570/813/383	1570/813/383
	Net/Shipping weight	kg	64/66.7	64/66.7	64/66.7
	Refrigerant liquid pipe	mm	9.52	9.52	9.52
	Refrigerant gas pipe	mm	15.88	15.88	15.88
	Static Pressure(Standard/Max.)	Pa	50/96	50/96	50/96
	Drain Pump	O-optional,S-standard,W-without		S	S
Controller	Wired (O-Optional/S-Standard)	/	YR-E16A(O)	YR-E16A(O)	YR-E16A(O)
		/	YR-E16(O)	YR-E16(O)	YR-E16(O)
	Infrared(O-Optional/S-Standard)	/	YR-E17(S)	YR-E17(S)	YR-E17(S)
		/	YR-HD(O)	YR-HD(O)	YR-HD(O)

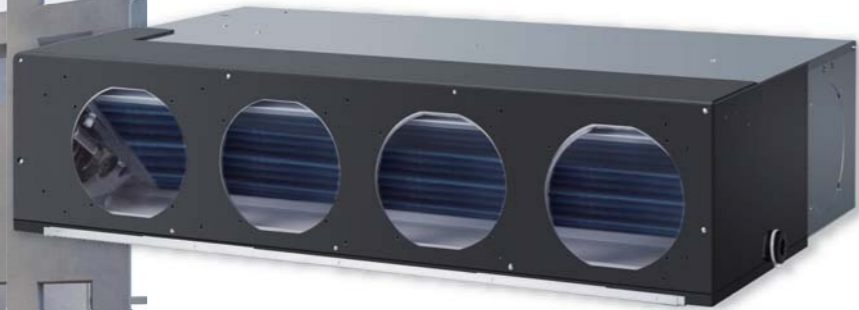

DUCT MEDIUM ESP

-  AD302MNERA
-  AD382MNERA
-  AD482MNERA



- New compact design: 270mm height
- Optional external drain pump
- Flexible duct connection
- Static pressure 80/120Pa

DUCT HIGH ESP

-  AD182MHERA
-  AD242MHERA
-  AD282MHERA



- Flexible duct connection
- Easy to maintain
- Variable static pressure 100/196Pa setting





Model/Indoor unit			AD302MNERA	AD382MNERA	AD482MNERA
Capacity	Cooling	kBtu/h	30	38	48
		kW	9	11.2	14
Capacity	Heating	Btu/h	34	43	55
		kW	10	12.5	16
Electrical Parameters	Power supply	Ph/V/Hz	1/220-230/50/60	1/220-230/50/60	1/220-230/50/60
	Air flow (H)	m³/h	1600	1600	1600
Performance	Sound pressure level(H/M/L)	dB(A)	49/47/43	49/47/43	49/47/43
	Sound power level(H/M/L)	dB(A)	62/60/56	62/60/56	62/60/56
	External dimensions(W/D/H)	mm	1135/742/270	1135/742/270	1135/742/270
Installation	Shipping dimensions(W/D/H)	mm	1355/856/380	1355/856/380	1355/856/380
	Net/Shipping weight	kg	50/56	50/56	50/56
	Refrigerant liquid pipe	mm	9.52	9.52	9.52
	Refrigerant gas pipe	mm	15.88	15.88	15.88
	Static Pressure(Standard/Max.)	Pa	80/120	80/120	80/120
	Drain Pump	O-optional,S-standard,W-without		KT-NP01(Optional)	KT-NP01(Optional)
Controller	Wired (O-Optional/S-Standard)	/	YR-E16A(O)	YR-E16A(O)	YR-E16A(O)
		/	YR-E16(O)	YR-E16(O)	YR-E16(O)
		/	YR-E17(S)	YR-E17(S)	YR-E17(S)
	Infrared(O-Optional/S-Standard)	/	YR-HD(O)	YR-HD(O)	YR-HD(O)



Model/Indoor unit			AD182MHERA	AD242MHERA	AD282MHERA
Capacity	Cooling	kBtu/h	19.1	24.2	27.3
		kW	5.6	7.1	8
Capacity	Heating	Btu/h	21.5	27.3	30.73
		kW	6.3	8	9
Electrical Parameters	Power supply	Ph/V/Hz	1/220-230/50/60	1/220-230/50/60	1/220-230/50/60
	Air flow (H)	m³/h	1500	1500	1500
Performance	Sound pressure level(H/M/L)	dB(A)	42/40	42/40	42/40
	Sound power level(H/M/L)	dB(A)	55/53	55/53	55/53
	External dimensions(W/D/H)	mm	975/876/360	975/875/360	975/875/360
Installation	Shipping dimensions(W/D/H)	mm	1050/945/405	1050/945/405	1050/945/405
	Net/Shipping weight	kg	48/58	48/58	48/58
	Refrigerant liquid pipe	mm	6.35	9.52	9.52
	Refrigerant gas pipe	mm	12.7	15.88	15.88
	Static Pressure(Standard/Max.)	Pa	100/196	100/196	100/196
	Drain Pump	O-optional,S-standard,W-without		KT-NP01(Optional)	KT-NP01(Optional)
Controller	Wired (O-Optional/S-Standard)	/	YR-E16A(O)	YR-E16A(O)	YR-E16A(O)
		/	YR-E16(O)	YR-E16(O)	YR-E16(O)
		/	YR-E17(S)	YR-E17(S)	YR-E17(S)
	Infrared(O-Optional/S-Standard)	/	YR-HD(O)	YR-HD(O)	YR-HD(O)



DUCT HIGH ESP

-  AD302MHERA
-  AD382MHERA
-  AD482MHERA



- Flexible duct connection
- Variable static pressure 100/196Pa setting

DUCT HIGH ESP

-  AD722MHERA
-  AD962MHERA



- Flexible duct connection
- Variable static pressure 100/196Pa setting





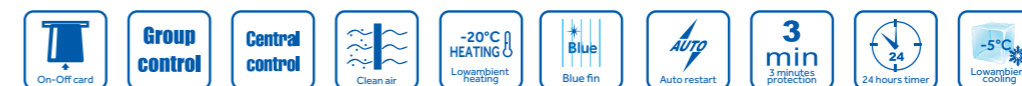



Model/Indoor unit			AD302MHERA	AD382MHERA	AD482MHERA	
Capacity	Cooling	kBtu/h	30.7	38.2	47.8	
		kW	9	11.2	14	
Capacity	Heating	Btu/h	34.1	42.6	54.6	
		kW	10	12.5	16	
Electrical Parameters	Power supply	Ph/V/Hz	1/220-230/50/60	1/220-230/50/60	1/220-230/50/60	
Performance	Air flow (H)	m³/h	1560	1600	2100	
	Sound pressure level(H/M/L)	dB(A)	45/40	45/40	45/40	
	Sound power level(H/M/L)	dB(A)	58/53	58/53	58/53	
Installation	External dimensions(W/D/H)	mm	1355/876/360	1355/876/360	1355/876/360	
	Shipping dimensions(W/D/H)	mm	1386/966/418	1386/966/418	1386/966/418	
	Net/Shipping weight	kg	62/77	62/77	62/77	
	Refrigerant liquid pipe	mm	9.52	9.52	9.52	
	Refrigerant gas pipe	mm	15.88	15.88	15.88	
Drain Pump	Static Pressure(Standard/Max.)	Pa	100/196	100/196	100/196	
Controller	O-optional,S-standard,W-without		KT-NP01(Optional)	KT-NP01(Optional)	KT-NP01(Optional)	
		Wired (O-Optional/S-Standard)	/	YR-E16A(O)	YR-E16A(O)	YR-E16A(O)
			/	YR-E16(O)	YR-E16(O)	YR-E16(O)
			/	YR-E17(S)	YR-E17(S)	YR-E17(S)
		/	YR-HD(O)	YR-HD(O)	YR-HD(O)	



Model/Indoor unit			AD722MHERA	AD962MHERA	
Capacity	Cooling	kBtu/h	77.1	95.6	
		kW	22.6	28	
Capacity	Heating	Btu/h	85.3	105.8	
		kW	25	31	
Electrical Parameters	Power supply	Ph/V/Hz	1/220-230/50/60	1/220-230/50/60	
Performance	Air flow (H)	m³/h	4050	4050	
	Sound pressure level(H/M/L)	dB(A)	54/49	54/49	
	Sound power level(H/M/L)	dB(A)	67/62	67/62	
Installation	External dimensions(W/D/H)	mm	1725/876/360	1725/876/360	
	Shipping dimensions(W/D/H)	mm	1830/990/530	1830/990/530	
	Net/Shipping weight	kg	92/100	92/100	
	Refrigerant liquid pipe	mm	9.52	9.52	
	Refrigerant gas pipe	mm	25.4	25.4	
Drain Pump	Static Pressure(Standard/Max.)	Pa	100/196	100/196	
Controller	O-optional,S-standard,W-without		KT-NP01(Optional)	KT-NP01(Optional)	
		Wired (O-Optional/S-Standard)	/	YR-E16A(O)	YR-E16A(O)
			/	YR-E16(O)	YR-E16(O)
			/	YR-E17(S)	YR-E17(S)
		/	YR-HD(O)	YR-HD(O)	

BUILT-IN FLOOR STANDING





-  **AE072MLERA**
-  **AE092MLERA**
-  **AE122MLERA**
-  **AE162MLERA**
-  **AE182MLERA**
-  **AE242MLERA**



YR-E17(S) YR-HD(O) YR-E16A(O)

- Require very little installation space: only 220mm
- Good solution for installation beneath a window
- High efficiency filter fitted as standard

CONSOLE TYPE

-  **AF072MAERA**
-  **AF092MAERA**
-  **AF122MAERA**
-  **AF182MAERA**



YR-HD(S)

- Air discharge through top and bottom
- Compact design & small space occupation
- Quiet operation

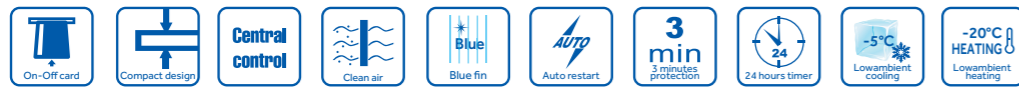







Model/Indoor unit			AE072MLERA	AE092MLERA	AE122MLERA	AE162MLERA	AE182MLERA	AE242MLERA
Capacity	Cooling	kBtu/h	7.5	9.5	12.3	15.3	19.1	24.2
		kW	2.2	2.8	3.6	4.5	5.6	7.1
	Heating	Btu/h	8.5	10.9	13.6	17.1	21.5	27.3
		kW	2.5	3.2	4	5	6.3	8
Electrical Parameters	Power supply	Ph/V/Hz	1/220-230/50/60	1/220-230/50/60	1/220-230/50/60	1/220-230/50/60	1/220-230/50/60	1/220-230/50/60
	Air flow (H)	m³/h	750	750	750	950	950	950
Performance	Sound pressure level(H/M/L)	dB(A)	38/35/33	38/35/33	40/37/35	40/37/35	42/39/36	42/39/36
	Sound power level(H/M/L)	dB(A)	51/48/46	51/48/46	53/50/48	53/50/48	55/52/49	55/52/49
	External dimensions(W/D/H)	mm	1116/221/624	1116/221/624	1116/221/624	1116/221/624	1116/221/624	1116/221/624
Installation	Shipping dimensions(W/D/H)	mm	1198/295/707	1198/295/707	1198/295/707	1198/295/707	1198/295/707	1198/295/707
	Net/Shipping weight	kg	29/37	29/37	29/37	31/39	31/39	31/39
	Refrigerant liquid pipe	mm	6.35	6.35	6.35	6.35	6.35	9.52
	Refrigerant gas pipe	mm	9.52	9.52	12.7	12.7	12.7	15.88
	Static Pressure	Pa	0/30	0/30	0/30	0/30	0/30	0/30
Controller	Wired (O-Optional/S-Standard)	/	YR-E16A(O)	YR-E16A(O)	YR-E16A(O)	YR-E16A(O)	YR-E16A(O)	YR-E16A(O)
		/	YR-E16(O)	YR-E16(O)	YR-E16(O)	YR-E16(O)	YR-E16(O)	YR-E16(O)
	Infrared(O-Optional/S-Standard)	/	YR-E17(S)	YR-E17(S)	YR-E17(S)	YR-E17(S)	YR-E17(S)	YR-E17(S)
		/	YR-HD(O)	YR-HD(O)	YR-HD(O)	YR-HD(O)	YR-HD(O)	YR-HD(O)



Model/Indoor unit			AF072MAERA	AF092MAERA	AF122MAERA	AF182MAERA
Capacity	Cooling	kBtu/h	7.5	9.5	12.3	17
		kW	2.2	2.8	3.6	5.0
	Heating	Btu/h	8.5	10.9	13.6	20.5
		kW	2.5	3.2	4	6
Electrical Parameters	Power supply	Ph/V/Hz	1/220-230/50/60	1/220-230/50/60	1/220-230/50/60	1/220-230/50/60
	Air flow (H)	m³/h	460	460	520	580
Performance	Sound pressure level(H/M/L)	dB(A)	43/39/36	43/39/36	43/39/36	48/46/42
	Sound power level(H/M/L)	dB(A)	56/53/49	56/53/49	56/53/49	61/59/55
	External dimensions(W/D/H)	mm	720/255/640	720/255/640	720/255/640	720/255/640
Installation	Shipping dimensions(W/D/H)	mm	784/305/720	784/305/720	784/305/720	784/305/720
	Net/Shipping weight	kg	18/20	18/20	18/20	18/20
	Refrigerant liquid pipe	mm	6.35	6.35	6.35	6.35
	Refrigerant gas pipe	mm	12.7	12.7	12.7	12.7
	Static Pressure	Pa	0/30	0/30	0/30	0/30
Controller	Wired (O-Optional/S-Standard)	/	/	/	/	/
	Infrared(O-Optional/S-Standard)	/	YR-HD(S)	YR-HD(S)	YR-HD(S)	YR-HD(S)

HIGH WALL

-  **AS072MGERA**
-  **AS092MGERA**
-  **AS122MGERA**
-  **AS162MGERA**
-  **AS182MGERA**
-  **AS242MGERA**



- Stylish design & LED display
- Built in EEV, easy to installation
- Negative ion, vitamin C, and ESF filter optional



Model/Indoor unit		AS072MGERA	AS092MGERA	AS122MGERA	AS162MGERA	AS182MGERA	AS242MGERA
Capacity	Cooling	kBtu/h 2.2	9.5	12.3	15.3	19.1	24.2
	Heating	Btu/h 2.5	10.9	13.6	17.1	21.5	27.3
Electrical Parameters	Power supply	Ph/V/Hz	1/220-230/50/60	1/220-230/50/60	1/220-230/50/60	1/220-230/50/60	1/220-230/50/60
	Air flow (H)	m³/h	600	600	600	600	800
Performance	Sound pressure level(H/M/L)	dB(A)	37/33/31	37/34/31	41/36/33	41/36/33	43/39/34
	Sound power level(H/M/L)	dB(A)	48/44/42	48/45/42	52/47/44	52/47/44	54/50/45
	External dimensions(W/D/H)	mm	938/187/265	938/187/265	938/187/265	938/187/265	1046/239/299
Installation	Shipping dimensions(W/D/H)	mm	1016/304/360	1016/304/360	1016/304/360	1016/304/360	1111/329/373
	Net/Shipping weight	kg	10.9/13.1	10.9/13.1	10.9/13.1	10.9/13.1	13/16.5
	Refrigerant liquid pipe	mm	6.35	6.35	6.35	6.35	9.52
	Refrigerant gas pipe	mm	12.7	12.7	12.7	12.7	15.88
Controller	Wired (O-Optional/S-Standard)	/	YR-E16A(O)	YR-E16A(O)	YR-E16A(O)	YR-E16A(O)	YR-E16A(O)
	Infrared(O-Optional/S-Standard)	/	YR-E17(S)	YR-E17(S)	YR-E17(S)	YR-E17(S)	YR-E17(S)
		/	YR-E16(O)	YR-E16(O)	YR-E16(O)	YR-E16(O)	YR-E16(O)
		/	YR-E17(S)	YR-E17(S)	YR-E17(S)	YR-E17(S)	YR-E17(S)







MRV INDOOR

Ventilation

143 VENTILATION
Duct Fresh Air
HRV

DUCT FRESH AIR

-  **AD482MPERA**
-  **AD722MPERA**
-  **AD962MPERA**



- Variable static pressure 100~200Pa setting
- Install with other indoor units together, and introduce the outdoor fresh air into indoor

HRV

- ERV0150ANN**
- ERV0260ANN**
- ERV0800ANN**
- ERV1000ANN**



YR-N07(S)

- Be controlled with other indoor units together
- Efficient heat recovery air processing
- Heat recovery media element



Model/Indoor unit			AD482MPERA	AD722MPERA	AD962MPERA
Capacity	Cooling	kBtu/h	47.7	77.1	95.5
		kW	14	22.6	28
	Heating	Btu/h	30.4	51.8	60.8
kW		8.9	15.2	17.8	
Electrical Parameters	Power supply	Ph/V/Hz	1/220-230/50/60	1/220-230/50/60	1/220-230/50/60
	Air flow (H)	m³/h	1600	2300	2800
Performance	Sound pressure level(H/M/L)	dB(A)	48	55	55
	Sound power level(H/M/L)	dB(A)	61	68	68
Installation	External dimensions(W/D/H)	mm	1355/876/360	1725/876/360	1725/876/360
	Shipping dimensions(W/D/H)	mm	1386/966/418	1830/990/530	1830/990/530
	Net/Shipping weight	kg	62/77	92/100	92/100
	Refrigerant liquid pipe	mm	9.52	9.52	9.52
	Refrigerant gas pipe	mm	15.88	25.4	25.4
	Static Pressure(Standard/Max.)	Pa	100/185	100/200	100/200
Controller		/	YR-E16A(O)	YR-E16A(O)	YR-E16A(O)
	Wired (O-Optional/S-Standard)	/	YR-E16(O)	YR-E16(O)	YR-E16(O)
		/	YR-E17(S)	YR-E17(S)	YR-E17(S)
	Infrared(O-Optional/S-Standard)	/	YR-HD(O)	YR-HD(O)	YR-HD(O)



Model/Indoor unit			ERV0150ANN	ERV0260ANN	ERV0800ANN	ERV1000ANN
Electrical	Power supply	Ph/V/Hz	1/220-230/50/60	1/220-230/50/60	1/220-230/50/60	1/220-230/50/60
	Rated power input	kW	0.1	0.12	0.36	0.36
	Rated current	A	0.55	0.55	1.65	1.65
Performance	Air flow (H)	m³/h	150	260	800	1000
	Sound pressure level(H/L)	dB(A)	44/43	44/43	57/55	57/55
	Sound power level(H/L)	dB(A)	55/54	55/54	68/66	68/66
Installation	External dimensions(W/D/H)	mm	940/685/276	940/685/276	1227/1115/387	1227/1115/387
	Shipping dimensions(W/D/H)	mm	1013/773/345	1013/773/345	1465/1213/430	1465/1213/430
	Net/Shipping weight	kg	28.7/31.2	28.7/31.2	85.5/90.6	85.5/90.6
Controller	Static Pressure	Pa	80	60	120	100
	Wired (O-Optional/S-Standard)	/	YR-N07(S)	YR-N07(S)	YR-N07(S)	YR-N07(S)
	Infrared(O-Optional/S-Standard)	/	/	/	/	/



MRV INDOOR

Easy MRV Indoor

147 EASY MRV INDOOR
High Wall
Console

HIGH WALL

- AS07QS2ERA
- AS09QS2ERA
- AS12QS2ERA



YR-HD(S)

- 3D-cant lifting panel
- 6 color lights concealed LED display
- Nano-aqua
- 3D airflow

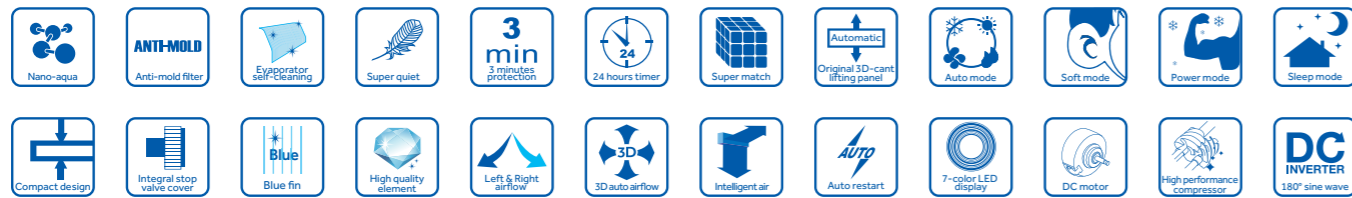

Model/indoor unit			AS07QS2ERA	AS09QS2ERA	AS12QS2ERA	
Capacity	Nominal cooling	Btu/h(nor)	6800	9000	11950	
		kW nominal(min-max)	2	2.63(0.9-3.1)	3.5(1.2-3.8)	
	Nominal heating	Btu/h(nor)	7850	9220	12290	
		kW nominal(min-max)	2.3	2.7(1.2-3.1)	3.6(1.3-4.0)	
	Heating P design(-10°C)	kW	2.5	2.5	3.1	
Electrical parameters	Power supply	Ph/V/Hz	1/230/50	1/230/50	1/230/50	
	Performance	Air flow(H/M/L)	m ³ /h	600	600	620
		Sound power level(H/M/L)	dB(A)	51	51	53
Installation	Sound pressure level(H/M/L)	dB(A)	34/30/24/22	34/30/24/22	35/30/25/23	
		External dimensions(W/D/H)	mm	860/175/285	860/175/285	860/175/285
	Shipping dimensions(W/D/H)	mm	938/265/360	938/265/360	938/265/360	
	Net/Shipping weight	kg	10/11.7	10/11.7	10/11.7	
	Refrigerant liquid pipe	mm	6.35	6.35	6.35	
	Refrigerant gas pipe	mm	9.52	9.52	9.52	
	Controller	Standard		YR-HD(S)	YR-HD(S)	YR-HD(S)
Option		Please refer to Super Match Catalogue				

HIGH WALL

- AS07NS1HRA
- AS09NS1HRA
- AS12NS1HRA
- AS15NS1HRA
- AS18NS1HRA
- AS24NS1HRA



YR-HD(S)

- Super quiet 22dB(A)
- Nano-aqua
- 3D airflow
- Long distance air supplying
- A-PAM inverter technology



Model/indoor unit			AS07NS1HRA	AS09NS1HRA	AS12NS1HRA	AS15NS1HRA*	AS18NS1HRA	AS24NS1HRA	
Capacity	Nominal cooling	Btu/h(nor)	6800	9210	12290	15010	17740	23890	
		kW nominal(min-max)	2	2.7 (0.80-3.40)	3.6(1.00-4.20)	4.4(1.3-5.0)	5.2(1.30-6.80)	7.0(2.20-8.50)	
	Nominal heating	Btu/h(nor)	7850	9560(4780-10920)	12630(4780-13990)	18430(4780-20480)	19790(5460-20480)	25600(8530-26620)	
		kW nominal(min-max)	2.3	2.8(1.00-4.60)	3.7(1.100-5.40)	5.4(1.4-6.0)	5.8(1.40-6.90)	7.5(2.40-9.80)	
	Heating P design(-10°C)	kW	2.5	2.5	3.2	3.5	4.9	5.1	
Electrical parameters	Power supply	Ph/V/Hz	1-230-50	1-230-50	1-230-50		1-230-50	1-230-50	
	Performance	Air flow(H/M/L)	m ³ /h	600	600	650	700	900	1200
		Sound power level(H/M/L)	dB(A)	52	52	54	55	57	62
Installation	Sound pressure level(H/M/L)	dB(A)	39/34/27/21	39/34/27/21	40/35/31/22	44/40/35/28	47/43/37/30	47/43/37/35	
		External dimensions(W/D/H)	mm	855X204X280	855X204X280	855X204X280	900×210×310	997×235×322	1115×248×336
	Shipping dimensions(W/D/H)	mm	954×279×355	954×279×355	954×279×355	991×313×399	1085×329×403	1205×341×416	
	Net/Shipping weight	kg	10/12.2	10/12.2	10/12.2	11.5/14	13/16	16/19.6	
	Refrigerant liquid pipe	mm	6.35	6.35	6.35	6.35	9.52	9.52	
	Refrigerant gas pipe	mm	9.52	9.52	9.52	12.7	15.88	15.88	
	Controller	Standard		YR-HD(S)	YR-HD(S)	YR-HD(S)	YR-HD(S)	YR-HD(S)	YR-HD(S)
Option		Please refer to Super Match Catalogue							

HIGH WALL

- AS07BS4HRA
- AS09BS4HRA
- AS12BS4HRA
- AS15BS4HRA*
- AS18BS4HRA
- AS24BS4HRA



YR-HD(S)

- Super quiet 22dB(A)
- Long distance air supplying
- A-PAM inverter technology



Model/indoor unit			AS07BS4HRA	AS09BS4HRA	AS12BS4HRA	AS15BS4HRA*	AS18BS4HRA	AS24BS4HRA
Capacity	Nominal cooling	Btu/h(nor)	6800	9210	12290	15010	17740	23890
		kW nominal(min-max)	2	2.7 (0.80-3.40)	3.6(1.00-4.20)	4.4(1.3-5.0)	5.2(1.30-6.80)	7.0(2.20-8.50)
	Nominal heating	Btu/h(nor)	7850	9560(4780-10920)	12630(4780-13990)	18430(4780-20480)	19790(5460-20480)	25600(8530-26620)
		kW nominal(min-max)	2.3	2.8(1.00-4.60)	3.7(1.100-5.40)	5.4(1.4-6.0)	5.8(1.40-6.90)	7.5(2.40-9.80)
	Cooling P design(35°C)	kW	2.7	2.7	3.6	4.4	5.2	7
Heating P design(-10°C)	kW	2.5	2.5	3.2	3.5	4.9	5.1	
Electrical parameters	Power supply	Ph/V/Hz	1-230-50	1-230-50	1-230-50	1-230-50	1-230-50	1-230-50
Performance	Air flow(H/M/L)	m³/h	600	600	650	700	900	1200
	Sound power level(H/M/L)	dB(A)	52	52	54	55	57	62
	Sound pressure level(H/M/L)	dB(A)	39/34/27/21	39/34/27/21	40/35/31/22	44/40/35/28	47/43/37/30	47/43/37/35
Installation	External dimensions(W/D/H)	mm	855X204X280	855X204X280	855X204X280	900×210×310	997×235×322	1115×248×336
	Shipping dimensions(W/D/H)	mm	954×279×355	954×279×355	954×279×355	991×313×399	1085×329×403	1205×341×416
	Net/Shipping weight	kg	10/12.2	10/12.2	10/12.2	11.5/14	13/16	16/19.6
	Refrigerant liquid pipe	mm	6.35	6.35	6.35	6.35	9.52	9.52
	Refrigerant gas pipe	mm	9.52	9.52	9.52	12.7	15.88	15.88
	Controller	Standard		YR-HD(S)	YR-HD(S)	YR-HD(S)	YR-HD(S)	YR-HD(S)
Option			Please refer to Super Match Catalogue					

* Models are under development, data is pending;

HIGH WALL

- AS07ZB1HRA
- AS09ZB1HRA
- AS12ZB1HRA
- AS18ZD1HRA
- AS24ZE1HRA



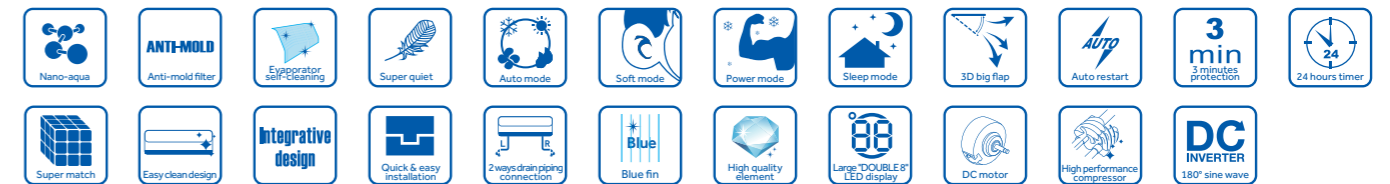

YR-HD(S)

- Super quiet
- Negative ion
- Long distance air supplying
- A-PAM inverter technology



Model/indoor unit			AS07ZB1HRA	AS09ZB1HRA	AS12ZB1HRA	AS18ZD1HRA	AS24ZE1HRA
Capacity	Nominal cooling	Btu/h(nor)	6830	9210	12290	17740	23890
		kW nominal(min-max)	2(1.1-2.9)	2.7 (0.9-3.2)	3.6(1.40-3.90)	5.2(1.50-5.60)	7.0(2.0-7.3)
	Nominal heating	Btu/h(nor)	7510	9560	12630	19790	25600
		kW nominal(min-max)	2.2(1.3-3.2)	2.8(1.4-3.2)	3.7(1.40-4.1)	5.8(1.6-6.0)	7.5(2.5-7.8)
	Cooling P design(35°C)	kW	2.0	2.7	3.6	5.2	7
Heating P design(-10°C)	kW	2.0	2.4	3.2	5.2	5.6	
Electrical parameters	Power supply	Ph/V/Hz	1/230/50	1-230-50	1-230-50	1-230-50	1-230-50
Performance	Air flow(H/M/L)	m³/h	630	630	700	900	1200
	Sound power level(H/M/L)	dB(A)	53	53	55	58	63
	Sound pressure level(H/M/L)	dB(A)	39/33/26/23	39/33/26/23	40/35/27/24	45/40/35/33	48/44/37/36
Installation	External dimensions(W/D/H)	mm	805/205/272	805/205/272	805/205/272	960/235/310	1085/245/330
	Shipping dimensions(W/D/H)	mm	900/280/335	900/280/335	900/280/335	1051/328/390	1175/341/416
	Net/Shipping weight	kg	8.6/10.8	8.6/10.8	8.6/10.8	11.7/13.9	14.6/17.8
	Refrigerant liquid pipe	mm	6.35	6.35	6.35	6.35	9.52
	Refrigerant gas pipe	mm	9.52	9.52	9.52	12.7	15.88
	Controller	Standard		YR-HD(S)	YR-HD(S)	YR-HD(S)	YR-HD(S)
Option			Please refer to Super Match Catalogue				

CONSOLE TYPE

-  AF09AS1ERA
-  AF12AS1ERA



YR-HD(S)

- High efficiency filter
- Quiet running
- Compact design
- Fast temp. adjustment
- Blowing up and down



Model/indoor unit		AF09AS1ERA	AF12AS1ERA	
Capacity	Nominal cooling	Btu/h(nor)	8500	12000
		kW nominal(min-max)	2.5(1.3-3.0)	3.5(1.4-4.0)
	Nominal heating	Btu/h(nor)	9550	13000
		kW nominal(min-max)	2.8(1.4-3.2)	3.80(1.4-4.1)
Electrical parameters	Cooling P design(35°C)	kW	2.5	3.5
	Heating P design(-10°C)	kW	2.1	2.7
Performance	Power supply	Ph/V/Hz	1/230/50	1/230/50
	Air flow(H/M/L)	m³/h	450	500
	Sound power level(H/M/L)	dB(A)	53	54
	Sound pressure level(H/M/L)	dB(A)	39/35/30/26	40/36/32/28
Installation	External dimensions(W/D/H)	mm	720x253x640	720x253x640
	Shipping dimensions(W/D/H)	mm	784x305x719	784x305x719
	Net/Shipping weight	kg	17/19.5	17.5/20
	Refrigerant liquid pipe	mm	6.35	6.35
	Refrigerant gas pipe	mm	9.52	9.52
Controller	Standard	YR-HD(S)	YR-HD(S)	
	Option	Please refer to control system in page 26		





CONTROL SYSTEM

- | 157 Star Products
- | 161 Individual Controller
- | 165 Centralized Controller
- | 167 BMS
- | 173 Reference Projects



CONTROL SYSTEM STRUCTURE



CONTROL SYSTEM

User Friendly Management Control Solution

Integrated Management

Convenient and efficient, Haier controllers realize the co-management of Super match and MRV in one system, providing you more combination choices for better managing large or middle-sized buildings.

Building Management

The excellent building management system provides a professional and reliable service for a better management of your air conditioning units.

Intelligent Management

"Haier Smart AC" provides an intelligent and personalized experience for your smart life.

Applications

Haier control products are designed to provide you a perfect solution for the small, medium or large commercial projects.

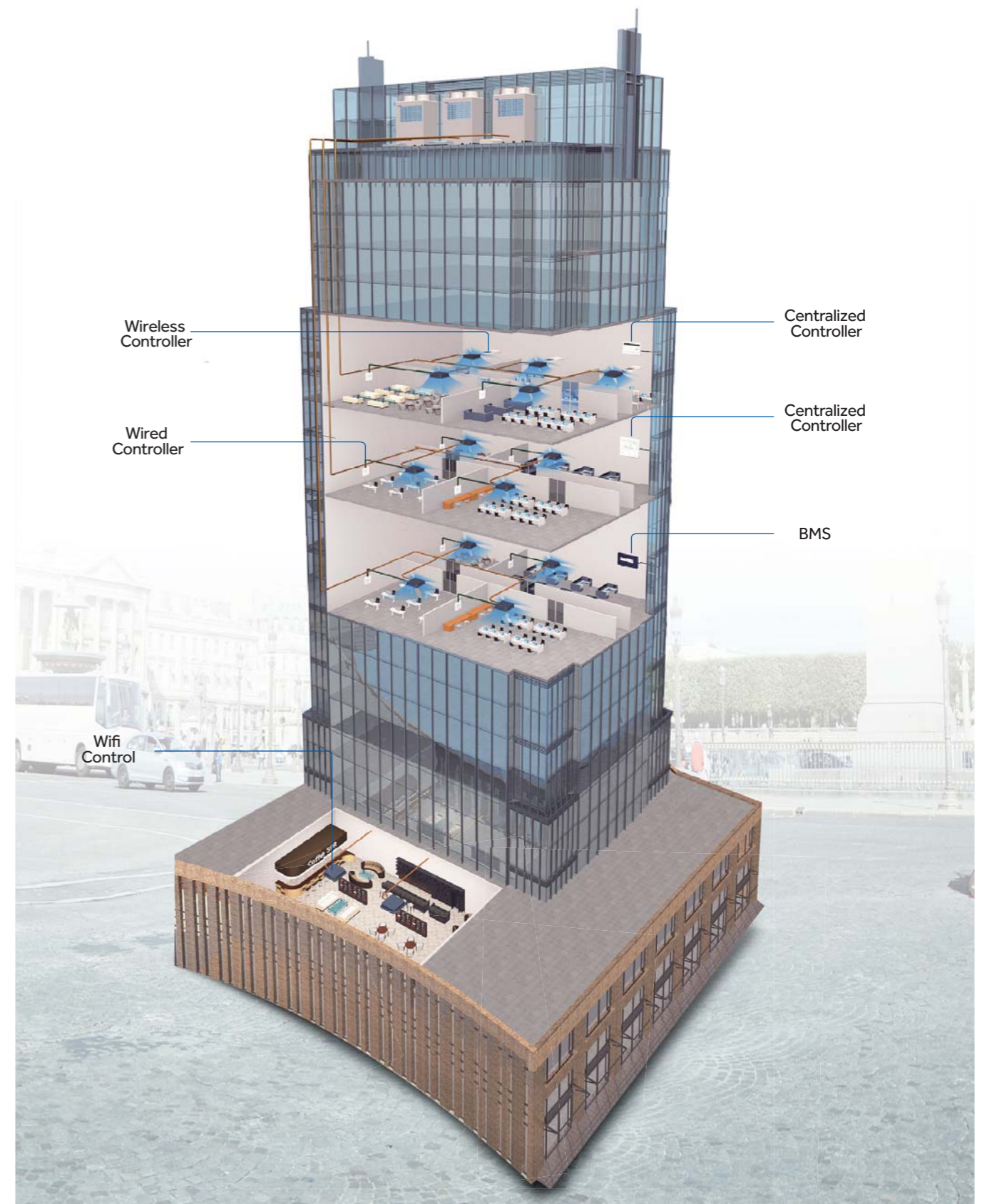

CONTROL SYSTEM

Star Products

YCZ-A004 is a smart touch screen controller enabling remote management of up to 256 indoor units.

YCZ-A004

- Individual control, Group control & Central control (Max 256 indoor units)
- 7-inch TFT LCD touch screen with back light
- Schedule control
- Operation mode lock
- Control mode setting (LIFO, Central, Lock)
- User editable control logic
- Indoor units' information edit
- Error display
- Fire alarm terminal
- Historical data backup



YCZ-A004 System

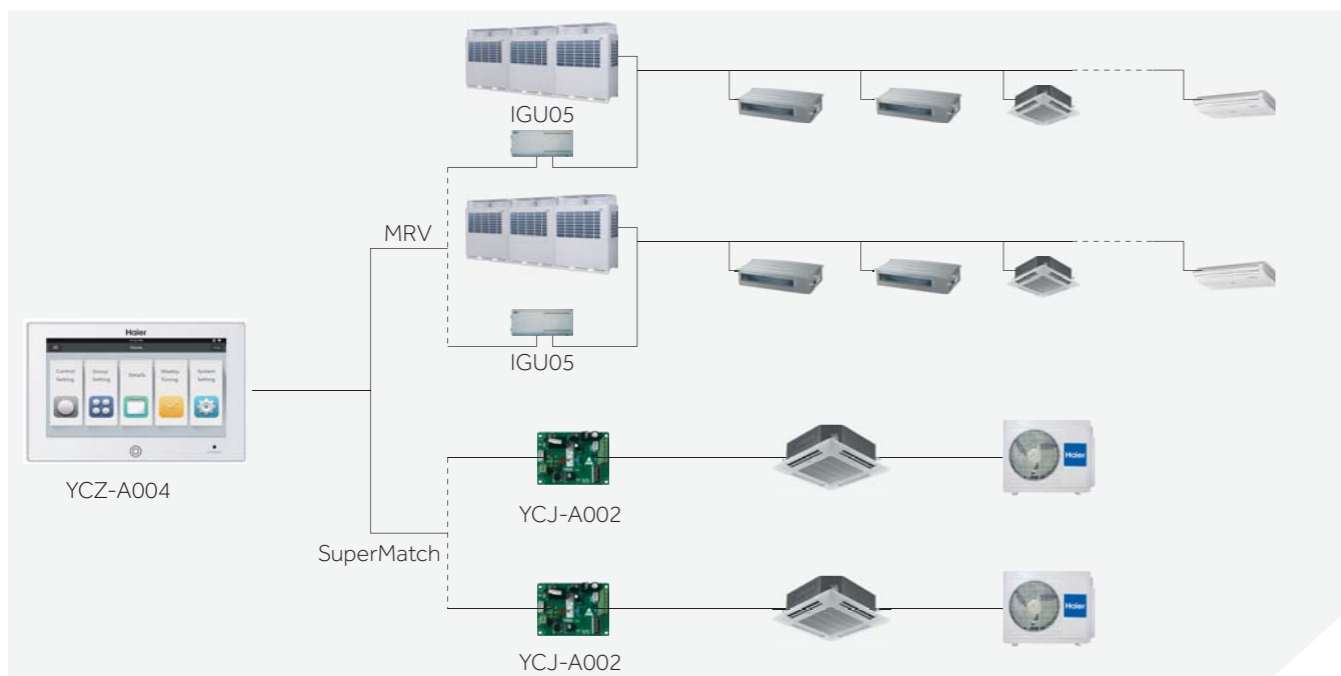

Control and Monitoring

- Control and monitoring up to 256 indoor units.
- Operation control: mode, temperature, fan, swing.
- All ON/OFF
- Icon based indoor units display

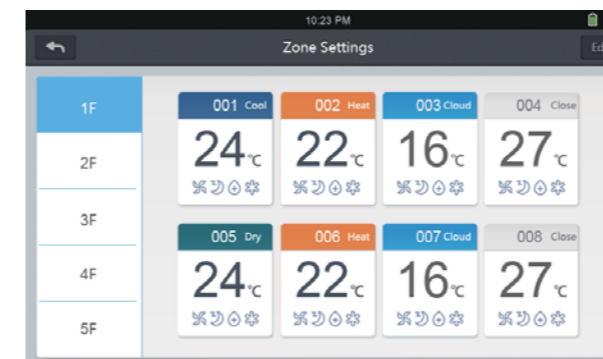

Zone Management

- Zoning control the indoor units according to user's demands.
- Zone control: zone creation, edition, deletion

User	Room	Ambient	Gas	Liquid	PMV	Mode	Fan	Running	Erro	XXXX
Name	No.	Temp.	Pipe	Pipe			Speed	Time	No.	
001										
002										
003										
004										
005										
006										
007										
008										

Cycle Monitoring

- Monitoring indoor unit running status

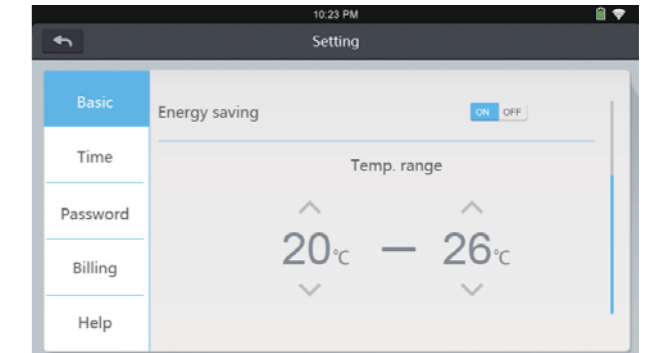

Energy Saving Function

- Operation mode lock
- Upper/lower temperature limit setting for different zones/ groups

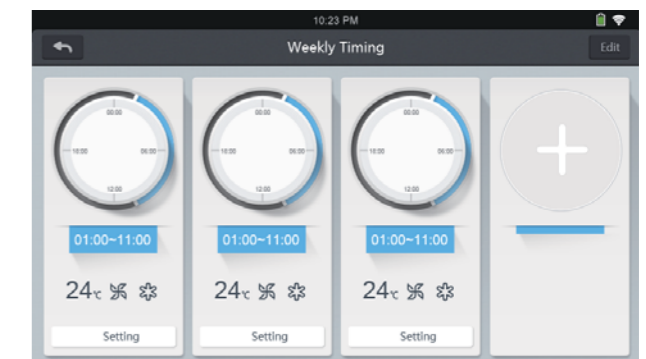

Schedule Control

- Weekly/ Daily schedule control without setting number limitation.
- Free combination
- Schedule edit (add, edit, delete)
- Detailed operation setting

Setting	Electricity report
001	
002	
003	
004	
005	
006	
007	
008	
009	
010	

Power Distribution & Report

- Data query
- Electricity report download.

CONTROL SYSTEM

Star Products

Powerful and integrated solution for medium or large commercial projects, enabling control of 250/500 indoor units.

HCM-05/HCM-05(A)

- Remote monitoring version
- Third party interface: BACnet ip
- Max. 250 indoor units can be controlled for HCM-05; and 500 indoor units for HCM-05(A)
- Max. 32 systems. Each system requires one IGU02.
- Operation status setting & monitoring.
- Schedule setting
- Multi user management with different authorized levels
- Electricity charge report
- Operation and Error history log
- Cooperated technology with Honeywell



HCM-05 System

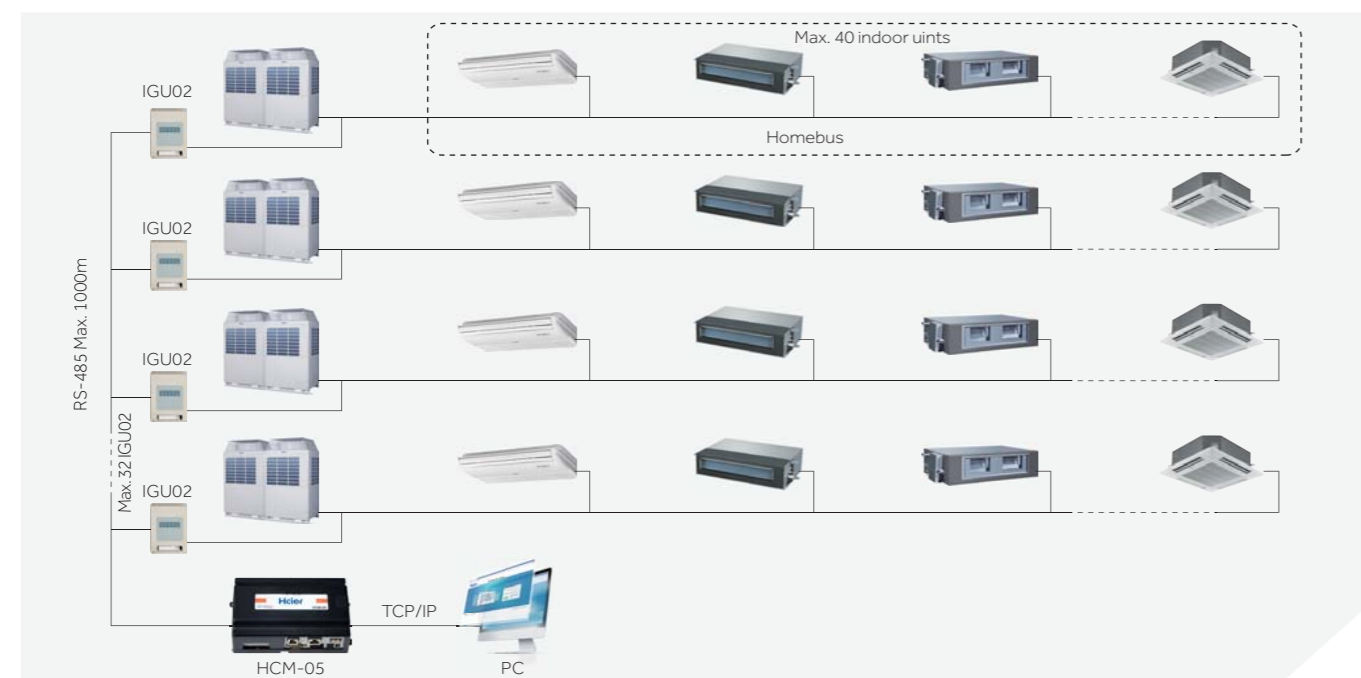

Control and Monitoring

- Control and monitoring up to 250/500 indoor units.
- Operation control: mode, temperature, fan, swing.
- Operation mode lock
- Control mode lock
- Icon based indoor units display

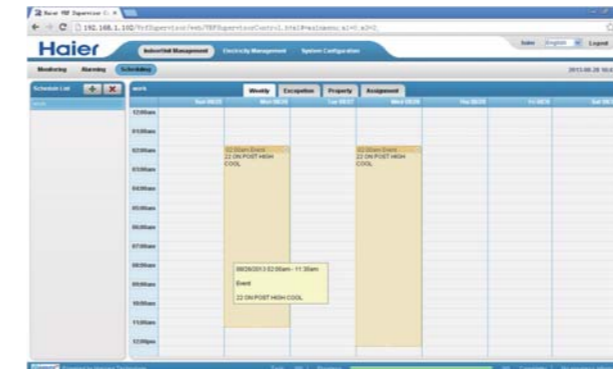

Schedule Control

- Graphical schedule setting
- Free combination
- Schedule edit (add, edit, delete)
- Exception day setting

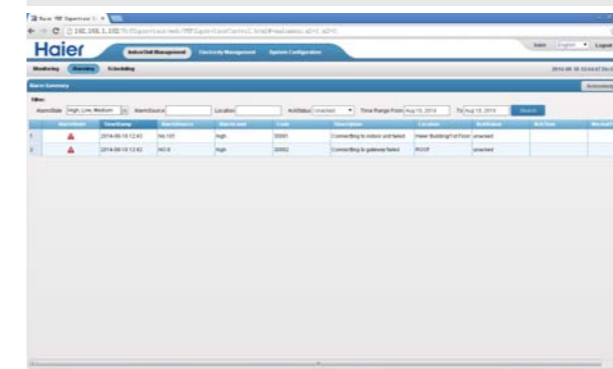

Error Management

- Error history management
- Detailed error information query

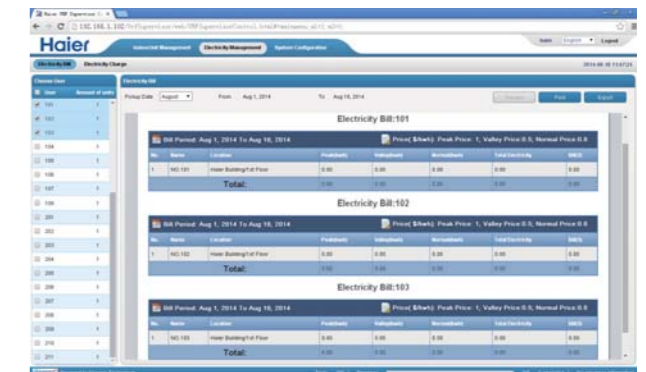

Power Distribution & Report

- Data query
- Electricity price setting for different time sections
- Electricity report preview, print and transmit
- Electricity charges prepaid & comparison

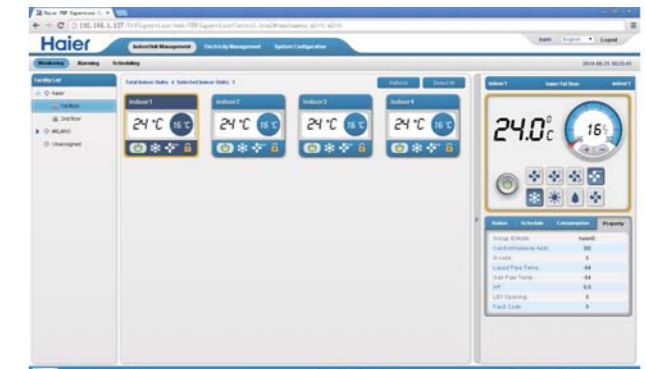

Zone Management

- Zoning control the indoor units according to user's demands
- Zone control: creation, edition, deletion

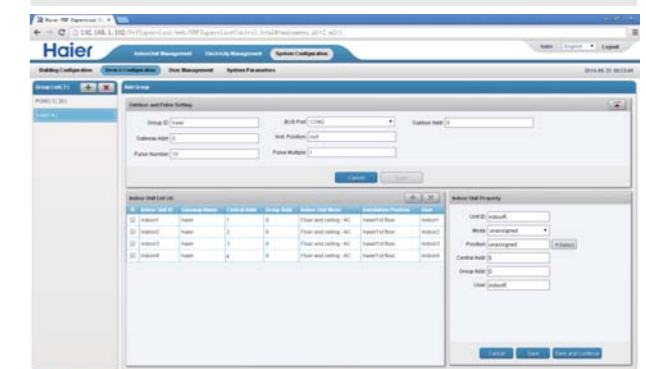

System Configuration

- Building configuration
- Device configuration
- User management
- System parameters

CONTROL SYSTEM

Individual Controller

The individual control system has a variety of wired and wireless controllers which enable you an easy and intelligent control of your air conditioners. You can choose the one which best suits for your air conditioning management.



YR-HBS01

- On/Off, Mode, Fan speed, Temperature setting, Swing
- Individual control
- Five grades fan speed reserved
- Individual blade control for Smart Power Cassette
- Clock & Timer



YR-HD

- On/Off, Mode, Fan speed, Temperature setting, Swing
- Individual control
- Timer
- Clock



YR-E17

- On/Off, Mode, Fan speed, Temperature setting, Swing.
- Individual & Group control (Max 16 indoor units)
- Simple and Smart design, 86*86*13.05mm
- Touch button with back light
- Timer /Clock
- Individual blade control for Smart Power Cassette
- Easy installation, user friendly



YR-E16A

- On/Off, Mode, Fan speed, Temperature setting, Swing
- Individual & Group control (Max 16 indoor units)
- Large touch button
- Fahrenheit/ Celsius selectable; Sensitivity $\pm 0.5^{\circ}\text{C}$ ($\pm 1^{\circ}\text{F}$)
- Individual blade control for Smart Power Cassette
- Static pressure setting
- Error display in sequence of date



CONTROL SYSTEM

Individual Controller

YR-F02

- On/Off, Mode, Fan speed, Temperature setting, Swing
- Individual control
- Group control, Max. 16 units
- Filter
- Check



WIFI Module (KZW-W001)

- Remote control: On/Off, Mode, Fan speed, Temperature setting, Swing.
- Individual & Group control (Max 16 indoor units)
- Cloud adaptation
- Weekly timer
- * A YCJ-A002 is required on some certain indoor units



RE-01/02

- Infrared signal receiver
- Realize the remote control of Duct type indoor unit

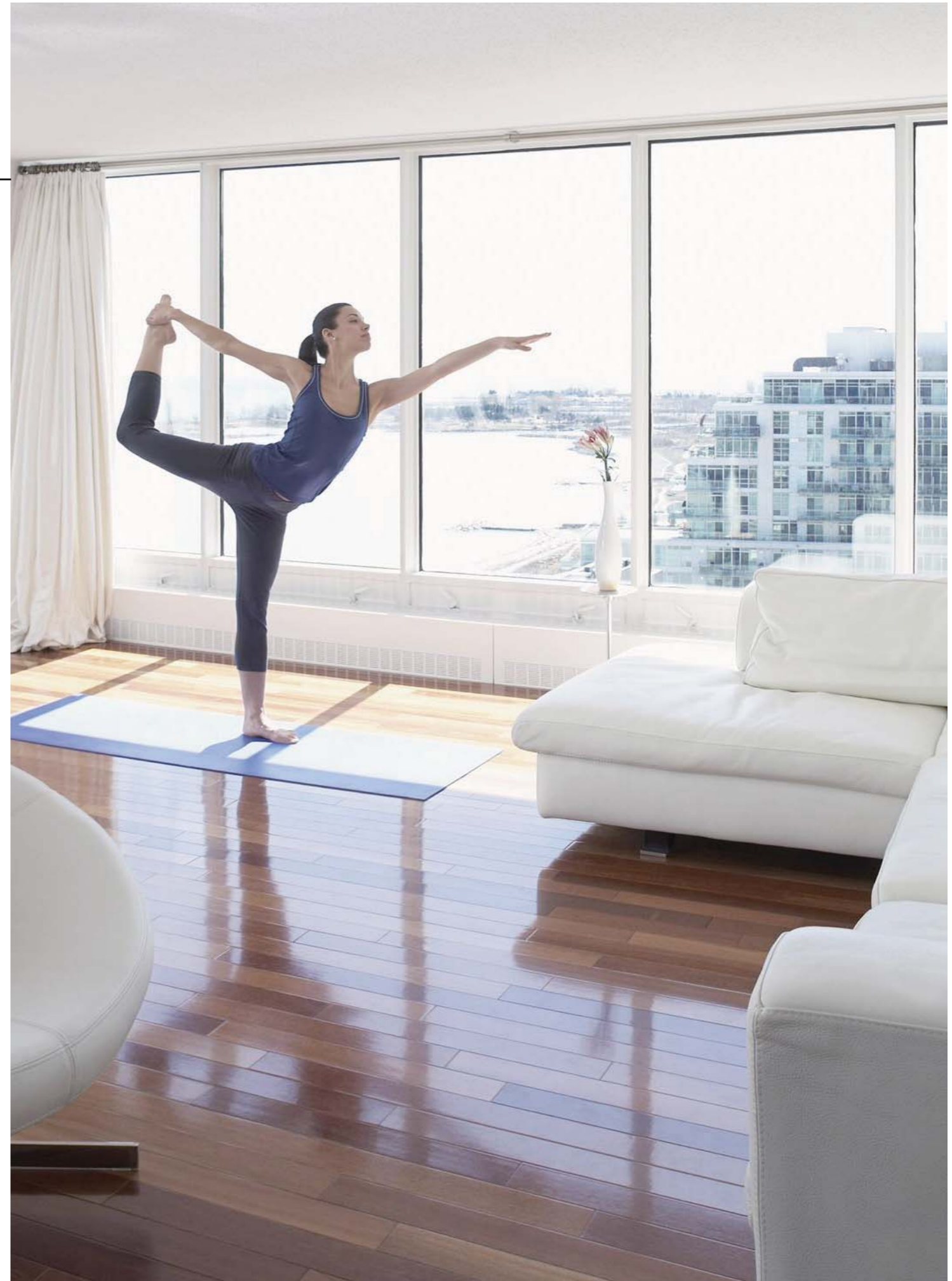

CONTROL SYSTEM

Centralized Controller

The centralized control system offers you a smart and convenient experience while managing your air conditioner individually or by groups or by zones. A variety of controllers can be used to perfect your air conditioning management.



YCZ-G001

- Individual control, Group control & Central control (Max 32 indoor units)
- Large touch key
- Weekly timer.
- Unit name & Group name free setting. Four background available (mall, hotel, office, home)
- Error display
- * Must be used in combination with an IGU05 for each MRV system (Max. 16 sets)



YCZ-A004

- Individual control, Group control & Central control (Max 256 indoor units)
- 7-inch TFT LCD touch screen with back light
- Schedule control
- Indoor units' information edit
- * Must be used in combination with an IGU05 for each MRV system. (Max. 32 sets)



YCZ-A003

- Individual control, Group control & Central control (Max 128 indoor units)
- Touch screen with back light
- Schedule control
- Error display
- * Must be used in combination with an IGU05 for each MRV system. (Max. 32 sets)



IGU05

- Protocol adapter, convert Homebus to RS-485
- Match with Central controller (YCZ-G001/A003/A004). An IGU05 can only be used in one system
- Max. 64 indoor units can be connected with one IGU05



CONTROL SYSTEM

BMS

The building management modules could perfectly integrate air conditioners into the Building Management System, providing an excellent solution for large commercial areas.



HCM-01

- Local control version; Convert RS-485 to RS-232
- Max. 400 indoor units can be controlled
- Max. 32 systems/ outdoor units, each system unit requires one IGU02.
- Operation status setting & monitoring.
- Schedule setting (weekly, monthly)
- Electricity charge report
- Operation and Error history log



HCM-01 System

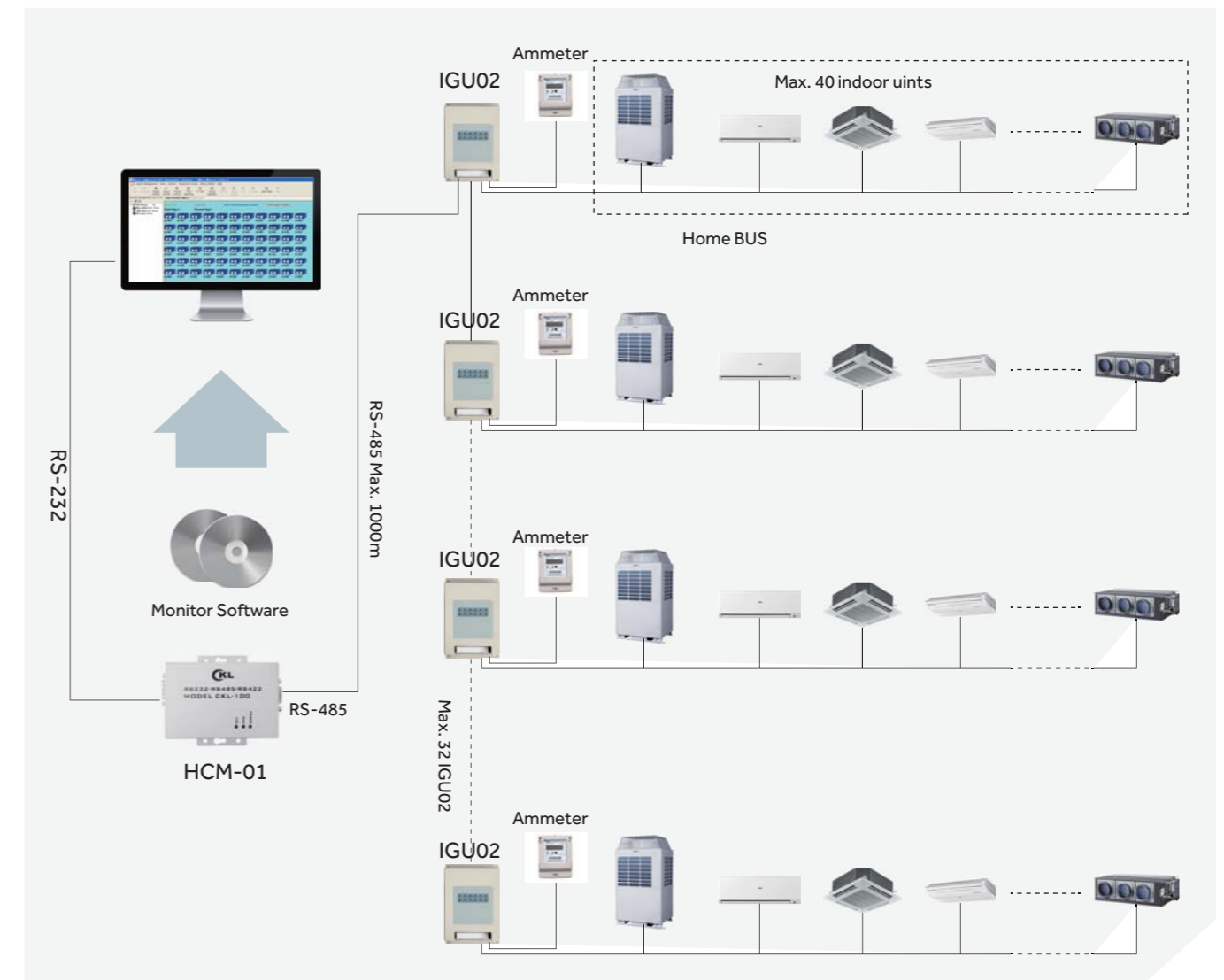

CONTROL SYSTEM

BMS

HCM-03

- Remote monitoring version: Third party interface: BACnet ip/ Modbus ip/ Modbus rtu
- Max. 1000 indoor units can be controlled
- Max. 4 groups. Each group can connect 20 systems. Each system requires one IGU02.
- Operation status setting & monitoring.
- Schedule setting (weekly, monthly)
- Multi user management with different authorized levels
- Operation and Error history log



HCM-03 System

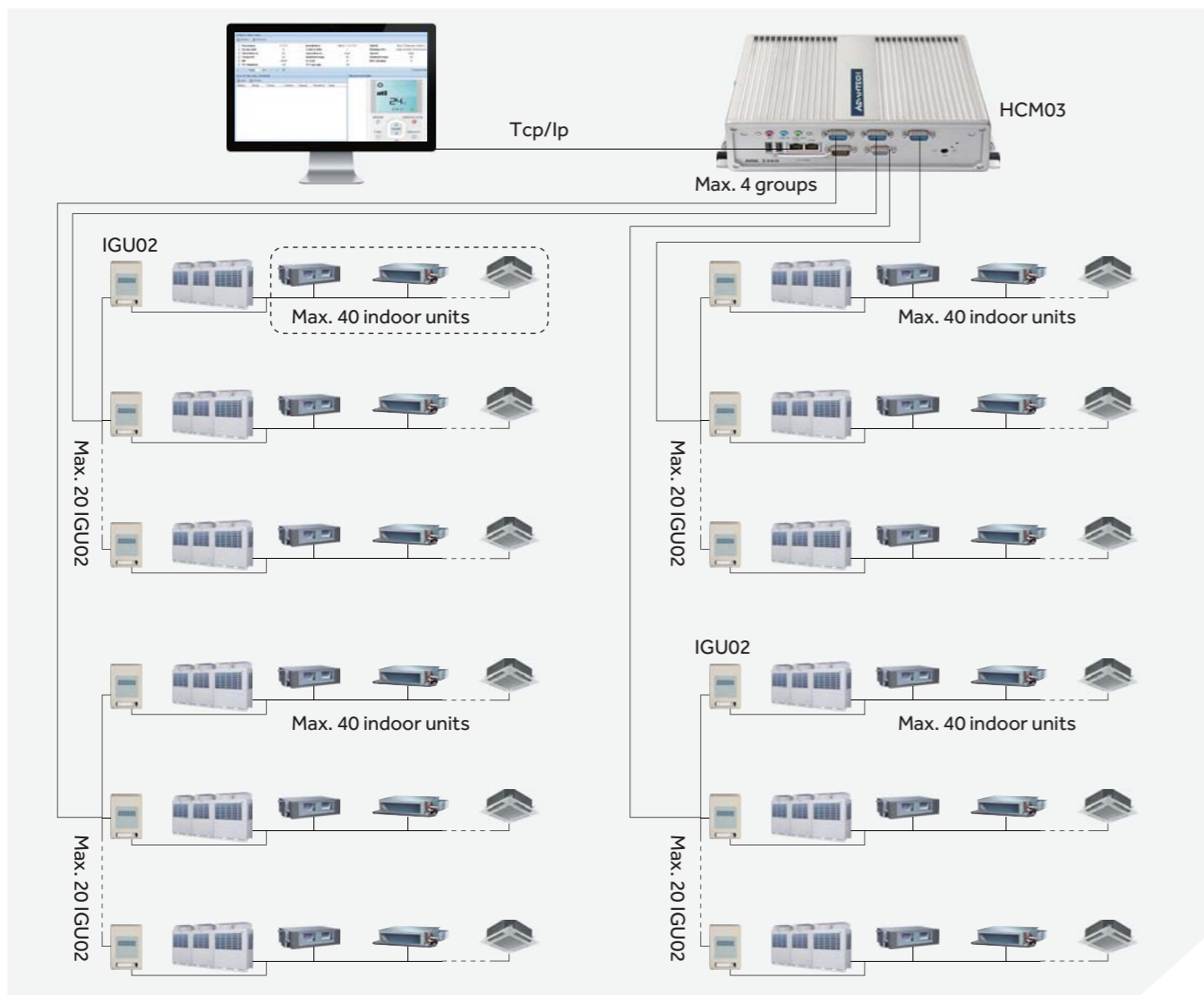

HCM-05/HCM-05(A)

- Third party interface: BACnet ip
- Max. 250 indoor units can be controlled for HCM-05; and 500 indoor units for HCM-05(A)
- Max. 32 systems. Each system requires one IGU02.
- Multi user management with different authorized levels
- Cooperated technology with Honeywell



IGU02

- Protocol adapter, convert Homebus to RS-485
- Match with BMS (HCM-01, 03, 05, 05A). Each system requires one IGU02
- Max. 40 indoor units can be connected with one IGU02
- Electricity data collection, calculation, allocation and storage.



Cloud Services Platform

- 7*24 Personalized Long-distance monitoring & service
- Malfunction alarm and error solving suggestions
- Power consumption data collection and analysis



Intelligent Cloud Services

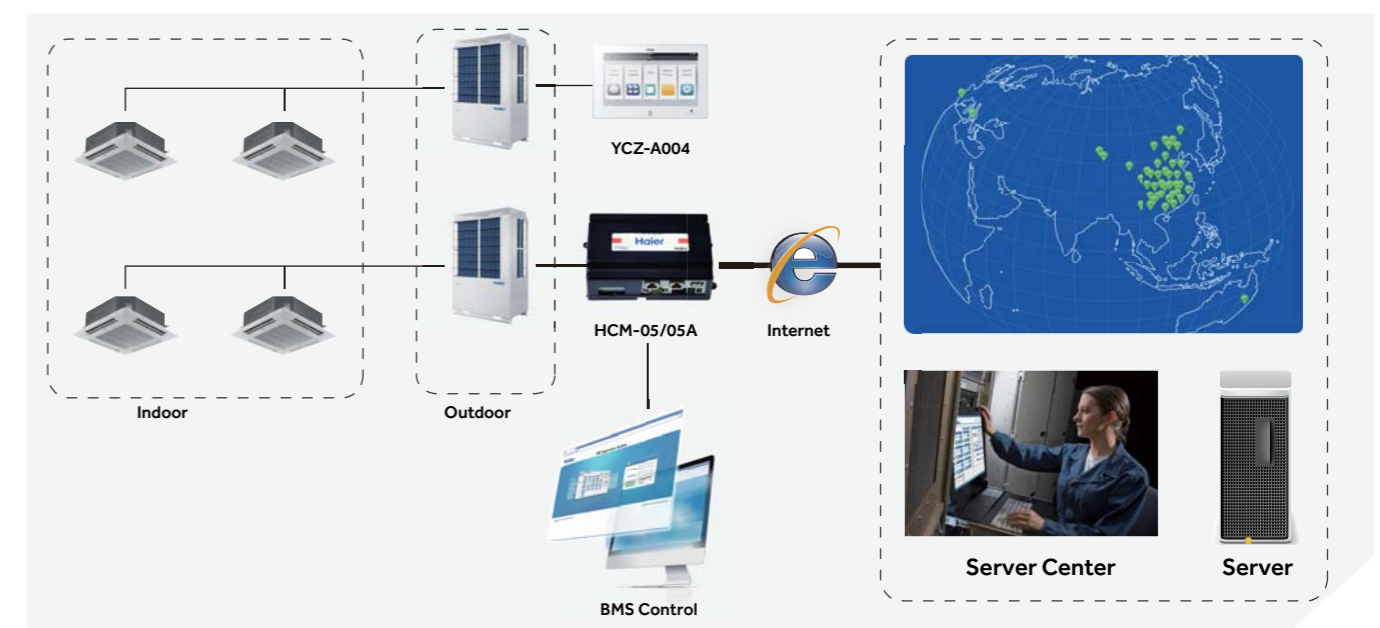

CONTROL SYSTEM

BMS

IGU06

- Protocol adapter, convert Homebus to Modbus
- Max. 64 indoor units can be controlled
- Match with IGU07 to realize the Lonworks gateway function
- Max. 32 indoor units can be connected with one IGU06 when connecting with the IGU07



IGU07

- Protocol adapter, convert Modbus to Lonworks
- Each system requires one IGU07 + IGU06
- Max. 32 indoor units can be connected in one system
- External 24V DC power supply is needed by IGU07.



HA-WA1

- Gateway: Modbus rtu
- Protocol adapter: Convert Homebus to RS-485
- Max. 64 indoor units can be connected with one AD-GA1
- Replacement of IGU05
- *Designed to be launched on June, 2016



LonWorks System

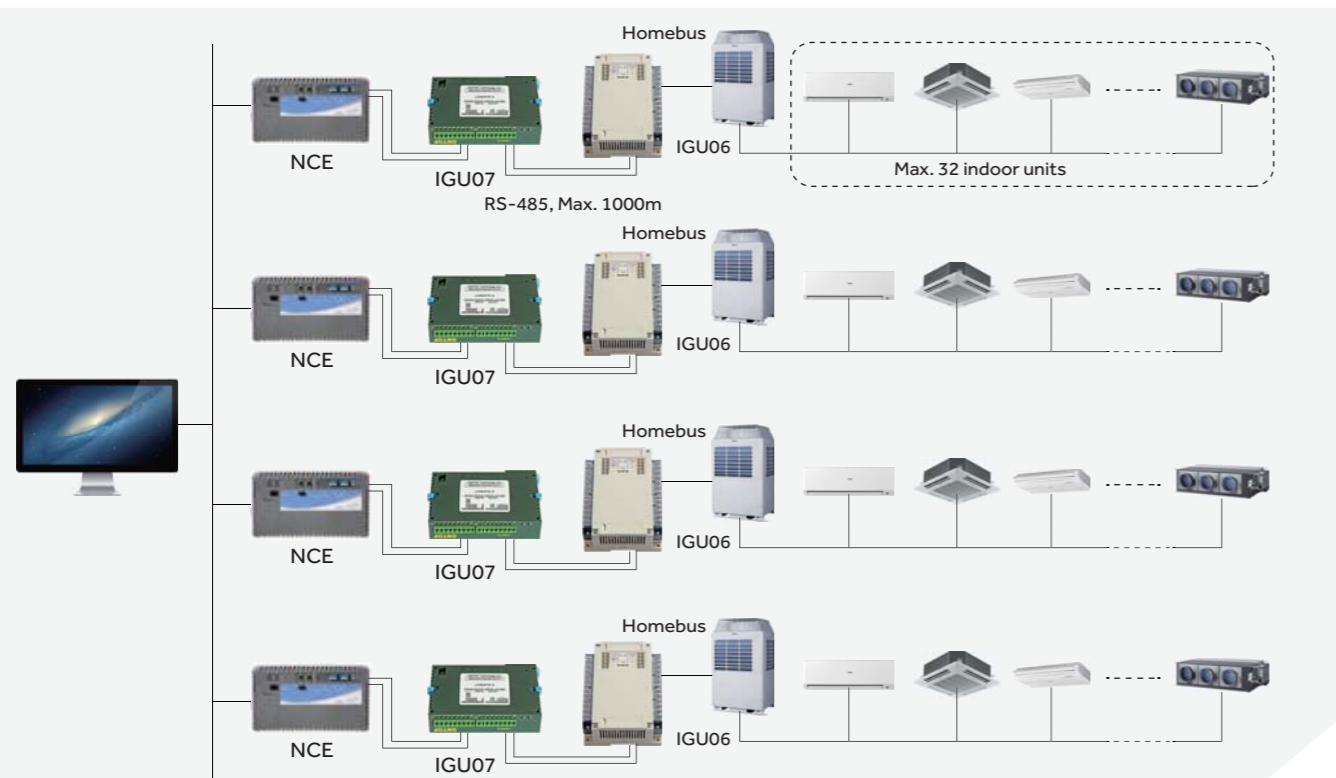

Accessories

Name	Design	Model	Functions	For what units
Gather pipe		HZG-20A	Refrigerant gathering	2 outdoor units
Gather pipe		HZG-30A	Refrigerant gathering	3 outdoor units
Gather pipe		HZG-20B	Refrigerant gathering	MRV IV-C, 2 outdoor units
Gather pipe		HZG-30B	Refrigerant gathering	MRV IV-C, 3 outdoor units
Gather pipe		HZG-R20A	Refrigerant gathering for heat recovery MRV	2 outdoor units
Gather pipe		HZG-R30A	Refrigerant gathering for heat recovery MRV	3 outdoor units
Manifold pipe		FQG-B335A	Refrigerant distribution for heat pump MRV	Total indoor units capacity less than 33,500W
Manifold pipe		FQG-B506A	Refrigerant distribution for heat pump MRV	Total indoor units capacity less than 50,600W, but equal or bigger than 33,500W
Manifold pipe		FQG-B730A	Refrigerant distribution for heat pump MRV	Total indoor units capacity less than 73,000W, but equal or bigger than 50,600W
Manifold pipe		FQG-B1350A	Refrigerant distribution for heat pump MRV	Total indoor units capacity bigger than 73,000W
Manifold pipe		FQG-R335A	Refrigerant distribution for heat recovery MRV	Total indoor units capacity less than 33,500W
Manifold pipe		FQG-R506A	Refrigerant distribution for heat recovery MRV	Total indoor units capacity less than 50,600W, but equal or bigger than 33,500W
Manifold pipe		FQG-R730A	Refrigerant distribution for heat recovery MRV	Total indoor units capacity less than 73,000W, but equal or bigger than 50,600W
Manifold pipe		FQG-R1350A	Refrigerant distribution for heat recovery MRV	Total indoor units capacity less than 135,000W, but equal or bigger than 73,000W
Manifold pipe		FQG-B2040A	Refrigerant distribution for MRV IV-C	Total indoor capacity > 135,000 W
VP box		VP1-112A	Vavle pipe box	MRV III-RC(heat recovery)
VP box		VP1-180A	Vavle pipe box	MRV III-RC(heat recovery)
VP box		VP1-280A	Vavle pipe box	MRV III-RC(heat recovery)

REFERENCE PROJECTS

Country: Algeria

Project Name: Hotel-amillia bab ezzouar
Product Series: MRVII-C



Country: Algeria

Project Name: AGB Bank
Product Series: MRVII-C

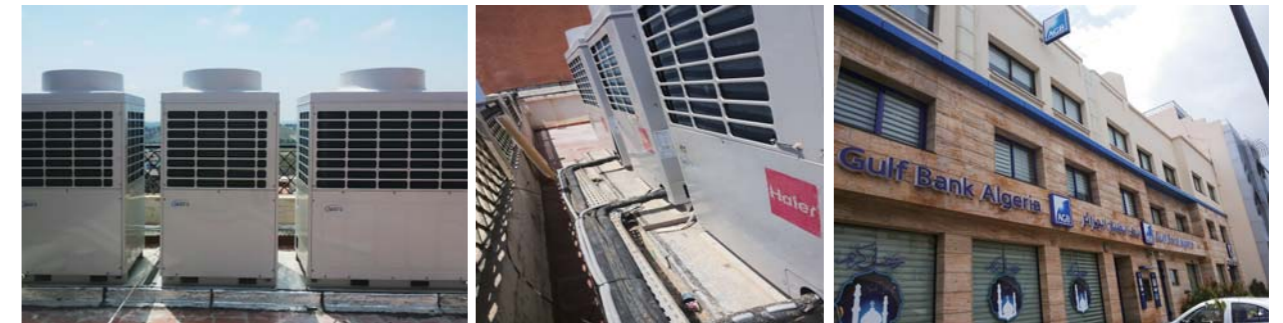

Country: Algeria

Project Name: Hotel-Akbou Bedjaia
Product Series: MRVII-C&MRVIII-C



Country: Algeria

Project Name: Al Qods
Product Series: MRVII



Country: Algeria

Project Name: Invest Inox Office
Product Series: MRVII



REFERENCE PROJECTS

Country: Algeria

Project Name: Mole Fix Office
Product Series: MRVII-C



Country: Algeria

Project Name: PPT Tipaza Office
Product Series: MRVII-C



Country: Algeria

Project Name: Ofarco Office
Product Series: MRVII-S



Country: Algeria

Project Name: Telecom Com Office
Product Series: MRVII-C



REFERENCE PROJECTS

Country: Algeria

Project Name: Mobil Art
Product Series: MRV-S&MRVIII



Country: Algeria

Project Name: Tapis office and showroom
Product Series: MRVII-C



REFERENCE PROJECTS

Country: Algeria

Project Name: Tapis office and showroom
Product Series: MRV-C



Country: Angola

Project Name: Cabinda Stadium
Product Series: MRVII-C



Country: Bulgaria

Project Name: Varna Tower
Product Series: MRVII-C



REFERENCE PROJECTS

Country: Czech Republic

Project name: Geosan Group
Product series: MRVIII-C



Country: Czech Republic

Project name: National digital archiv
Product series: MRVII-C



Country: Czech Republic

Project name: ZZN Polabi
Product series: MRVIII-C



Country: Cyprus

Project Name: Avlogyros
Product Series: MRVII-C2



Project Name: Church at Ayios Theodoros
Product Series: MRVII-C2



Project Name: Coop Kato Varosion
Product Series: MRV-C



REFERENCE PROJECTS

Country: Cyprus

Project Name: House at Pyla Near CTO
Product Series: MRVII-C2



Project Name: Viva Souvenir Shop Ayia Napa
Product Series: MRVII-C2



Project Name: Ydroyios Insurance
Product Series: MRV-C



Country: Hungary

Project Name: National Institute
Product Series: MRVII-C



Project Name: Cordia City Garden Budapest
Product Series: MRVII-C



Project Name: DEC Oncology Medical Center, Debrecen
Product Series: MRVII-C



REFERENCE PROJECTS

Country: Italy

Project Name: Venpa, Brescia
Product Series: MRVII-C



Project Name: Restaurant Hotel Costrz
Product Series: MRVII-C



Project Name: Autosalone(BS)
Product Series: MRVII-C



Country: Iran

Project Name: Jewelry Factory, Mr. Anaraki
Product Series: MRV-III



Country: Iran

Project Name: Ebrahimi's Carpet gallery
Product Series: MRV-III



Country: Iran

Project Name: Takbiri's House
Product Series: MRVII-C2



REFERENCE PROJECTS

Country: Laos

Project Name: Lao President Palace
Product Series: MRVII-C



Country: Mauritius

Project Name: EBENE SKIES-port Louis
Product Series: MRVII-C



Country: Mauritius

Project Name: Eben Skies
Product Series: MRVII-C



Country: Mauritius

Project Name: Mr. Bricolage
Product Series: MRVIII-C & HCM-03



Country: Mauritius

Project Name: Precigraph
Product Series: MRVII-C



REFERENCE PROJECTS

Country: Nigeria

Project Name: Takyi Plaza
Product Series: MRVII-C



Country: Pakistan

Project Name: BNU University
Product Series: MRVIII



Country: Pakistan

Project Name: Barat Ghar
Product Series: MRVII-C



Country: Pakistan

Project Name: Shapes Health club
Product Series: MRVIII



Country: Pakistan

Project Name: Such TV
Product Series: MRVIII



REFERENCE PROJECTS

Country: Pakistan

Project Name: CNS Head Office
Product Series: MRVIII-C



Country: Pakistan

Project Name: Interloop
Product Series: MRVIII-C



Country: Pakistan

Project Name: Centaurus
Product Series: MRVIII-C



Country: Vietnam

Project Name: Nissan Centre
Product Series: MRVII-C



